OpenVMS RTL Screen Management (SMG\$) Manual

Order Number: AA-PV6LD-TK

April 2001

This manual documents the screen management routines contained in the SMG\$ facility of the OpenVMS Run-Time Library.

Revision/Update Information: This manual supersedes the *OpenVMS RTL Screen Management (SMG\$) Manual*, OpenVMS Alpha Version 7.1 and OpenVMS VAX Version 7.1.

Software Version: OpenVMS Alpha Version 7.3
OpenVMS VAX Version 7.3

**Compaq Computer Corporation
Houston, Texas**

© 2001 Compaq Computer Corporation

Compaq, VAX, VMS, and the Compaq logo Registered in U.S. Patent and Trademark Office.

Compaq Ada, DECnet, DECwindows, OpenVMS, and VT are trademarks of Compaq Information Technologies Group, L.P. in the United States and other countries.

Motif, OSF, OSF/1, OSF/Motif, and Open Software Foundation are registered trademarks of The Open Group.

All other product names mentioned herein may be trademarks of their respective companies.

Confidential computer software. Valid license from Compaq required for possession, use, or copying. Consistent with FAR 12.211 and 12.212, Commercial Computer Software, Computer Software Documentation, and Technical Data for Commercial Items are licensed to the U.S. Government under vendor's standard commercial license.

Compaq shall not be liable for technical or editorial errors or omissions contained herein. The information in this document is provided "as is" without warranty of any kind and is subject to change without notice. The warranties for Compaq products are set forth in the express limited warranty statements accompanying such products. Nothing herein should be construed as constituting an additional warranty.

ZK5935

The Compaq *OpenVMS* documentation set is available on CD-ROM.

This document was prepared using DECdocument, Version 3.3-1b.

Contents

| | |
|--|------|
| Preface | xi |
| Part I SMG\$ Tutorial Section | |
| 1 Overview of the Screen Management Facility (SMG\$) | |
| 1.1 Pasteboards | 1-4 |
| 1.2 Virtual Displays | 1-5 |
| 1.3 Viewports | 1-6 |
| 1.4 Virtual Keyboards | 1-7 |
| 2 Screen Management Output Operations | |
| 2.1 Composition Operations | 2-1 |
| 2.1.1 Paste Operation | 2-1 |
| 2.1.2 Unpaste Operation | 2-2 |
| 2.1.3 Repaste Operation | 2-3 |
| 2.1.4 Move Operation | 2-3 |
| 2.1.5 Delete and Pop Operations | 2-4 |
| 2.1.6 Occlusion Check Operation | 2-5 |
| 2.2 Output Through Virtual Displays | 2-5 |
| 2.2.1 Cursor Position | 2-6 |
| 2.2.2 Deletion Operations | 2-7 |
| 2.2.3 Erasure Operations | 2-8 |
| 2.2.4 Insertion Operations | 2-8 |
| 2.2.5 Writing Operations | 2-8 |
| 2.2.5.1 Character-Oriented Output | 2-8 |
| 2.2.5.2 Line-Oriented Output | 2-9 |
| 2.2.6 Changing the Rendition of a Virtual Display | 2-9 |
| 2.2.7 Drawing and Removing Drawn Lines and Characters | 2-11 |
| 2.2.8 Displaying External Text | 2-12 |
| 2.2.9 Reading from a Virtual Display | 2-12 |
| 2.2.10 Viewports | 2-12 |
| 2.2.10.1 Creating a Viewport | 2-12 |
| 2.2.10.2 Deleting a Viewport | 2-12 |
| 2.2.10.3 Pasting and Unpasting a Viewport | 2-13 |
| 2.2.10.4 Scrolling and Moving a Viewport | 2-13 |
| 2.2.10.5 Changing Viewport Characteristics | 2-13 |
| 2.2.11 Menus | 2-13 |
| 2.2.11.1 Creating a Menu | 2-14 |
| 2.2.11.2 Deleting a Menu | 2-14 |
| 2.2.11.3 Selecting from a Menu | 2-14 |
| 2.2.11.3.1 Default Mode | 2-14 |
| 2.2.11.3.2 RETURN_IMMED Mode | 2-14 |

| | | |
|------------|---|------|
| 2.2.11.3.3 | REMOVE_ITEM Mode | 2-15 |
| 2.2.12 | Saving a Virtual Display | 2-15 |
| 2.2.13 | Changing Terminal Characteristics | 2-15 |
| 2.2.14 | Hardcopy and File Output Operations | 2-15 |
| 2.2.14.1 | Snapshots | 2-15 |
| 2.2.14.2 | Printing a Pasteboard | 2-16 |
| 2.2.14.3 | Pasteboard Output by Means of a User-Supplied Routine | 2-16 |
| 2.3 | Operational Controls | 2-16 |
| 2.3.1 | Minimal Update | 2-16 |
| 2.3.2 | Buffering | 2-16 |
| 2.3.3 | Tabs | 2-16 |
| 2.4 | Batching Output Operations | 2-17 |
| 2.4.1 | Display Update Batching | 2-17 |
| 2.4.2 | Pasteboard Update Batching | 2-17 |

3 Screen Management Input Operations

| | | |
|-------|---|-----|
| 3.1 | Obtaining Data from Virtual Keyboards | 3-1 |
| 3.2 | Obtaining Data from a Mouse or Tablet | 3-2 |
| 3.3 | Setting and Retrieving Virtual Keyboard Characteristics | 3-2 |
| 3.4 | Line Composition Using Keypad Keys | 3-2 |
| 3.5 | States | 3-3 |
| 3.6 | Terminators | 3-3 |
| 3.6.1 | Single-Character Terminators | 3-4 |
| 3.6.2 | Character Sequence Terminators | 3-4 |
| 3.6.3 | Termination by a Condition | 3-6 |
| 3.6.4 | Key Name and Terminator Code Translation | 3-6 |
| 3.6.5 | Symbolic Definitions of Terminator Values | 3-7 |
| 3.7 | Line Recall and the Recall Buffer | 3-7 |
| 3.8 | Interaction of Input and Output | 3-7 |

4 Advanced Screen Management Features

| | | |
|-------|--|-----|
| 4.1 | Asynchronous Events | 4-1 |
| 4.1.1 | Broadcast Messages | 4-2 |
| 4.1.2 | Unsolicited Input | 4-2 |
| 4.1.3 | Out-of-Band ASTs | 4-2 |
| 4.2 | Subprocesses | 4-2 |
| 4.2.1 | Creating a Subprocess | 4-2 |
| 4.2.2 | Deleting a Subprocess | 4-2 |
| 4.2.3 | Executing Commands in a Subprocess | 4-3 |
| 4.3 | Moving the Cursor | 4-3 |
| 4.4 | Exit Handler | 4-3 |

5 Support for Third-Party Terminals

| | | |
|-------|--|------|
| 5.1 | TERMTABLE Interface Routines | 5-1 |
| 5.2 | Capability Fields | 5-3 |
| 5.2.1 | Boolean Capability Fields | 5-4 |
| 5.2.2 | Numeric Capability Fields | 5-5 |
| 5.2.3 | String Capability Fields | 5-6 |
| 5.2.4 | Argument Substitution | 5-14 |
| 5.2.5 | Arithmetic Operations | 5-15 |
| 5.3 | Creating an OpenVMS Terminal Capabilities File | 5-16 |

| | | |
|-----|---|------|
| 5.4 | Examples | 5-16 |
| 5.5 | Creating TERMTABLE.EXE | 5-20 |
| 5.6 | Capability Fields Used by Screen Management | 5-21 |
| 5.7 | Input Support for Foreign Terminals | 5-22 |
| 5.8 | Support for SET and SHOW TERMINAL Commands | 5-23 |

6 Using Screen Management Routines to Develop New Programs

| | | |
|-----|---|-----|
| 6.1 | Calling Screen Management Routines | 6-1 |
| 6.2 | Calling Routines That Do Not Use the Screen Management Facility | 6-3 |

7 Examples of Calling SMG\$ Routines

Part II SMG\$ Reference Section

| | |
|---------------------------------------|--------|
| SMG\$ADD_KEY_DEF | SMG-3 |
| SMG\$BEGIN_DISPLAY_UPDATE | SMG-6 |
| SMG\$BEGIN_PASTEBOARD_UPDATE | SMG-7 |
| SMG\$CANCEL_INPUT | SMG-8 |
| SMG\$CHANGE_PBD_CHARACTERISTICS | SMG-9 |
| SMG\$CHANGE_RENDITION | SMG-12 |
| SMG\$CHANGE_VIEWPORT | SMG-15 |
| SMG\$CHANGE_VIRTUAL_DISPLAY | SMG-21 |
| SMG\$CHECK_FOR_OCCLUSION | SMG-24 |
| SMG\$CONTROL_MODE | SMG-28 |
| SMG\$COPY_VIRTUAL_DISPLAY | SMG-32 |
| SMG\$CREATE_KEY_TABLE | SMG-38 |
| SMG\$CREATE_MENU | SMG-39 |
| SMG\$CREATE_PASTEBOARD | SMG-43 |
| SMG\$CREATE_SUBPROCESS | SMG-47 |
| SMG\$CREATE_VIEWPORT | SMG-52 |
| SMG\$CREATE_VIRTUAL_DISPLAY | SMG-56 |
| SMG\$CREATE_VIRTUAL_KEYBOARD | SMG-61 |
| SMG\$CURSOR_COLUMN | SMG-65 |
| SMG\$CURSOR_ROW | SMG-66 |
| SMG\$DEFINE_KEY | SMG-67 |
| SMG\$DELETE_CHARS | SMG-69 |
| SMG\$DELETE_KEY_DEF | SMG-74 |
| SMG\$DELETE_LINE | SMG-76 |
| SMG\$DELETE_MENU | SMG-80 |
| SMG\$DELETE_PASTEBOARD | SMG-81 |
| SMG\$DELETE_SUBPROCESS | SMG-83 |
| SMG\$DELETE_VIEWPORT | SMG-84 |
| SMG\$DELETE_VIRTUAL_DISPLAY | SMG-85 |
| SMG\$DELETE_VIRTUAL_KEYBOARD | SMG-86 |
| SMG\$DEL_TERM_TABLE | SMG-87 |
| SMG\$DISABLE_BROADCAST_TRAPPING | SMG-88 |
| SMG\$DISABLE_UNSOLICITED_INPUT | SMG-98 |

| | |
|----------------------------------|---------|
| SMG\$DRAW_CHAR | SMG-100 |
| SMG\$DRAW_LINE | SMG-104 |
| SMG\$DRAW_RECTANGLE | SMG-109 |
| SMG\$ENABLE_UNSOLICITED_INPUT | SMG-114 |
| SMG\$END_DISPLAY_UPDATE | SMG-117 |
| SMG\$END_PASTEBOARD_UPDATE | SMG-118 |
| SMG\$ERASE_CHARS | SMG-119 |
| SMG\$ERASE_COLUMN | SMG-123 |
| SMG\$ERASE_DISPLAY | SMG-125 |
| SMG\$ERASE_LINE | SMG-130 |
| SMG\$ERASE_PASTEBOARD | SMG-134 |
| SMG\$EXECUTE_COMMAND | SMG-136 |
| SMG\$FIND_CURSOR_DISPLAY | SMG-138 |
| SMG\$FLUSH_BUFFER | SMG-140 |
| SMG\$FLUSH_DISPLAY_UPDATE | SMG-141 |
| SMG\$GET_BROADCAST_MESSAGE | SMG-142 |
| SMG\$GET_CHAR_AT_PHYSICAL_CURSOR | SMG-144 |
| SMG\$GET_DISPLAY_ATTR | SMG-146 |
| SMG\$GET_KEYBOARD_ATTRIBUTES | SMG-149 |
| SMG\$GET_KEY_DEF | SMG-152 |
| SMG\$GET_NUMERIC_DATA | SMG-155 |
| SMG\$GET_PASTEBOARD_ATTRIBUTES | SMG-157 |
| SMG\$GET_PASTING_INFO | SMG-160 |
| SMG\$GET_TERM_DATA | SMG-162 |
| SMG\$GET_VIEWPORT_CHAR | SMG-164 |
| SMG\$HOME_CURSOR | SMG-168 |
| SMG\$INIT_TERM_TABLE | SMG-170 |
| SMG\$INIT_TERM_TABLE_BY_TYPE | SMG-172 |
| SMG\$INSERT_CHARS | SMG-174 |
| SMG\$INSERT_LINE | SMG-180 |
| SMG\$INVALIDATE_DISPLAY | SMG-186 |
| SMG\$KEYCODE_TO_NAME | SMG-187 |
| SMG\$LABEL_BORDER | SMG-189 |
| SMG\$LIST_KEY_DEFS | SMG-195 |
| SMG\$LIST_PASTEBOARD_ORDER | SMG-198 |
| SMG\$LIST_PASTING_ORDER | SMG-200 |
| SMG\$LOAD_KEY_DEFS | SMG-202 |
| SMG\$LOAD_VIRTUAL_DISPLAY | SMG-204 |
| SMG\$MOVE_TEXT | SMG-206 |
| SMG\$MOVE_VIRTUAL_DISPLAY | SMG-209 |
| SMG\$NAME_TO_KEYCODE | SMG-212 |
| SMG\$PASTE_VIRTUAL_DISPLAY | SMG-214 |
| SMG\$POP_VIRTUAL_DISPLAY | SMG-216 |
| SMG\$PRINT_PASTEBOARD | SMG-218 |
| SMG\$PUT_CHARS | SMG-220 |
| SMG\$PUT_CHARS_HIGHWIDE | SMG-225 |
| SMG\$PUT_CHARS_MULTI | SMG-228 |

| | |
|--------------------------------|---------|
| SMG\$PUT_CHARS_WIDE | SMG-231 |
| SMG\$PUT_HELP_TEXT | SMG-234 |
| SMG\$PUT_LINE | SMG-237 |
| SMG\$PUT_LINE_HIGHWIDE | SMG-243 |
| SMG\$PUT_LINE_MULTI | SMG-246 |
| SMG\$PUT_LINE_WIDE | SMG-251 |
| SMG\$PUT_PASTEBOARD | SMG-256 |
| SMG\$PUT_STATUS_LINE | SMG-258 |
| SMG\$READ_COMPOSED_LINE | SMG-260 |
| SMG\$READ_FROM_DISPLAY | SMG-265 |
| SMG\$READ_KEYSTROKE | SMG-270 |
| SMG\$READ_LOCATOR | SMG-278 |
| SMG\$READ_STRING | SMG-282 |
| SMG\$READ_VERIFY | SMG-293 |
| SMG\$REMOVE_LINE | SMG-300 |
| SMG\$REPAINT_LINE | SMG-302 |
| SMG\$REPAINT_SCREEN | SMG-304 |
| SMG\$REPASTE_VIRTUAL_DISPLAY | SMG-308 |
| SMG\$REPLACE_INPUT_LINE | SMG-314 |
| SMG\$RESTORE_PHYSICAL_SCREEN | SMG-317 |
| SMG\$RETURN_CURSOR_POS | SMG-319 |
| SMG\$RETURN_INPUT_LINE | SMG-321 |
| SMG\$RING_BELL | SMG-324 |
| SMG\$SAVE_PHYSICAL_SCREEN | SMG-325 |
| SMG\$SAVE_VIRTUAL_DISPLAY | SMG-327 |
| SMG\$SCROLL_DISPLAY_AREA | SMG-329 |
| SMG\$SCROLL_VIEWPORT | SMG-332 |
| SMG\$SELECT_FROM_MENU | SMG-339 |
| SMG\$SET_BROADCAST_TRAPPING | SMG-355 |
| SMG\$SET_CURSOR_ABS | SMG-357 |
| SMG\$SET_CURSOR_MODE | SMG-359 |
| SMG\$SET_CURSOR_REL | SMG-361 |
| SMG\$SET_DEFAULT_STATE | SMG-363 |
| SMG\$SET_DISPLAY_SCROLL_REGION | SMG-365 |
| SMG\$SET_KEYPAD_MODE | SMG-367 |
| SMG\$SET_OUT_OF_BAND_ASTS | SMG-369 |
| SMG\$SET_PHYSICAL_CURSOR | SMG-373 |
| SMG\$SET_TERM_CHARACTERISTICS | SMG-375 |
| SMG\$SNAPSHOT | SMG-379 |
| SMG\$SNAPSHOT_TO_PRINTER | SMG-381 |
| SMG\$UNPASTE_VIRTUAL_DISPLAY | SMG-383 |

Index

Examples

| | | |
|-----|---|------|
| 7-1 | Using SMG\$ Routines in Compaq Ada | 7-1 |
| 7-2 | Using SMG\$ Routines in Compaq BASIC | 7-4 |
| 7-3 | Using SMG\$ Routines in VAX BLISS-32 | 7-6 |
| 7-4 | Using SMG\$ Routines in Compaq COBOL | 7-9 |
| 7-5 | Using SMG\$ Routines in Compaq Fortran..... | 7-10 |
| 7-6 | Using SMG\$ Routines in VAX MACRO | 7-12 |
| 7-7 | Using SMG\$ Routines in Compaq Pascal..... | 7-14 |
| 7-8 | Using SMG\$ Routines in VAX PL/I | 7-16 |

Figures

| | | |
|--------|--|---------|
| 1-1 | Pasteboard Coordinate System..... | 1-5 |
| 2-1 | Paste Operation | 2-2 |
| 2-2 | Unpaste Operation..... | 2-2 |
| 2-3 | Repaste Operation | 2-3 |
| 2-4 | Move Operation | 2-4 |
| 2-5 | Pop Operation | 2-5 |
| 2-6 | Occlusion Check..... | 2-6 |
| 2-7 | Lines Drawn Without SMG\$DRAW_LINE | 2-11 |
| 2-8 | Lines Drawn With SMG\$DRAW_LINE | 2-11 |
| SMG-1 | Output Generated After Virtual Displays Are Pasted | SMG-18 |
| SMG-2 | Output Generated After the Viewport Is Created | SMG-19 |
| SMG-3 | Output Generated After Calling SMG\$CHANGE_VIEWPORT | SMG-20 |
| SMG-4 | Output Generated by Fortran Program Calling SMG\$CHECK_FOR_OCCLUSION..... | SMG-27 |
| SMG-5 | First Virtual Display Generated by SMG\$COPY_VIRTUAL_DISPLAY | SMG-35 |
| SMG-6 | Second Virtual Display Generated by SMG\$COPY_VIRTUAL_DISPLAY | SMG-36 |
| SMG-7 | Output Generated After the Call to SMG\$COPY_VIRTUAL_DISPLAY | SMG-37 |
| SMG-8 | Output Generated by Creating a Viewport..... | SMG-55 |
| SMG-9 | Output of Fortran Program Calling SMG\$CREATE_VIRTUAL_DISPLAY..... | SMG-60 |
| SMG-10 | Output Generated Before the Call to SMG\$DELETE_CHARS | SMG-72 |
| SMG-11 | Output Generated After the Call to SMG\$DELETE_CHARS | SMG-73 |
| SMG-12 | Output Generated by Fortran Program Before the Call to SMG\$DELETE_LINE | SMG-78 |
| SMG-13 | Output Generated After the Call to SMG\$DELETE_LINE | SMG-79 |
| SMG-14 | Output Generated Before Any Input or Messages Are Trapped | SMG-95 |
| SMG-15 | Output Generated After a Broadcast Message Is Trapped | SMG-96 |
| SMG-16 | Output Generated After a Call to LIB\$SPAWN | SMG-97 |
| SMG-17 | Output Generated by Fortran Program Calling SMG\$DRAW_LINE | SMG-108 |

| | | |
|--------|---|---------|
| SMG-18 | Output Generated by Fortran Program Calling SMG\$DRAW_RECTANGLE | SMG-113 |
| SMG-19 | AST Routine Arguments | SMG-115 |
| SMG-20 | Output Before the Call to SMG\$ERASE_CHARS | SMG-121 |
| SMG-21 | Output After the Call to SMG\$ERASE_CHARS | SMG-122 |
| SMG-22 | Initial Output of Fortran Program Calling SMG\$ERASE_DISPLAY | SMG-128 |
| SMG-23 | Output Displayed After the Call to SMG\$ERASE_DISPLAY | SMG-129 |
| SMG-24 | Initial Output Generated by Fortran Program Calling SMG\$ERASE_LINE | SMG-132 |
| SMG-25 | Output Generated After the Call to SMG\$ERASE_LINE | SMG-133 |
| SMG-26 | Output Generated by SMG\$GET_VIEWPORT_CHAR | SMG-167 |
| SMG-27 | Output Generated by Fortran Program Before the Call to SMG\$INSERT_CHARS | SMG-178 |
| SMG-28 | Output Generated by Fortran Program After the Call to SMG\$INSERT_CHARS | SMG-179 |
| SMG-29 | Output Generated Before the Call to SMG\$INSERT_LINE | SMG-184 |
| SMG-30 | Output Generated After the Call to SMG\$INSERT_LINE | SMG-185 |
| SMG-31 | Output Generated by Program Calling SMG\$LABEL_BORDER | SMG-194 |
| SMG-32 | Arguments for Moving Text | SMG-208 |
| SMG-33 | Output of Fortran Program Calling SMG\$PUT_CHARS | SMG-224 |
| SMG-34 | Output Generated by Fortran Program Calling SMG\$PUT_LINE | SMG-241 |
| SMG-35 | Output Generated by Fortran Program Calling SMG\$PUT_LINE_WIDE | SMG-255 |
| SMG-36 | Output Generated by Fortran Program Calling SMG\$READ_FROM_DISPLAY | SMG-269 |
| SMG-37 | Output Generated by Fortran Program Calling SMG\$READ_KEYSTROKE | SMG-275 |
| SMG-38 | Output Generated Before the Call to SMG\$READ_STRING | SMG-291 |
| SMG-39 | Output Generated After the Call to SMG\$READ_STRING | SMG-292 |
| SMG-40 | Output Generated by Fortran Program Calling SMG\$REPAINT_SCREEN | SMG-306 |
| SMG-41 | Output Generated by Fortran Program Calling SMG\$REPAINT_SCREEN | SMG-307 |
| SMG-42 | Output Before the Call to SMG\$MOVE_VIRTUAL_DISPLAY | SMG-311 |
| SMG-43 | Output Displayed After the Call to SMG\$MOVE_VIRTUAL_DISPLAY | SMG-312 |
| SMG-44 | Output Displayed After the Call to SMG\$REPASTE_VIRTUAL_DISPLAY | SMG-313 |
| SMG-45 | Output Generated by Pasting the Virtual Display | SMG-335 |
| SMG-46 | Output Generated After First Call to SMG\$SCROLL_VIEWPORT | SMG-336 |
| SMG-47 | Output Generated After the Second Call to SMG\$SCROLL_VIEWPORT | SMG-337 |
| SMG-48 | Output Generated After the Last Call to SMG\$SCROLL_VIEWPORT | SMG-338 |
| SMG-49 | Output Generated Before a Menu Selection Is Made | SMG-346 |
| SMG-50 | Output Generated After the User Selects an Item | SMG-347 |
| SMG-51 | Output Generated Before the User Selects a Menu Item | SMG-349 |
| SMG-52 | Output Generated After Two Selections | SMG-350 |

| | | |
|--------|---|---------|
| SMG-53 | Output Generated After EXIT Is Selected | SMG-351 |
| SMG-54 | Output Generated Before a Menu Item Is Selected | SMG-352 |
| SMG-55 | Output Generated After Three Menu Selections | SMG-353 |
| SMG-56 | Output Generated After Program Completion | SMG-354 |

Tables

| | | |
|-----|---|------|
| 1-1 | Routines That Support Third-Party Terminals | 1-1 |
| 1-2 | Input Routines | 1-2 |
| 1-3 | Output Routines | 1-2 |
| 3-1 | Terminator Values | 3-5 |
| 5-1 | Boolean Capabilities | 5-4 |
| 5-2 | Numeric Capabilities | 5-5 |
| 5-3 | String Capabilities | 5-7 |
| 5-4 | String_2 Capabilities | 5-12 |

Preface

This manual provides users of the OpenVMS operating system with detailed usage and reference information on screen management routines supplied in the SMG\$ facility of the OpenVMS Run-Time Library (RTL).

Intended Audience

This manual is intended for system and application programmers who write programs that call SMG\$ Run-Time Library routines.

Document Structure

This manual is organized into two parts as follows:

- The first part of the book contains introductory chapters that provide guidelines and reference material on specific types of screen management routines. The material covered is as follows:
 - Chapter 1 lists the SMG\$ routines and provides a brief overview of the major SMG\$ components.
 - Chapter 2 discusses output operations provided by the Screen Management Facility.
 - Chapter 3 describes screen management routines used to enter input from a virtual keyboard.
 - Chapter 4 discusses the Screen Management Facility's advanced features.
 - Chapter 5 discusses a method of supporting foreign terminals.
 - Chapter 6 discusses some recommended methods for using the Screen Management Facility for developing new programs.
 - Chapter 7 contains examples demonstrating how to call some SMG\$ routines from major OpenVMS languages.
- The SMG\$ Reference Section (Part II) provides detailed reference information on each routine in the SMG\$ facility of the Run-Time Library. This information uses the documentation format described in *OpenVMS Programming Concepts Manual*. Routine descriptions appear in alphabetical order by routine name.

Related Documents

The Run-Time Library routines are documented in a series of reference manuals. A description of how you access the Run-Time Library routines and of OpenVMS features and functionality available through calls to the SMG\$ Run-Time Library appears in the *OpenVMS Programming Concepts Manual*. Descriptions of other RTL facilities and their corresponding routines and usages are discussed in the following books:

- *Compaq Portable Mathematics Library*
- *OpenVMS RTL DECTalk (DTK\$) Manual*¹
- *OpenVMS RTL Library (LIB\$) Manual*
- *OpenVMS VAX RTL Mathematics (MTH\$) Manual*
- *OpenVMS RTL General Purpose (OTSS\$) Manual*
- *OpenVMS RTL Parallel Processing (PPL\$) Manual*¹
- *OpenVMS RTL String Manipulation (STR\$) Manual*

The *Guide to the POSIX Threads Library* contains guidelines and reference information for Compaq POSIX Threads², the Compaq Multithreading Run-Time Library.

The *OpenVMS Command Definition, Librarian, and Message Utilities Manual* provides information useful for writing applications that use line composition with keypad keys.

The *OpenVMS I/O User's Reference Manual* contains information about using mailboxes.

Application programmers using any programming language can refer to the *Guide to Creating OpenVMS Modular Procedures* for writing modular and reentrant code.

High-level language programmers will find additional information on calling Run-Time Library routines in their language reference manual. You can also find additional information in the language user's guide provided with your OpenVMS language software.

For a complete list and description of the manuals in the OpenVMS documentation set, see the *OpenVMS Version 7.3 New Features and Documentation Overview Manual*.

For additional information about OpenVMS products and services, access the Compaq website at the following location:

<http://www.openvms.compaq.com/>

¹ This manual has been archived but is available on the OpenVMS Documentation CD-ROM.

² Compaq POSIX Threads was formerly called DECthreads.

Reader's Comments

Compaq welcomes your comments on this manual. Please send comments to either of the following addresses:

| | |
|----------|--|
| Internet | openvmsdoc@compaq.com |
| Mail | Compaq Computer Corporation OSSG Documentation Group, ZKO3-4/U08 110 Spit Brook Rd. Nashua, NH 03062-2698 |

How To Order Additional Documentation

Use the following World Wide Web address to order additional documentation:

<http://www.openvms.compaq.com/>

If you need help deciding which documentation best meets your needs, call 800-282-6672.

Conventions

The following conventions are used in this manual:

| | |
|--|--|
| Ctrl/ <i>x</i> | A sequence such as Ctrl/ <i>x</i> indicates that you must hold down the key labeled Ctrl while you press another key or a pointing device button. |
| PF1 <i>x</i> | A sequence such as PF1 <i>x x</i> indicates that you must first press and release the key labeled PF1 and then press and release another key or a pointing device button. |
| Return | In examples, a key name enclosed in a box indicates that you press a key on the keyboard. (In text, a key name is not enclosed in a box.) In the HTML version of this document, this convention appears as brackets, rather than a box. |
| ... | A horizontal ellipsis in examples indicates one of the following possibilities: <ul style="list-style-type: none">• Additional optional arguments in a statement have been omitted.• The preceding item or items can be repeated one or more times.• Additional parameters, values, or other information can be entered. |
| . | A vertical ellipsis indicates the omission of items from a code example or command format; the items are omitted because they are not important to the topic being discussed. |
| () | In command format descriptions, parentheses indicate that you must enclose choices in parentheses if you specify more than one. |
| [] | In command format descriptions, brackets indicate optional choices. You can choose one or more items or no items. Do not type the brackets on the command line. However, you must include the brackets in the syntax for OpenVMS directory specifications and for a substring specification in an assignment statement. |

| | |
|--------------------|--|
| { } | In command format descriptions, braces indicate required choices; you must choose at least one of the items listed. Do not type the braces on the command line. |
| bold text | This typeface represents the introduction of a new term. It also represents the name of an argument, an attribute, or a reason. |
| <i>italic text</i> | Italic text indicates important information, complete titles of manuals, or variables. Variables include information that varies in system output (Internal error <i>number</i>), in command lines (<i>PRÓDUCER=name</i>), and in command parameters in text (where <i>dd</i> represents the predefined code for the device type). |
| UPPERCASE TEXT | Uppercase text indicates a command, the name of a routine, the name of a file, or the abbreviation for a system privilege. |
| Monospace text | Monospace type indicates code examples and interactive screen displays. In the C programming language, monospace type in text identifies the following elements: keywords, the names of independently compiled external functions and files, syntax summaries, and references to variables or identifiers introduced in an example. |
| - | A hyphen at the end of a command format description, command line, or code line indicates that the command or statement continues on the following line. |
| numbers | All numbers in text are assumed to be decimal unless otherwise noted. Nondecimal radices—binary, octal, or hexadecimal—are explicitly indicated. |

Part I

SMG\$ Tutorial Section

This part of the *OpenVMS RTL Screen Management (SMG\$) Manual* contains introductory chapters that provide guidelines and reference material on specific types of screen management routines. The material covered is as follows:

- Chapter 1 lists the SMG\$ routines and provides a brief overview of the major SMG\$ components.
- Chapter 2 discusses output operations provided by the Screen Management Facility.
- Chapter 3 describes screen management routines used to enter input from a virtual keyboard.
- Chapter 4 discusses the Screen Management Facility's advanced features.
- Chapter 5 discusses a method of supporting foreign terminals.
- Chapter 6 discusses some recommended methods for using the Screen Management Facility for developing new programs.
- Chapter 7 contains examples demonstrating how to call some SMG\$ routines from major OpenVMS languages.

Overview of the Screen Management Facility (SMG\$)

This manual discusses the Run-Time Library routines that perform terminal-independent functions. The most important aspect of the Screen Management Facility is that user programs are entirely separate from the physical devices that actually perform input and output. Instead of writing directly to a physical screen, the user program writes to a **virtual display**. Similarly, instead of entering input directly from a physical keyboard, user programs enter input from a **virtual keyboard**. (Virtual displays and virtual keyboards are logical entities whose usage is described more fully in the following sections.) This separation of virtual operations from physical operations is what allows input/output to be terminal independent.

The SMG\$ routines listed below help you design, compose, and keep track of complex images on a video screen. These routines are meant for the types of operations you would normally perform on a VT100-class terminal; they also provide software emulation of screen management functions on terminals that do not have these functions implemented in their hardware. While you can use these routines with video terminals, you can also use them with hardcopy devices and files. The following lists contain all the screen management routines grouped according to their functions.

Table 1–1 lists routines that support third-party terminals; Chapter 5 discusses these routines.

Table 1–2 lists the SMG\$ input routines; Chapter 3 discusses these routines.

Table 1–3 lists the SMG\$ output routines; Chapter 2 discusses these routines.

Table 1–1 Routines That Support Third-Party Terminals

| | |
|------------------------------|-----------------------|
| SMG\$DEL_TERM_TABLE | SMG\$GET_NUMERIC_DATA |
| SMG\$GET_TERM_DATA | SMG\$INIT_TERM_TABLE |
| SMG\$INIT_TERM_TABLE_BY_TYPE | |

Overview of the Screen Management Facility (SMG\$)

Table 1–2 Input Routines

| | |
|------------------------------|------------------------------|
| SMG\$ADD_KEY_DEF | SMG\$CANCEL_INPUT |
| SMG\$CREATE_KEY_TABLE | SMG\$CREATE_VIRTUAL_KEYBOARD |
| SMG\$DEFINE_KEY | SMG\$DELETE_KEY_DEF |
| SMG\$DELETE_VIRTUAL_KEYBOARD | SMG\$GET_KEY_DEF |
| SMG\$GET_KEYBOARD_ATTRIBUTES | SMG\$KEYCODE_TO_NAME |
| SMG\$LIST_KEY_DEFS | SMG\$LOAD_KEY_DEFS |
| SMG\$NAME_TO_KEYCODE | SMG\$READ_COMPOSED_LINE |
| SMG\$READ_KEYSTROKE | SMG\$READ_LOCATOR |
| SMG\$READ_STRING | SMG\$READ_VERIFY |
| SMG\$REPLACE_INPUT_LINE | SMG\$RETURN_INPUT_LINE |
| SMG\$SET_DEFAULT_STATE | SMG\$SET_KEYPAD_MODE |

Table 1–3 Output Routines

| | |
|---------------------------------|----------------------------------|
| SMG\$BEGIN_DISPLAY_UPDATE | SMG\$BEGIN_PASTEBOARD_UPDATE |
| SMG\$CHANGE_PBD_CHARACTERISTICS | SMG\$CHANGE_RENDITION |
| SMG\$CHANGE_VIEWPORT | SMG\$CHANGE_VIRTUAL_DISPLAY |
| SMG\$CHECK_FOR_OCCLUSION | SMG\$CONTROL_MODE |
| SMG\$COPY_VIRTUAL_DISPLAY | SMG\$CREATE_MENU |
| SMG\$CREATE_PASTEBOARD | SMG\$CREATE_SUBPROCESS |
| SMG\$CREATE_VIEWPORT | SMG\$CREATE_VIRTUAL_DISPLAY |
| SMG\$CURSOR_COLUMN | SMG\$CURSOR_ROW |
| SMG\$DELETE_CHARS | SMG\$DELETE_LINE |
| SMG\$DELETE_MENU | SMG\$DELETE_PASTEBOARD |
| SMG\$DELETE_SUBPROCESS | SMG\$DELETE_VIEWPORT |
| SMG\$DELETE_VIRTUAL_DISPLAY | SMG\$DISABLE_BROADCAST_TRAPPING |
| SMG\$DISABLE_UNSOLICITED_INPUT | SMG\$DRAW_CHAR |
| SMG\$DRAW_LINE | SMG\$DRAW_RECTANGLE |
| SMG\$ENABLE_UNSOLICITED_INPUT | SMG\$END_DISPLAY_UPDATE |
| SMG\$END_PASTEBOARD_UPDATE | SMG\$ERASE_CHARS |
| SMG\$ERASE_COLUMN | SMG\$ERASE_DISPLAY |
| SMG\$ERASE_LINE | SMG\$ERASE_PASTEBOARD |
| SMG\$EXECUTE_COMMAND | SMG\$FIND_CURSOR_DISPLAY |
| SMG\$FLUSH_BUFFER | SMG\$FLUSH_DISPLAY_UPDATE |
| SMG\$GET_BROADCAST_MESSAGE | SMG\$GET_CHAR_AT_PHYSICAL_CURSOR |
| SMG\$GET_DISPLAY_ATTR | SMG\$GET_PASTEBOARD_ATTRIBUTES |
| SMG\$GET_PASTING_INFO | SMG\$GET_VIEWPORT_CHAR |

(continued on next page)

Overview of the Screen Management Facility (SMG\$)

Table 1–3 (Cont.) Output Routines

| | |
|-------------------------------|--------------------------------|
| SMG\$HOME_CURSOR | SMG\$INSERT_CHARS |
| SMG\$INSERT_LINE | SMG\$INVALIDATE_DISPLAY |
| SMG\$LABEL_BORDER | SMG\$LIST_PASTEBOARD_ORDER |
| SMG\$LIST_PASTING_ORDER | SMG\$LOAD_VIRTUAL_DISPLAY |
| SMG\$MOVE_TEXT | SMG\$MOVE_VIRTUAL_DISPLAY |
| SMG\$PASTE_VIRTUAL_DISPLAY | SMG\$POP_VIRTUAL_DISPLAY |
| SMG\$PRINT_PASTEBOARD | SMG\$PUT_CHARS |
| SMG\$PUT_CHARS_HIGHWIDE | SMG\$PUT_CHARS_MULTI |
| SMG\$PUT_CHARS_WIDE | SMG\$PUT_HELP_TEXT |
| SMG\$PUT_LINE | SMG\$PUT_LINE_HIGHWIDE |
| SMG\$PUT_LINE_MULTI | SMG\$PUT_LINE_WIDE |
| SMG\$PUT_PASTEBOARD | SMG\$PUT_STATUS_LINE |
| SMG\$READ_FROM_DISPLAY | SMG\$REMOVE_LINE |
| SMG\$REPAINT_LINE | SMG\$REPAINT_SCREEN |
| SMG\$REPASTE_VIRTUAL_DISPLAY | SMG\$RESTORE_PHYSICAL_SCREEN |
| SMG\$RETURN_CURSOR_POS | SMG\$RING_BELL |
| SMG\$SAVE_PHYSICAL_SCREEN | SMG\$SAVE_VIRTUAL_DISPLAY |
| SMG\$SCROLL_DISPLAY_AREA | SMG\$SCROLL_VIEWPORT |
| SMG\$SELECT_FROM_MENU | SMG\$SET_BROADCAST_TRAPPING |
| SMG\$SET_CURSOR_ABS | SMG\$SET_CURSOR_MODE |
| SMG\$SET_CURSOR_REL | SMG\$SET_DISPLAY_SCROLL_REGION |
| SMG\$SET_OUT_OF_BAND_ASTS | SMG\$SET_PHYSICAL_CURSOR |
| SMG\$SET_TERM_CHARACTERISTICS | SMG\$SNAPSHOT |
| SMG\$SNAPSHOT_TO_PRINTER | SMG\$UNPASTE_VIRTUAL_DISPLAY |

The Screen Management Facility provides two important services:

- Terminal independence

The screen management routines provide terminal independence by allowing you to perform commonly needed screen functions regardless of terminal type. All operations, including input and output, are performed by calling a routine that converts the caller's terminal-independent request (for example, to scroll a part of the screen) into the sequence of codes needed to perform that action. If the terminal being used does not support the requested operation in hardware, in most cases the screen management routines accomplish the action by emulating it in software. Similarly, the screen management routines provide a terminal-independent means for performing input from a keyboard without concern for the type of keyboard.

Overview of the Screen Management Facility (SMG\$)

Note

The Screen Management Facility assumes that it has complete control of the terminal. Applications should not mix calls to SMG\$ with calls to other screen products such as Compaq GKS or Compaq FMS.

- Ease of composition

The screen management routines help you compose complex images on a screen. For example, you may want to solicit user input from one part of the screen, display results on a second part of the screen, and maintain a status display in a third part of the screen. Normally, each routine that reads from or writes to one of these regions must be aware that other regions exist and know where on the screen they are positioned, in order to properly bias its row and column references to locate the display on the desired part of the screen. Using the screen management routines, a routine can independently write to its dedicated region of the screen regardless of the position of the region. References to row and column pertain only to the region of the screen the routine is addressing.

The following sections discuss the fundamental elements of screen management. These elements are the pasteboard, the virtual display, the viewport, and the virtual keyboard.

1.1 Pasteboards

A pasteboard is a logical structure for performing output operations to a terminal screen. You can think of a pasteboard as a two-dimensional area on which you place and manipulate screen displays. A pasteboard is always associated with a physical device or an OpenVMS RMS file, but a pasteboard may be larger or smaller than the physical screen. Each output device has only one pasteboard.

Create a pasteboard by calling the `SMG$CREATE_PASTEBOARD` routine. Specify the physical device to be associated with the pasteboard as an argument. `SMG$CREATE_PASTEBOARD` returns a unique pasteboard identifier (**pasteboard-id**), which is used in subsequent routine calls where a pasteboard identifier is needed. For example, use the **pasteboard-id** to specify the physical terminal screen on which to paste a virtual display. `SMG$CREATE_PASTEBOARD` also returns the numbers of rows and columns available on the associated device as output arguments. You can use this information to create a virtual display the size of the physical screen. (Virtual displays are discussed in the next section.)

Think of a pasteboard as a logical coordinate system in which the relative orientation of one or more virtual displays is specified. (The pasteboard itself has no physical boundaries, but the physical screen does.) Figure 1-1 depicts the pasteboard coordinate system.

The origin (cellular position 1,1) corresponds to the upper left-hand corner of the physical screen. The numbering of rows and columns starts from this origin. For example, on a VT200 series terminal, with 24 rows and 80 columns, the first 24 rows and first 80 columns of the pasteboard coordinate system map to the physical screen. Note that you can place a virtual display anywhere in this coordinate system, not only in the quadrant that corresponds to the

Figure 1–1 Pasteboard Coordinate System

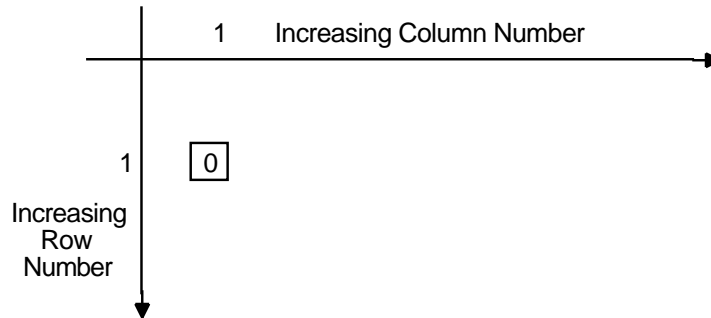

ZK-1910-GE

physical screen. Thus a virtual display, when pasted (that is, positioned on the pasteboard), may be invisible or only partly visible on the physical screen.

Pasteboards are deleted, or disassociated, from a particular device by the `SMG$DELETE_PASTEBOARD` routine. When a pasteboard is deleted, all virtual displays pasted to it are unpasted.

Once a pasteboard has been created, you can learn about its attributes (particularly its dimensions) by calling `SMG$GET_PASTEBOARD_ATTRIBUTES`. You can change the characteristics of a pasteboard by calling `SMG$CHANGE_PBD_CHARACTERISTICS` if the associated physical device allows the change. For example, if the device is a VT100, you can change the width of the pasteboard from 80 columns to 132 columns.

When the pasteboard is created, the Screen Management Facility clears the screen by default; however, you can request that the screen be left as it is. In addition, you can call `SMG$ERASE_PASTEBOARD` to erase the screen. You can also call `SMG$PRINT_PASTEBOARD` to print the contents of the pasteboard on a line printer.

1.2 Virtual Displays

A virtual display is a rectangular part of the terminal screen to which a program writes data using routine calls. Virtual displays are the main focus of the Screen Management Facility. When you create images to be placed on the screen, think in terms of virtual displays rather than in terms of the physical screen. This logical separation of the virtual display from the physical screen allows a main program to reposition virtual displays, so that a subroutine that writes to the virtual display need not be involved with positioning the display on the physical screen.

When you associate a virtual display with a pasteboard, it is **pasted**. When you remove the display from the pasteboard, it is **unpasted**. A virtual display is not displayed unless it is pasted to a pasteboard. (See Section 2.1.1 for more information on pasting virtual displays.)

The number of virtual displays that a program can create and maintain is limited only by the virtual address space available. A single virtual display can be pasted to more than one pasteboard at a time; thus, a program maintains only the virtual display. Any change to a virtual display is automatically reflected in each pasteboard to which the display is pasted (and its associated terminal screen).

Overview of the Screen Management Facility (SMG\$)

1.2 Virtual Displays

Create a virtual display by calling the `SMG$CREATE_VIRTUAL_DISPLAY` routine. The call must specify the number of rows and columns that make up the virtual display. The program can also request certain display and video attributes to be applied to the display.

`SMG$CREATE_VIRTUAL_DISPLAY` returns a unique virtual display identifier (**display-id**). This **display-id** identifies the virtual display in subsequent routine calls that modify the display.

A program or subroutine can determine which attributes and dimensions are associated with a virtual display by calling the `SMG$GET_DISPLAY_ATTR` routine. If you have multiple virtual displays pasted to a pasteboard, you can use `SMG$LIST_PASTING_ORDER` to determine the order in which the virtual displays are pasted.

If you do not specify video attributes, SMG applies default video characteristics to output. **Renditions** are video characteristics that you can turn on or off; they include bolding, blinking, reverse video, and underlined text. Display attributes are the characteristics that specify whether or not the display:

- Is bordered (the border may be labeled).
- Echoes carriage control characters (like form feed, vertical tab, and so on).
- Shows the user a diamond-shaped icon when text extends past the rightmost position in the display.

You can change the video and display attributes you specify when you create a virtual display. The `SMG$CHANGE_RENDITION` routine lets you change video attributes while the `SMG$CHANGE_VIRTUAL_DISPLAY` routine lets you change both video and display attributes. For example, you can redimension a virtual display with the latter routine. When you redimension a virtual display, the data in it is copied to the redimensioned display; that is, as much of the current contents (starting with row 1, column 1) as will fit in the newly dimensioned display are preserved.

You can delete a virtual display by calling the `SMG$DELETE_VIRTUAL_DISPLAY` routine. See Section 2.1.5 for more information on the delete operation.

1.3 Viewports

Since a virtual display can be very large, it is not always possible to show the entire display on the screen at one time. You must repaste a large virtual display to view a different portion of it. A viewport associated with the virtual display makes this job easier.

Viewporting refers to the process of moving a rectangular viewing area around on a virtual display to view different pieces of the virtual display. The viewport is associated with the virtual display so that any output operation that you perform on the virtual display is reflected on the viewport. You can create, delete, paste, unpaste, scroll, and move a viewport. See Section 2.2.10 for more information on viewports.

1.4 Virtual Keyboards

A virtual keyboard is a logical structure for input operations, just as a pasteboard is a logical structure for output operations. The advantage of using virtual keyboards is device independence. When using the screen management input routines, you need not worry about the terminal type. For example, your program need not know which line terminators a particular terminal uses; the screen management routines map the different terminator character sequences into a uniform set of function codes. (See Section 3.6 for more information about terminator codes.)

A virtual keyboard is usually associated with a physical keyboard on a terminal, but it may also be any file accessible through OpenVMS RMS. There is a many-to-one correspondence between virtual keyboards and an input device or file.

Establish a source for input (a virtual keyboard) by calling the `SMG$CREATE_VIRTUAL_KEYBOARD` routine. Delete virtual keyboards by calling the `SMG$DELETE_VIRTUAL_KEYBOARD` routine. Once you have created a virtual keyboard, you can obtain data from it with the `SMG$READ_COMPOSED_LINE`, `SMG$READ_KEYSTROKE`, `SMG$READ_STRING`, or `SMG$READ_VERIFY` routine. `SMG$READ_COMPOSED_LINE` reads a line composed of ordinary keystrokes and predefined strings associated with keypad and control keys; it provides an easy way to code an interface for command-oriented utilities by providing single-key command capabilities. Use the `SMG$READ_KEYSTROKE` routine to read one keystroke entered at the keyboard. `SMG$READ_STRING` reads a string composed of characters and a terminator; this routine is general purpose and flexible, providing access to many features of the OpenVMS terminal driver. Use the `SMG$READ_VERIFY` routine to read formatted input. You can abort all types of read operations by calling the `SMG$CANCEL_INPUT` routine.

Screen Management Output Operations

This chapter discusses the output operations provided by the Screen Management Facility. These output operations are described in terms of composition operations (operations that, in effect, create an image on a terminal screen) and output operations through virtual displays.

2.1 Composition Operations

Composition operations are the routines you use to manipulate virtual displays on a pasteboard and thus to create an image on a terminal screen. These operations include pasting, unpasting, repasting, moving and popping virtual displays, checking virtual displays for occlusion, and listing the pasting order.

2.1.1 Paste Operation

Virtual displays are visible on a physical device only while they are pasted to a pasteboard. Paste a display to a pasteboard by calling `SMG$PASTE_VIRTUAL_DISPLAY` and specifying the pasteboard coordinates as the origin of the virtual display. (The origin is the top left-hand corner.) The pasteboard itself has no boundaries, but of course the physical screen does. Thus you can paste a display to a pasteboard in such a way that some or all of the display does not appear on the terminal screen.

Pasting virtual displays to a pasteboard is a logical operation that maps the contents of a virtual display to a location on the screen by specifying the row and column of the pasteboard that coincide with row 1 and column 1 of the virtual display. For example, pasting a 6-row virtual display “A” to pasteboard rows 1 through 6 and pasting a second 6-row virtual display “B” to pasteboard rows 7 through 12 places virtual display “B” immediately below virtual display “A” on the screen. See Figure 2-1.

Screen Management Output Operations

2.1 Composition Operations

Figure 2-1 Paste Operation

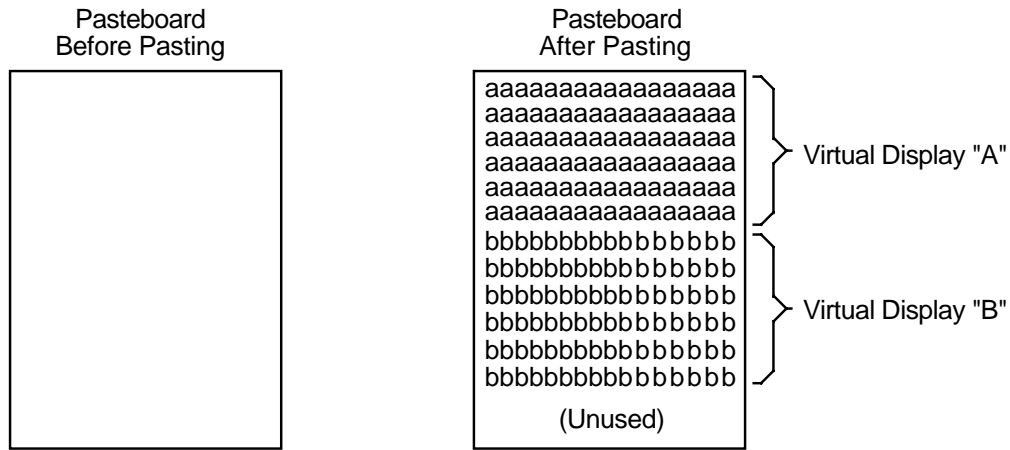

ZK-1911-GE

2.1.2 Unpaste Operation

You can make a virtual display disappear from the physical screen using the `SMG$UNPASTE_VIRTUAL_DISPLAY` routine. To continue the example in Section 2.1.1, if virtual display "B" is unpasted, the results appear as in Figure 2-2.

Figure 2-2 Unpaste Operation

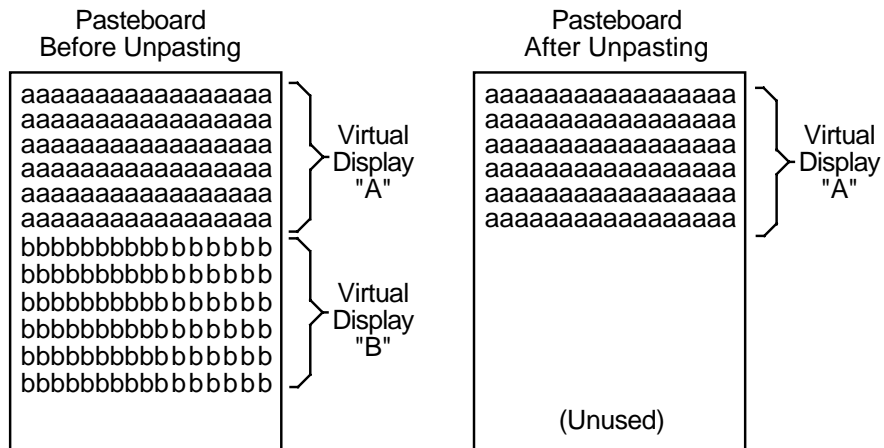

ZK-1912-GE

Unpasting a virtual display does not destroy the virtual display or its contents; it simply removes the display from the pasteboard.

Displays can overlap partially or completely, depending on their size, where they are pasted, and the order in which they are pasted. This overlap is called **occlusion**. Unpasting the top display causes the underlying displays to be visible.

2.1.3 Repaste Operation

You can move a virtual display to a new location on the pasteboard by calling `SMG$REPASTE_VIRTUAL_DISPLAY`, which prevents the screen from being left blank during the unpaste and repaste operations. Figure 2-3 shows the effect of repasting the second display farther to the right. Notice that display 2 has been pulled out of its former pasting order and is now uppermost — hiding part of display 3, which was uppermost before the repasting operation.

Figure 2-3 Repaste Operation

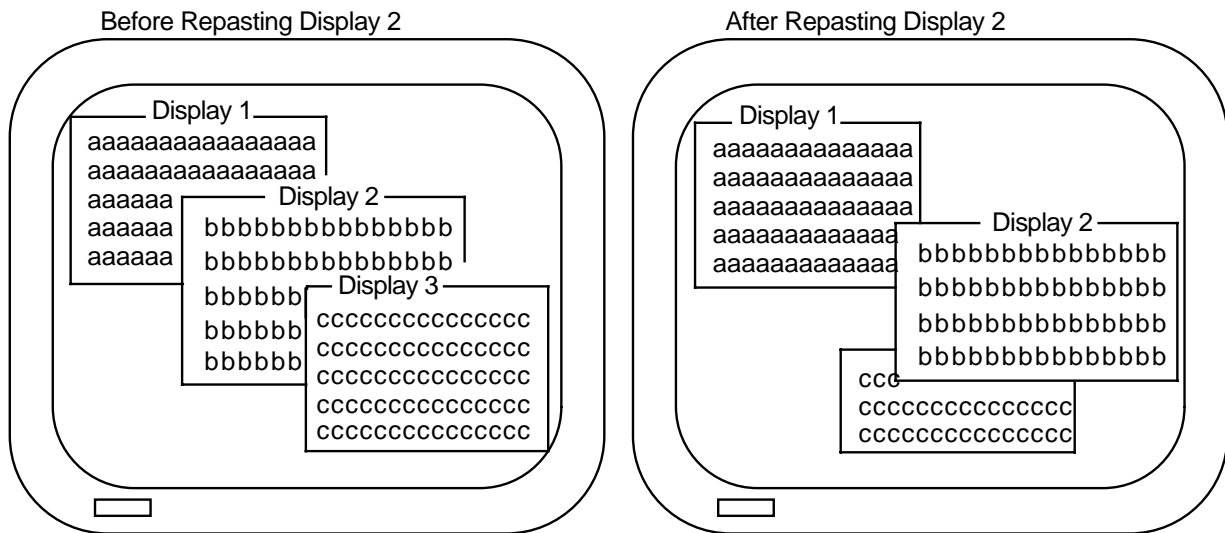

ZK-1918-GE

2.1.4 Move Operation

You can also move a virtual display around the pasteboard while preserving its pasting order by calling the `SMG$MOVE_VIRTUAL_DISPLAY` routine. Figure 2-4 shows the effect of moving the second display to the right. Note the difference between the unpaste and move operations: the pasting order does not change with a move. Thus, display 2 remains partially occluded by display 3.

Screen Management Output Operations

2.1 Composition Operations

Figure 2-4 Move Operation

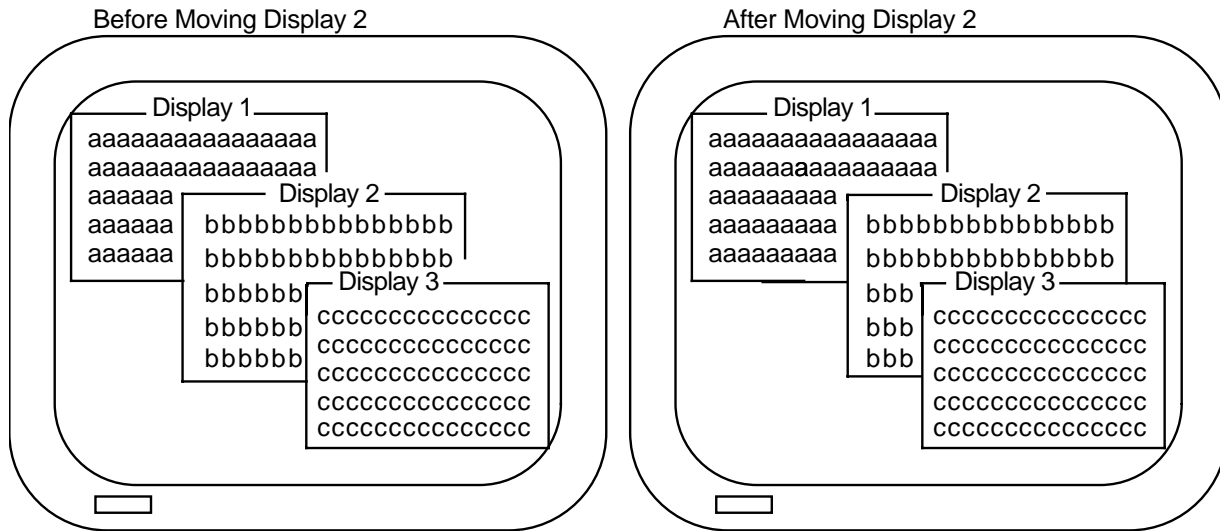

ZK-1913-GE

The routine `SMG$MOVE_TEXT` allows you to move text from one virtual display to another virtual display. Given two points in opposite corners of the rectangle, `SMG$MOVE_TEXT` determines the desired width and height. This routine moves the attributes of the first virtual display, thus moving the rectangle of text and erasing it from the first virtual display.

2.1.5 Delete and Pop Operations

The unpaste, repaste, and move operations shown thus far do not destroy the virtual displays affected. You can remove and delete a virtual display by calling the `SMG$DELETE_VIRTUAL_DISPLAY` routine. You can also remove a number of virtual displays from a pasteboard and delete them in a single operation by calling `SMG$POP_VIRTUAL_DISPLAY`. This routine unpastes and deletes the specified virtual display and all other virtual displays that were pasted after the one specified.

The pop operation is useful in a modular environment. For example, you can call a subroutine and pass only the **pasteboard-id** upon which it is to produce output. The subroutine then creates additional virtual displays and pastes them to the indicated pasteboard. When the subroutine returns control to its caller, it returns the **display-id** of the first virtual display it has pasted. The calling program can then undo the effects of the subroutine by calling `SMG$POP_VIRTUAL_DISPLAY`, passing the identifier of the virtual display returned by the subroutine. This technique minimizes the amount of information to be passed between the calling program and its subroutine. Figure 2-5 shows the effects of popping display 2.

Figure 2-5 Pop Operation

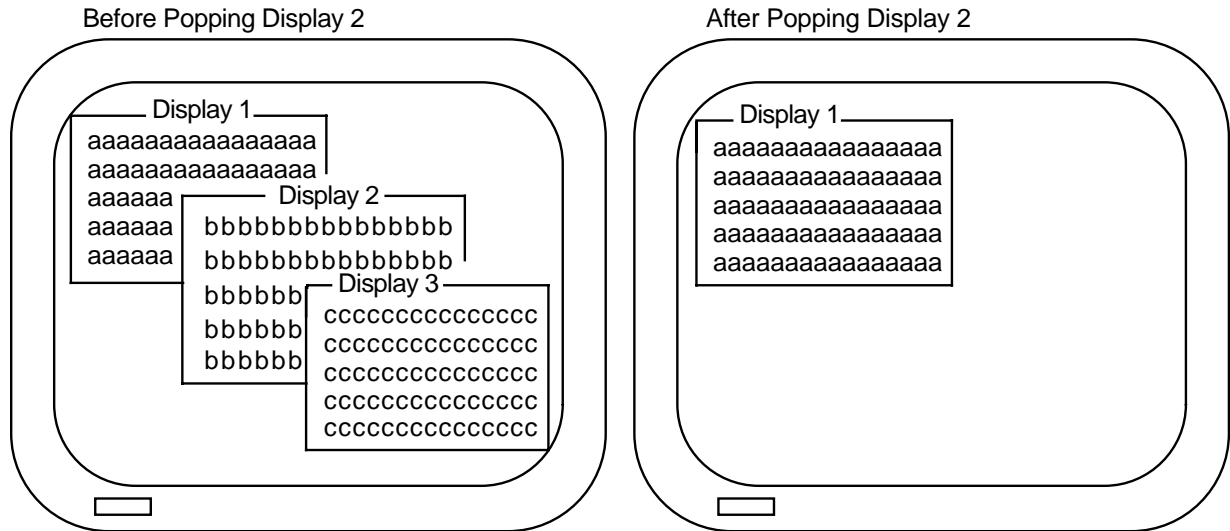

ZK-1914-GE

2.1.6 Occlusion Check Operation

You may want to know if a display is occluded, as pasted on a given pasteboard. You can find this out by calling the `SMG$CHECK_FOR_OCCLUSION` routine. For example, in the configuration in Figure 2-6, displays 1 and 2 would be reported as being occluded, while displays 3 and 4 would be reported as not occluded. You cannot use this test to determine which display is pasted uppermost on the pasteboard; it determines only whether or not the display, as pasted, is occluded.

If you have multiple virtual displays pasted to a pasteboard, you can use `SMG$LIST_PASTING_ORDER` to determine the order in which virtual displays are pasted. This routine returns the identifier of the first, or bottommost, virtual display pasted. Call `SMG$LIST_PASTING_ORDER` in a loop until the identifiers of all the succeeding pasted virtual displays are returned.

The routine `SMG$LIST_PASTEBOARD_ORDER` gives you the inverse of the information returned by `SMG$LIST_PASTING_ORDER`. `SMG$LIST_PASTEBOARD_ORDER` returns the identifier of the first, or bottommost, pasteboard to which the specified virtual display is pasted.

2.2 Output Through Virtual Displays

This section describes the screen management routines used to perform output through virtual displays.

Writing to a virtual display is similar to writing directly to the terminal. However, writing to a virtual display is done entirely by calling screen management routines. The Screen Management Facility allows you to erase the screen, set the cursor position, and scroll output text. Text is arranged in the

Screen Management Output Operations

2.2 Output Through Virtual Displays

Figure 2–6 Occlusion Check

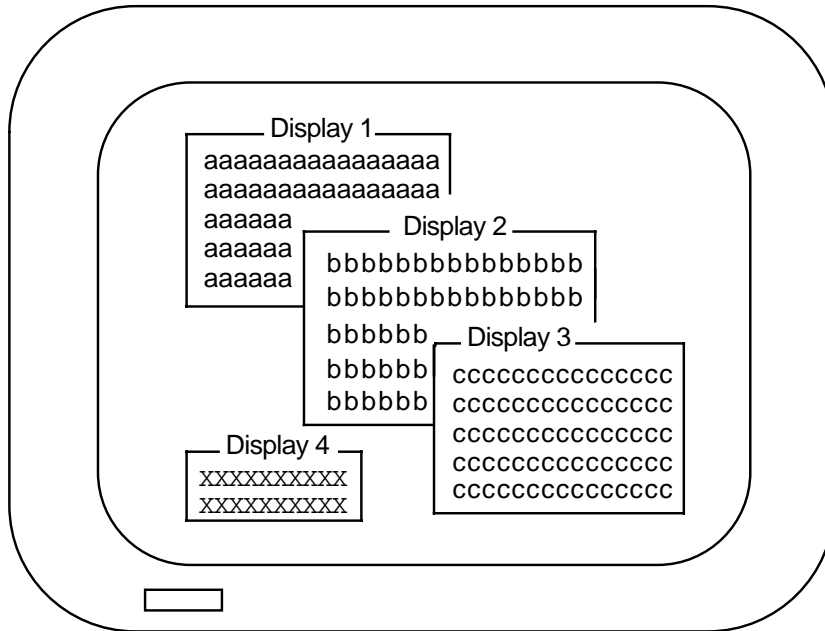

ZK-1915-GE

virtual display's buffer, so you do not need to paste before it can receive output. When you write to the physical screen, you are limited by the physical boundaries of the screen. Similarly, screen management output operations are confined to the boundaries of the virtual display: you cannot write text beyond the last column of a virtual display.

You cannot see changes to a virtual display on the screen unless the virtual display is pasted to the part of the pasteboard that is visible on the screen. If the virtual display is not pasted, or if it is pasted in a position that is not visible, such changes are reflected only in the internal database that represents the virtual display.

2.2.1 Cursor Position

When a virtual display is first created, the virtual cursor is positioned at row 1, column 1 of the virtual display. Various output operations to the virtual display move the virtual cursor, just as output operations do on a physical terminal.

Do not confuse the position of the virtual cursor in a virtual display with the position of the physical cursor on the screen. Many virtual displays can be pasted to a pasteboard and are therefore visible at the same time on the physical screen. Although each virtual display has an associated virtual cursor position, only one of the virtual cursor positions for all these displays corresponds to the physical cursor—usually the cursor position of the virtual display most recently modified.

You can determine the current position of the virtual cursor within a virtual display by calling the `SMG$RETURN_CURSOR_POS` routine. This routine returns the current virtual cursor row and column.

Screen Management Output Operations

2.2 Output Through Virtual Displays

For programming convenience, you can also obtain this information through two separate routines, `SMG$CURSOR_ROW` and `SMG$CURSOR_COLUMN`, which operate as functions. These two routines make it easy to code constructions like this:

```
IF SMG$CURSOR_ROW ( Display-id ) > Max-row
THEN
  BEGIN
    .
    .
    .
  END
```

To obtain this information with `SMG$RETURN_CURSOR_POS`, you would write the following:

```
CALL SMG$RETURN_CURSOR_POS ( Display-id, Cursor-row, Cursor-column )
IF Cursor-row > Max-row
  THEN
    BEGIN
      .
      .
      .
    END
```

`SMG$RETURN_CURSOR_POS` requires you to define two local variables, *cursor-row* and *cursor-column*, which you might not need except to perform this test. However, this routine yields both the row and column in a single routine call.

The following routines set the virtual cursor position in a virtual display:

- `SMG$SET_CURSOR_ABS` sets the virtual cursor to the specified position in the virtual display.
- `SMG$SET_CURSOR_REL` sets the virtual cursor position to the specified offset from the current display cursor position.
- `SMG$HOME_CURSOR` sets the virtual cursor to the virtual display's home position (row 1, column 1).

2.2.2 Deletion Operations

The following routines delete parts of a virtual display:

- `SMG$DELETE_CHARS` deletes one or more characters on a single line. Character positions removed by this routine are replaced with the characters to the right of the deleted characters on the same line. Character positions opened at the end of the line are filled with blanks.
- `SMG$DELETE_LINE` deletes one or more entire lines. Lines removed by this routine are filled by the lines immediately below the deleted lines. New lines introduced into the bottom of the virtual display are blank.

Screen Management Output Operations

2.2 Output Through Virtual Displays

2.2.3 Erasure Operations

During an erase operation, the erased portion of the virtual display is filled with blanks. No other parts of the virtual display are rearranged.

The following routines erase parts of a virtual display:

- `SMG$ERASE_CHARS` erases a specified number of characters within a given line.
- `SMG$ERASE_COLUMN` erases the specified portion of the virtual display from the given position to the end of the column.
- `SMG$ERASE_LINE` erases characters in a line from the specified starting position to the end of the line.
- `SMG$ERASE_DISPLAY` erases all or part of a virtual display.

2.2.4 Insertion Operations

The following routines insert text into a virtual display:

- `SMG$INSERT_CHARS` deposits the specified string of characters in the indicated starting position. Existing characters in these positions are shifted to the right to make room for each character as it is inserted. Characters shifted beyond the rightmost column are discarded.
- `SMG$INSERT_LINE` inserts the specified line of text in the position indicated and scrolls existing lines in the virtual display up or down to make room for the inserted lines. Lines scrolled above the top line or below the bottom line of the virtual display are discarded.

2.2.5 Writing Operations

The Screen Management Facility provides two types of routines for writing text to a virtual display: character-oriented output and line-oriented output. The following sections describe these routines.

2.2.5.1 Character-Oriented Output

Use the character-oriented output routines when you are using a virtual display as a direct-access device. In this mode of operation, the program explicitly sets the cursor in the virtual display and deposits text there. Since the next output operation usually has no spatial relationship to the previous one, you need to control the cursor position and display scrolling.

The following are character-oriented output routines:

- `SMG$PUT_CHARS` writes normal characters to a virtual display.
- `SMG$PUT_CHARS_WIDE` writes double-width characters to a virtual display.
- `SMG$PUT_CHARS_HIGHWIDE` writes double-width, double-height characters to a virtual display.
- `SMG$PUT_CHARS_MULTI` writes characters with multiple renditions to the virtual display.

You cannot mix different types of characters on a single line in a virtual display.

2.2.5.2 Line-Oriented Output

In contrast to the character-oriented output routines, the line-oriented routines treat a terminal as a sequential device. In this mode of operation, the program typically writes one line of information after another. Conceptually, this action corresponds to copying a stream of information (for example, a file) to a virtual display. Each routine call leaves the cursor at column 1 of the next row after the operation is complete.

The following are line-oriented output routines:

- `SMG$PUT_LINE` writes lines of text to a virtual display.
- `SMG$PUT_LINE_WIDE` writes lines of double-width text to a virtual display.
- `SMG$PUT_LINE_HIGHWIDE` writes lines of double-width, double-height text to a virtual display.
- `SMG$PUT_LINE_MULTI` writes lines with multiple renditions to the virtual display.

2.2.6 Changing the Rendition of a Virtual Display

When you create a virtual display with the `SMG$CREATE_VIRTUAL_DISPLAY` routine, you specify a default rendition for all text that appears in the virtual display. You can change the rendition for an existing virtual display by calling either the `SMG$CHANGE_VIRTUAL_DISPLAY` or `SMG$CHANGE_RENDITION` routines.

The `SMG$CHANGE_VIRTUAL_DISPLAY` routine lets you change display attributes as well as video attributes for the entire display; you can use the `SMG$CHANGE_RENDITION` routine to change the video rendition of text already in the virtual display. For example, a program may maintain on the screen a list of values that change cyclically. When a number first changes, it can be displayed in reverse video to highlight it as a change on that cycle. On the next cycle, the same number must be displayed, but the reverse video should be removed, since the value of the number did not change. `SMG$CHANGE_RENDITION` provides an easy way to perform such changes.

Another use for the `SMG$CHANGE_RENDITION` routine is in implementing menus. Menu choices can be painted on the screen and the current choice highlighted by some video attribute, such as blinking characters or reverse video. As the user moves a cursor to change the selection, you can change the rendition of a menu item so that the current selection is always highlighted. Such changes in rendition can be made independently of the text contained in the menu choices.

To specify the default rendition for a virtual display, you use bit masks to set bits in the display attributes argument. You can set the following bits:

| | |
|-------------------------------|---|
| <code>SMG\$M_BLINK</code> | Specifies blinking characters. |
| <code>SMG\$M_BOLD</code> | Specifies characters in higher-than-normal intensity. |
| <code>SMG\$M_REVERSE</code> | Specifies characters in reverse video; that is, the opposite of the current rendition of the virtual display. |
| <code>SMG\$M_UNDERLINE</code> | Specifies underlined characters. |
| <code>SMG\$M_INVISIBLE</code> | Specifies invisible characters; that is, the characters exist in the virtual display but do not appear on the pasteboard. |

Screen Management Output Operations

2.2 Output Through Virtual Displays

SMG\$M_USER1 through SMG\$M_USER8 Specifies a user-defined rendition.

In order to use one of the user-defined renditions SMG\$M_USER1 through SMG\$M_USER8, you must provide an appropriate definition in the file TERMTABLE.TXT, using STRING_2 capabilities. The TERMTABLE definitions and STRING_2 capabilities are discussed in Chapter 5.

Any or all of the characteristics listed previously can be specified in the rendition of a virtual display. To specify more than one video attribute, you use the logical OR of these characteristics. For example, to specify underlined characters in reverse video as the default for a virtual display, you assign the logical OR of the appropriate bit masks to the **display-attributes** argument:

```
Display_attributes = ( SMG$M_REVERSE OR SMG$M_UNDERLINE )
```

You then pass this **display-attributes** argument in the call to the SMG\$CREATE_VIRTUAL_DISPLAY routine.

Screen management output routines let you override the default rendition so that you need not change the default each time you want to write text in some other rendition. Two arguments provide the means to override the default rendition: **rendition-set** and **rendition-complement**. The scheme for setting video attributes in these arguments is the same as that for setting the video attributes when you are creating a virtual display.

The default video attributes, the **rendition-set** argument, and the **rendition-complement** argument together specify the output rendition according to the following scheme:

1. The logical or bitwise OR operation is performed on the mask containing the default video attributes and the **rendition-set** argument.
2. The logical or bitwise EXCLUSIVE OR operation is performed on the result of the previous OR operation and the **rendition-complement** argument.

The results of this scheme are shown in the following table:

| Set | Complement | Action |
|-----|------------|--|
| 0 | 0 | Attribute set to default |
| 1 | 0 | Attribute on |
| 0 | 1 | Attribute set to complement of default setting |
| 1 | 1 | Attribute off |

Note that the effect of this scheme depends on the default attribute setting, not the current rendition of the virtual display. Thus, if you have used screen management output routines that explicitly specify a rendition, the current rendition may not match the default rendition for that virtual display.

2.2.7 Drawing and Removing Drawn Lines and Characters

The following routines provide a simple way to construct horizontal and vertical lines:

- SMG\$DRAW_LINE constructs either horizontal or vertical lines, given the end points of those lines.
- SMG\$DRAW_RECTANGLE draws a rectangle given the position of the upper left-hand corner and the lower right-hand corner.
- SMG\$DRAW_CHAR draws one line-drawing character.

If you want to erase a line drawn with SMG\$DRAW_LINE or SMG\$DRAW_RECTANGLE, use SMG\$REMOVE_LINE. This routine removes the line but preserves the line-drawing characters at any line intersections.

Like all screen management routines, these are device independent. If the resulting line is to be drawn on a VT100 terminal, the VT100 line-drawing character set is used. If the same line is drawn on a VT52 terminal (which does not have this hardware capability), the lines are automatically approximated by the use of the plus sign (+), the vertical bar (|), and the dash (-). Your program does not have to supply different character codes for different types of terminals.

In addition, these routines automatically provide an appropriate character at the intersection of two lines. For example, if a program writes a horizontal line directly to the screen and then writes a vertical line that intersects the horizontal line, you would normally see what appears in Figure 2-7.

Figure 2-7 Lines Drawn Without SMG\$DRAW_LINE

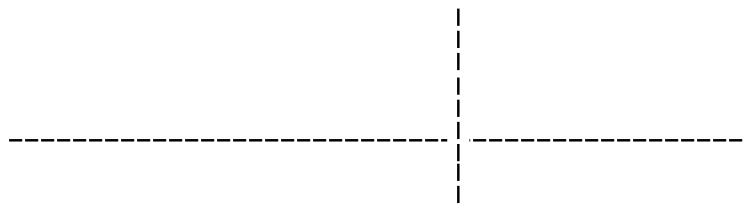

ZK-1916-GE

If these same lines are drawn using SMG\$DRAW_LINE, the screen shows what appears in Figure 2-8.

Figure 2-8 Lines Drawn With SMG\$DRAW_LINE

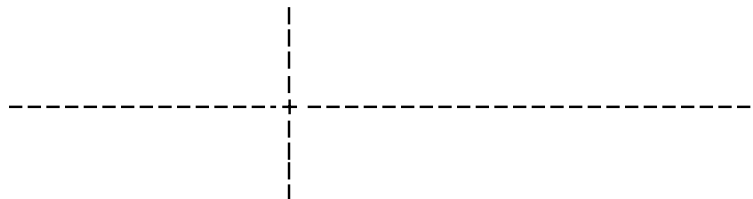

ZK-1917-GE

Screen Management Output Operations

2.2 Output Through Virtual Displays

2.2.8 Displaying External Text

The following routines provide a way to output external text to the virtual display or terminal:

- `SMG$PUT_HELP_TEXT` outputs the help text for the specified topic in the virtual display provided.
- `SMG$PUT_STATUS_LINE` outputs a line of text to the terminal's hardware status line. Some terminals have a hardware status line at the bottom (25th line) of the screen. If this line has been set as *host writable*, you can use this routine to output a line of text in reverse video to the status line.

2.2.9 Reading from a Virtual Display

The `SMG$READ_FROM_DISPLAY` routine makes it easy to obtain text from a virtual display. This routine might be used in applications that present menu items on the screen by way of a virtual display. The application might allow the user to move the cursor among the menu items and then select one (by pressing the Return key, for example). At this point, the program can read characters from the display at the current cursor position and determine which menu item was selected. Note that this routine also provides a way to read characters written with the `SMG$M_INVISIBLE` attribute.

2.2.10 Viewports

Since a virtual display can be very large, it is not always possible to show the entire display on the screen at one time. The user must repaste a large virtual display in order to view a different portion of it. A viewport associated with the virtual display makes this job easier.

Viewporting refers to the process of moving a rectangular viewing area around on a virtual display in order to view different pieces of the virtual display. The viewport is associated with the virtual display so that any output operation performed on the virtual display is reflected on the viewport.

2.2.10.1 Creating a Viewport

The `SMG$CREATE_VIEWPORT` routine creates a viewport associated with a particular virtual display. The virtual display must be created before the viewport can be created, and you can only create one viewport for each virtual display. In order to make the viewport visible, you have to paste the virtual display by calling the `SMG$PASTE_VIRTUAL_DISPLAY` routine; only the portion of the virtual display that falls inside the viewport is visible.

2.2.10.2 Deleting a Viewport

The `SMG$DELETE_VIEWPORT` routine deletes a viewport. When you invoke this routine, the viewport is automatically unpasted from any pasteboards to which it is pasted. It is important to note, however, that the virtual display associated with the viewport has not been deleted. You can make the virtual display visible by calling `SMG$PASTE_VIRTUAL_DISPLAY`.

2.2.10.3 Pasting and Unpasting a Viewport

The `SMG$PASTE_VIRTUAL_DISPLAY` routine pastes either a viewport or a virtual display to a pasteboard. Once you have associated a viewport with a virtual display, any call to `SMG$PASTE_VIRTUAL_DISPLAY` uses the viewport instead of the virtual display. That is, once a viewport for a virtual display is created, the only part of that virtual display that you can view is the rectangular region contained in the viewport. To unpaste a viewport without deleting it, you can invoke `SMG$UNPASTE_VIRTUAL_DISPLAY`.

If you create a viewport when the associated virtual display is already pasted, the viewport is not visible. A call to `SMG$PASTE_VIRTUAL_DISPLAY` unpastes the virtual display and pastes the viewport in its place.

2.2.10.4 Scrolling and Moving a Viewport

A viewport associated with a virtual display may be situated entirely or partially on the pasteboard, or totally off the pasteboard. However, a viewport cannot extend beyond its associated virtual display. If you try to extend a viewport beyond the boundaries of its virtual display, the Screen Management Facility automatically truncates the viewport to fit into the virtual display.

To scroll a viewport, scroll the virtual display associated with the viewport by calling `SMG$SCROLL_VIEWPORT`. In actuality, the coordinates of the viewport are changing as it moves over the virtual display to simulate scrolling; however, the location of the viewport on the screen does not change. With the `SMG$SCROLL_VIEWPORT` routine, you can specify the direction (up, down, left, or right) that you want to scroll.

You can move a viewport by calling `SMG$CHANGE_VIEWPORT`. This routine lets you specify a new starting location and size for the viewport. By changing the starting location and size of the viewport, you can, in effect, move the window around the virtual display.

2.2.10.5 Changing Viewport Characteristics

The `SMG$GET_VIEWPORT_CHAR` routine lets you retrieve the current characteristics of a viewport. The characteristics of a viewport consist of the starting and ending row and column positions for the viewport. You can use this routine in conjunction with the `SMG$CHANGE_VIEWPORT` routine, which lets you change the starting and ending positions of an existing viewport.

To change any characteristic of a viewport other than its starting or ending position, use the `SMG$CHANGE_VIRTUAL_DISPLAY` routine. Any change you make to a virtual display is reflected in its associated viewport.

For example, if a virtual display has a border, so does the associated viewport. If the virtual display does not have a border, then neither does the viewport. If you want to add or delete a border to a viewport, add or delete the border to the virtual display using the `SMG$CHANGE_VIRTUAL_DISPLAY` routine. This change is automatically reflected on the viewport.

2.2.11 Menus

The Screen Management Facility provides the capability to create and make selections from a menu. The menu can be a block menu, a vertical menu, or a horizontal menu. A block menu is a two-dimensional array of items and is the main type of menu provided. A vertical menu displays the menu choices in a single column, while a horizontal menu displays the choices in a single row. Any menu items that do not fit within the bounds of the viewport are not displayed until they are scrolled into view.

Screen Management Output Operations

2.2 Output Through Virtual Displays

2.2.11.1 Creating a Menu

The SMG\$CREATE_MENU routine creates a menu in the scrolling region of a specified virtual display. (By default, the scrolling region is the entire virtual display. You can use SMG\$SET_DISPLAY_SCROLL_REGION to change the scrolling region.) Specify a format for the menu (block, vertical, or horizontal) when you create it.

A block menu is the default format for a menu. The items in the menu are passed to the routine in the form of a static array of character strings. The menu choices are single spaced by default, but you can request double spacing. Four spaces separate each menu item horizontally. In addition, you can request that the menu choices be displayed in *fixed format* columns, where the width of the column is equal to the size of the fixed-length strings being passed.

It is important to note that each virtual display can only contain one menu. Also, after calling SMG\$CREATE_MENU, you must not output any characters to the display that disturb the area containing the menu; otherwise, the results are unpredictable. The menu is output in the scrolling region of the virtual display.

2.2.11.2 Deleting a Menu

The SMG\$DELETE_MENU routine deletes a menu by discontinuing access to the menu choices in the specified virtual display. Additionally, you can request that SMG\$DELETE_MENU remove all menu choices from the display when the menu is deleted.

2.2.11.3 Selecting from a Menu

Once you have created a menu, you can select items from that menu using the SMG\$SELECT_FROM_MENU routine. When you move around the menu items, the currently selected item is highlighted in reverse video by default. You can specify a default selection that is highlighted and becomes the current item when you call SMG\$SELECT_FROM_MENU. If you do not specify a default selection item, the previously selected item remains highlighted.

SMG\$SELECT_FROM_MENU provides three modes of operation; you can switch between these modes using the **flags** parameter. Each mode is described in the following sections.

2.2.11.3.1 Default Mode The default mode of operation for the SMG\$SELECT_FROM_MENU routine is invoked by omitting the **flags** parameter. In this mode, you can move around the menu items using the arrow key and, after selecting an item, you can continue making additional selections. The default mode also lets you “reselect” items that were already selected.

2.2.11.3.2 RETURN_IMMEDIATE Mode Specifying the SMG\$M_RETURN_IMMEDIATE value for the **flags** parameter of the SMG\$SELECT_FROM_MENU routine allows you to move around the menu choices with the arrow keys; however, pressing any other key returns control to the user. Ctrl/Z selects the current item and returns SMG\$EOF. Any other key entered selects the current item.

Use SMG\$M_RETURN_IMMEDIATE mode if you want key definitions other than those provided by the default mode.

Screen Management Output Operations

2.2 Output Through Virtual Displays

2.2.11.3.3 REMOVE_ITEM Mode If you specify the `SMG$M_REMOVE_ITEM` value for the **flags** parameter of `SMG$SELECT_FROM_MENU`, you cannot “reselect” an item in the menu, although the item remains in the menu. It appears in the default rendition for the virtual display containing the menu.

If you specify a default selection item while in this mode, and that item has already been selected, the first “selectable” item in the menu is highlighted. If none of the items is selectable, an error is returned.

2.2.12 Saving a Virtual Display

The `SMG$SAVE_VIRTUAL_DISPLAY` routine saves the contents of a virtual display in a file. The text, renditions, and all the attributes needed to reconstruct the virtual display are saved, but menu, viewport, and subprocess contexts are not saved. You cannot print the resulting file. To restore the virtual display, you can use `SMG$LOAD_VIRTUAL_DISPLAY`, which creates a new virtual display and loads it with the saved contents of the display. The new virtual display is not pasted to any pasteboard.

2.2.13 Changing Terminal Characteristics

The `SMG$SET_TERM_CHARACTERISTICS` routine changes or retrieves the terminal characteristics for a given pasteboard. With this routine, you can control multiple terminal characteristics in a single routine call.

2.2.14 Hardcopy and File Output Operations

The Screen Management Facility provides a way for you to send output to a hardcopy device or to a file, instead of to a terminal screen. Although you cannot constantly update the display as you do with a video screen, you can capture the image of the current pasteboard at any point and send that image to either a hardcopy device or file.

Note

Terminals accessed using non-terminal devices such as network and mailbox devices are treated as files.

2.2.14.1 Snapshots

If the output device for a screen management routine is a file or a hardcopy terminal, the output for screen updating is inappropriate for the image. The `SMG$SNAPSHOT` routine sends the current screen image (that is, the visible portion of the pasteboard) to the file or hardcopy terminal. To determine if you should use `SMG$SNAPSHOT`, check the **type-of-terminal** parameter returned by `SMG$CREATE_PASTEBOARD`.

The `SMG$SNAPSHOT_TO_PRINTER` routine prints the current pasteboard contents to a printer attached to the terminal's printer port.

Pasteboard batching does not affect the `SMG$SNAPSHOT` or `SMG$SNAPSHOT_TO_PRINTER` routine. If you enable pasteboard batching with the `SMG$BEGIN_PASTEBOARD_UPDATE` routine, a buffer is created that saves all output to a pasteboard until you disable batching with a call to `SMG$END_PASTEBOARD_UPDATE`. When you call `SMG$SNAPSHOT` or `SMG$SNAPSHOT_TO_PRINTER`, you get a snapshot of that current pasteboard buffer — not what is possibly a stale screen image.

Screen Management Output Operations

2.2 Output Through Virtual Displays

2.2.14.2 Printing a Pasteboard

The `SMG$PRINT_PASTEBOARD` routine prints a pasteboard on a line printer. The routine creates a file and fills it with the contents of a specified pasteboard. Once the file is filled, `SMG$PRINT_PASTEBOARD` submits the file to the specified print queue.

2.2.14.3 Pasteboard Output by Means of a User-Supplied Routine

The `SMG$PUT_PASTEBOARD` routine lets you access the contents of a pasteboard. You specify an action routine that is called once for each line of the pasteboard. Using this action routine, you can perform whatever action is necessary for each row of the pasteboard returned.

2.3 Operational Controls

This section describes the screen management routines that control special modes of operation: minimal update, buffering, and whether or not tabs are used in updating. These modes let you optimize the manner in which information is actually written to the screen. To invoke these modes, use the `SMG$CONTROL_MODE` routine.

Normally, you need not be concerned with these modes; the Screen Management Facility optimizes output so that characters appear to be displayed on the screen immediately. For some applications, however, you may want to take advantage of these mode settings. The following sections describe these modes of operation.

2.3.1 Minimal Update

By default, the Screen Management Facility attempts to minimize the number of characters written to the screen by rewriting only the parts of the screen that have changed. However, the Screen Management Facility also supports nonminimal updating, in which all lines affected by a change are redrawn, beginning at the first changed character and continuing to the end of the line.

2.3.2 Buffering

By default, output operations cause an immediate change on the screen by sending many small, partially filled buffers to the terminal instead of updating the screen when the buffer is full. Minimizing the number of these I/O transactions by enabling buffering mode results in faster program execution.

In buffering mode, the Screen Management Facility writes the terminal buffer to the screen only when the buffer is full. Thus, several output operations may be performed before the results appear on the screen. Because this delay is not acceptable for many applications, a special routine, `SMG$FLUSH_BUFFER`, is provided for use with buffering. `SMG$FLUSH_BUFFER` forces the buffer to be written to the terminal whether or not it is full. This routine is useful for an application that can usually accept delayed output but occasionally requires an immediate screen update. Applications that usually need immediate changes on the screen should not enable buffering.

2.3.3 Tabs

Tabs are used for minimal updating. When you are using tabs, you must ensure that the tab stops are set to the Compaq default locations. Do not use tabs if you want to be sure that the application will run regardless of the tab settings the user has set on the terminal.

Any tabs that you output to the screen are converted to eight spaces by SMG\$ before being output to the screen. The only exception to this is when using SMG\$CREATE_VIRTUAL_DISPLAY with the **display-attributes** argument set to SMG\$M_DISPLAY_CONTROLS. In this case, the tab character is printed rather than interpreted as eight spaces.

2.4 Batching Output Operations

If you want to construct a complex virtual display that requires several scrolling, cursor positioning, and output operations but do not want the interim steps to be visible, you can batch the output operations. Batching a series of operations to a virtual display lets the application hide the interim steps.

You may also want to construct a complex pasteboard image but have it appear on the screen only after the entire picture is complete. Unpasting and repasting leaves the screen blank during the construction process, so in this case you can batch a series of composition operations and let the screen show only the final effect.

The Screen Management Facility provides a mechanism for batching a series of operations at both the virtual display level and the pasteboard level. These are described in the following sections.

2.4.1 Display Update Batching

The SMG\$BEGIN_DISPLAY_UPDATE routine causes output operations to a pasted display to be reflected only in the display's buffers. When all operations to the display are finished, the application can call the SMG\$END_DISPLAY_UPDATE routine, which causes the display's buffer to be written to the pasteboard.

The SMG\$BEGIN_DISPLAY_UPDATE and SMG\$END_DISPLAY_UPDATE routines increment and decrement a counter. When this counter's value is zero, output to the virtual display is immediately sent to the pasteboard. When the counter's value is nonzero, output operations are batched; the **display batching level** is equal to the counter's value. Notice that the counter mechanism allows a subroutine to request and turn off batching without disturbing the batching level of the calling program.

You can call SMG\$FLUSH_DISPLAY_UPDATE in place of a call to SMG\$END_DISPLAY_UPDATE that is immediately followed by a call to SMG\$BEGIN_DISPLAY_UPDATE, when the batch count is zero, with much better performance than the two calls.

2.4.2 Pasteboard Update Batching

You accomplish pasteboard batching by calling the SMG\$BEGIN_PASTEBOARD_UPDATE routine, performing several composition operations, and finally calling the SMG\$END_PASTEBOARD_UPDATE routine. The SMG\$BEGIN_PASTEBOARD_UPDATE routine causes output operations to be reflected only in the pasteboard buffer, not on the physical screen. The SMG\$END_PASTEBOARD_UPDATE routine causes the pasteboard buffer to be written to the physical screen.

The SMG\$BEGIN_PASTEBOARD_UPDATE and SMG\$END_PASTEBOARD_UPDATE routines increment and decrement a counter. When this counter's value is zero, output to the pasteboard is immediately sent to the physical screen. When the counter's value is nonzero, output operations are batched; the **pasteboard batching level** is equal to the value of the counter. Notice that the

Screen Management Output Operations

2.4 Batching Output Operations

counter mechanism allows a subroutine to request and turn off batching without disturbing the batching level of the calling program.

Screen Management Input Operations

This chapter describes the screen management routines used to perform input from a virtual keyboard. Remember that while a virtual keyboard is usually associated with a terminal, it may also be associated with any OpenVMS RMS file to which you have access. If the RMS file is on another node in a network, you may need a valid account for that node.

The Screen Management Facility provides a flexible set of routines for performing input from a terminal or a file. The input routines can be used with the output routines, or they can be used by themselves. You establish an input source, called a virtual keyboard, by calling the `SMG$CREATE_VIRTUAL_KEYBOARD` routine. You delete a virtual keyboard by calling the `SMG$DELETE_VIRTUAL_KEYBOARD` routine.

A virtual keyboard is a logical structure for input operations, just as a pasteboard is a logical structure for output operations. The advantage of using virtual keyboards is device independence. When using the screen management input routines, you need not worry about the type of terminal being used. For example, your program need not know which line terminators a particular terminal uses; the screen management routines map the different terminator character sequences into a uniform set of function codes. (See Section 3.6 for more information about terminator codes.) Virtual keyboards are also important for processing function/keypad keys.

3.1 Obtaining Data from Virtual Keyboards

Data may be obtained from a virtual keyboard in the following ways:

- `SMG$READ_STRING` reads a string composed of characters and a terminator. This flexible routine provides access to many features of the OpenVMS terminal driver.
- `SMG$READ_COMPOSED_LINE` reads a line composed of ordinary keystrokes and predefined strings associated with keypad and function keys; it provides an easy way to code an interface for command-oriented utilities by providing single-key command capabilities.
- `SMG$READ_KEYSTROKE` reads one keystroke entered at the keyboard. It reads function/keypad keys as well as alphanumeric keys.
- `SMG$READ_VERIFY` reads a string and verifies that string against a user-supplied picture string.

All read operations can be aborted by calling the `SMG$CANCEL_INPUT` routine.

Screen Management Input Operations

3.2 Obtaining Data from a Mouse or Tablet

3.2 Obtaining Data from a Mouse or Tablet

You can read information from a workstation terminal's locator device, such as a mouse or a tablet, by calling `SMG$READ_LOCATOR`. (This routine does not read locator information from the VT300 series terminals.) This routine tells you at which row and column the locator is pointing and which button was pressed.

3.3 Setting and Retrieving Virtual Keyboard Characteristics

In the same way that you can retrieve information about and set pasteboard characteristics, the Screen Management Facility also provides routines that let you retrieve and set the characteristics of a virtual keyboard.

The `SMG$GET_KEYBOARD_ATTRIBUTES` routine retrieves requested information about a virtual keyboard. It deposits this information in a user-supplied area called the keyboard information table (KIT). The information returned includes the following:

- The current device characteristics
- The device class
- The size of the recall buffer
- The physical device type
- The first character in the type-ahead buffer
- The terminal width
- The number of characters in the type-ahead buffer

You can use `SMG$SET_KEYPAD_MODE` to set the terminal's numeric keypad to either numeric or applications mode. In applications mode, numeric keypad keys are considered function keys and may be used as terminators. In numeric mode, these keys are equivalent to the corresponding keys on the main keyboard. Note that the terminal must support applications mode, or the call to `SMG$SET_KEYPAD_MODE` will fail.

3.4 Line Composition Using Keypad Keys

In addition to the functions provided by `SMG$READ_STRING`, line composition with keypad keys provides a powerful and flexible tool for applications that have line-oriented commands (for example, utilities that use the Command Definition Utility). (See the *OpenVMS Command Definition, Librarian, and Message Utilities Manual* for more information.)

With line composition, you can define certain keys (discussed below) to be equivalent to a string of characters. When you enter a line and press one of these keys, the equivalence string for that key is inserted into the returned command string. For example, if the application defines the key PF2 to have the equivalence string "HELP", then when you press the PF2 key, that command is returned to the application. You can also specify that the equivalence string be echoed; in this case, the string "HELP" is echoed. The recognition of keypad keys and the insertion of the equivalence string are handled automatically by `SMG$READ_COMPOSED_LINE`; the application treats the returned line just as if you had typed the entire line.

Screen Management Input Operations

3.4 Line Composition Using Keypad Keys

Key definitions are placed in a key definition table, which is created by a call to SMG\$CREATE_KEY_TABLE. Key definitions can be added to and deleted from the table by calls to SMG\$ADD_KEY_DEF and SMG\$DELETE_KEY_DEF. Key definitions can also be added by calls to SMG\$DEFINE_KEY and SMG\$LOAD_KEY_DEFS; these routines accept a DCL command DEFINE/KEY (or a file of these commands). See the description of these routines for more information; see the *OpenVMS DCL Dictionary* for an explanation of the DEFINE/KEY command.

All keyboard keys can be defined by calling SMG\$ADD_KEY_DEF and can be used with SMG\$READ_COMPOSED_LINE. Other definable keys include the function and keypad keys listed in Table 3-1, the control key sequences (Ctrl/A through Ctrl/Z), and line editing keys if line editing is disabled.

A key definition has several attributes. The TERMINATE attribute specifies whether the input line is terminated when this key is pressed; the NOTERMINATE attribute specifies that more characters and keystrokes may be entered. TERMINATE is the default.

The ECHO attribute specifies whether the equivalence string is echoed when the key is pressed. ECHO is the default.

The PROTECT attribute specifies whether this key definition can be changed or deleted once it is defined. NOPROTECT is the default.

The remaining attributes are LOCK_STATE, IF_STATE, and STATE. They are described in the following section.

3.5 States

A given key may have many definitions, depending on the value of the current state; the state is used to determine the meaning of the key. For example, if PF1 is defined as setting the state to "GOLD" and if PF2 with IF_STATE="GOLD" is defined as "HELP **", pressing PF1 and then PF2 would result in "HELP **" being returned as the command line. Note that in this case the PF1 definition would have no equivalence string and would specify the NOTERMINATE attribute.

A state name is any string comprising up to 31 alphanumeric characters, and can include the dollar sign (\$) and underscore (_). When a line is being composed from normal keystrokes and equivalence strings, SMG\$READ_COMPOSED_LINE maintains a string called the *current state name*. Before the first key is pressed, the current state is "DEFAULT". If you press a key whose definition has specified a value for the STATE attribute, the current state is changed to the specified state. Unless you specify the LOCK_STATE attribute, the state name reverts to "DEFAULT" after the next defined key is pressed.

3.6 Terminators

A terminator ends a transfer of data from the virtual keyboard. A terminator may be a single character such as a carriage return or Ctrl/Z, a character sequence (escape sequence) generated by pressing a function key on a keyboard, or a condition such as timeout or buffer full.

The terminator is not part of the data read from the virtual keyboard; it is returned to the caller in a separate argument as an integer (unsigned word) value.

Screen Management Input Operations

3.6 Terminators

3.6.1 Single-Character Terminators

For single-character terminators, the value is the terminator's 8-bit character code. Single-character terminator codes are in the range 0 through 255.

For calls to `SMG$READ_STRING` and `SMG$READ_VERIFY`, the default single character terminators are all the characters in the range 0 through 31 except backspace (8), horizontal tab (9), line feed (10), vertical tab (11), and form feed (12). Note that these characters make up the default terminator set for the OpenVMS terminal driver. However, any 8-bit character code is potentially a terminator.

The set of terminator characters may be changed by calls to `SMG$READ_STRING` or `SMG$READ_VERIFY`. For calls to `SMG$READ_COMPOSED_LINE`, the only default single terminator characters are the carriage return (13) and Ctrl/Z (26). Changes to the terminator set for `SMG$READ_COMPOSED_LINE` are made by key definitions; see the description of line composition in Section 3.4 for more information.

Behavior of input operations may vary in response to a Ctrl/Z. Under certain conditions, a Ctrl/Z in the input stream terminates the current read operation as well as the next read operation. You may need to issue an additional read to satisfy the Ctrl/Z.

3.6.2 Character Sequence Terminators

Character sequence terminators are returned in a device-independent fashion. The codes are in the form `SMGSK_TRM_keyname` (for example, `SMGSK_TRM_DELETE`). A unique code is assigned to each possible function key on VT220 (and VT200-compatible) terminals. Key codes on other terminals are returned using the code of the equivalent VT220 key. Therefore, the application program need not know which type of terminal is being used; the screen management routines transparently map the different terminator character sequences into a uniform set of function codes.

Table 3-1 lists the terminator name or condition for each terminator that is not a single character. The table also lists the code and the key legend for each terminator on the different types of terminals supported by the screen management input routines.

Screen Management Input Operations 3.6 Terminators

Table 3–1 Terminator Values

| Key Name | Value | VT200 and VT300 Series | VT100 | VT52 |
|--------------------------------|--------------------------------|---------------------------|-------------|----------------|
| Keypad Keys | | | | |
| DELETE | SMG\$K_TRM_DELETE | ⌫ | DELETE | DEL |
| PF1 | SMG\$K_TRM_PF1 | PF1 | PF1 | Blue |
| PF2 | SMG\$K_TRM_PF2 | PF2 | PF2 | Red |
| PF3 | SMG\$K_TRM_PF3 | PF3 | PF3 | Black |
| PF4 | SMG\$K_TRM_PF4 | PF4 | PF4 | |
| KP0 | SMG\$K_TRM_KP0 ¹ | 0 | 0 | 0 |
| KP1 | SMG\$K_TRM_KP1 ¹ | 1 | 1 | 1 |
| KP2 | SMG\$K_TRM_KP2 ¹ | 2 | 2 | 2 |
| KP3 | SMG\$K_TRM_KP3 ¹ | 3 | 3 | 3 |
| KP4 | SMG\$K_TRM_KP4 ¹ | 4 | 4 | 4 |
| KP5 | SMG\$K_TRM_KP5 ¹ | 5 | 5 | 5 |
| KP6 | SMG\$K_TRM_KP6 ¹ | 6 | 6 | 6 |
| KP7 | SMG\$K_TRM_KP7 ¹ | 7 | 7 | 7 |
| KP8 | SMG\$K_TRM_KP8 ¹ | 8 | 8 | 8 |
| KP9 | SMG\$K_TRM_KP9 ¹ | 9 | 9 | 9 |
| ENTER | SMG\$K_TRM_ENTER ² | ENTER | ENTER | ENTER |
| MINUS | SMG\$K_TRM_MINUS ¹ | – | – | |
| COMMA | SMG\$K_TRM_COMMA ¹ | , | , | |
| PERIOD | SMG\$K_TRM_PERIOD ¹ | . | . | |
| Cursor Positioning Keys | | | | |
| UP | SMG\$K_TRM_UP | Up arrow | Up arrow | Up arrow |
| DOWN | SMG\$K_TRM_DOWN | Down arrow | Down arrow | Down arrow |
| LEFT | SMG\$K_TRM_LEFT | Left arrow | Left arrow | Left arrow |
| RIGHT | SMG\$K_TRM_RIGHT | Right arrow | Right arrow | Right arrow |
| Function Keys | | | | |
| F6 | SMG\$K_TRM_F6 | F6 | | |
| F7 | SMG\$K_TRM_F7 | F7 | | |
| F8 | SMG\$K_TRM_F8 | F8 | | |
| F9 | SMG\$K_TRM_F9 | F9 | | |
| F10 | SMG\$K_TRM_F10 | F10 | | |
| F11 | SMG\$K_TRM_F11 | F11 | | |

¹These are the keys on the numeric keypad, not the main keyboard. These values are used only if the terminal keypad is in applications mode; if the keypad is in numeric mode, the keys are equivalent to the keys with the same legends on the main keyboard. See the description of SMG\$SET_KEYPAD_MODE for more information.

²If the keypad is in numeric mode, ENTER is equivalent to a carriage return. See the description of SMG\$SET_KEYPAD_MODE for more information.

(continued on next page)

Screen Management Input Operations

3.6 Terminators

Table 3–1 (Cont.) Terminator Values

| Key Name | Value | VT200 and VT300 Series | VT100 | VT52 |
|---------------------|---------------------------------|---------------------------|-------|------|
| F12 | SMG\$K_TRM_F12 | F12 | | |
| F13 | SMG\$K_TRM_F13 | F13 | | |
| F14 | SMG\$K_TRM_F14 | F14 | | |
| HELP | SMG\$K_TRM_HELP ³ | HELP | | |
| DO | SMG\$K_TRM_DO ³ | DO | | |
| F17 | SMG\$K_TRM_F17 | F17 | | |
| F18 | SMG\$K_TRM_F18 | F18 | | |
| F19 | SMG\$K_TRM_F19 | F19 | | |
| F20 | SMG\$K_TRM_F20 | F20 | | |
| Editing Keys | | | | |
| FIND | SMG\$K_TRM_FIND | Find | | |
| INSERT_HERE | SMG\$K_TRM_INSERT_HERE | Insert Here | | |
| REMOVE | SMG\$K_TRM_REMOVE | Remove | | |
| SELECT | SMG\$K_TRM_SELECT | Select | | |
| PREV_SCREEN | SMG\$K_TRM_PREV_SCREEN | Prev Screen | | |
| NEXT_SCREEN | SMG\$K_TRM_NEXT_SCREEN | Next Screen | | |
| Conditions | | | | |
| CANCELED | SMG\$K_TRM_CANCELLED | | | |
| TIMEOUT | SMG\$K_TRM_TIMEOUT | | | |
| BUFFER_FULL | SMG\$K_TRM_BUFFER_FULL | | | |
| UNKNOWN | SMG\$K_TRM_UNKNOWN ⁴ | | | |

³HELP and DO are in the F15 and F16 positions on the VT220 keyboard.

⁴If an unrecognized terminator is received, the value is SMG\$K_TRM_UNKNOWN.

3.6.3 Termination by a Condition

Input operations terminated by a condition are indicated by the terminator codes SMG\$K_TRM_CANCELLED, SMG\$K_TRM_TIMEOUT, SMG\$K_TRM_BUFFER_FULL, and SMG\$K_TRM_UNKNOWN. If the input is from an OpenVMS RMS file, each input operation reads one record from the file; the terminator code is always the code for a Return. (The only exception is SMG\$READ_KEYSTROKE, in which the terminator is the next character in the record.)

3.6.4 Key Name and Terminator Code Translation

The SMG\$NAME_TO_KEYCODE routine translates the name of a key on the keyboard to its corresponding terminator code, while SMG\$KEYCODE_TO_NAME translates the terminator code to the corresponding name of the key on the keyboard.

3.6.5 Symbolic Definitions of Terminator Values

Symbolic definitions of the terminator values are provided in symbol libraries named \$SMGDEF supplied by Compaq. For example, in a MACRO program you would issue a call to \$SMGDEF to extract these definitions. The symbol names are of the form SMG\$K_TRM_keyname, where **keyname** is the key name given in Table 3-1. For terminator codes 1 through 26, which correspond to the control sequences Ctrl/A through Ctrl/Z, the key names are CTRLA for Ctrl/A, CTRLB for Ctrl/B, and so on. The following synonyms are also defined:

| Symbol | Synonym |
|----------------|------------------------|
| SMG\$K_TRM_BS | SMG\$K_TRM_CTRLH |
| SMG\$K_TRM_HT | SMG\$K_TRM_CTRLI |
| SMG\$K_TRM_LF | SMG\$K_TRM_CTRLJ |
| SMG\$K_TRM_CR | SMG\$K_TRM_CTRLM |
| SMG\$K_TRM_E1 | SMG\$K_TRM_FIND |
| SMG\$K_TRM_E2 | SMG\$K_TRM_INSERT_HERE |
| SMG\$K_TRM_E3 | SMG\$K_TRM_REMOVE |
| SMG\$K_TRM_E4 | SMG\$K_TRM_SELECT |
| SMG\$K_TRM_E5 | SMG\$K_TRM_PREV_SCREEN |
| SMG\$K_TRM_E6 | SMG\$K_TRM_NEXTSCREEN |
| SMG\$K_TRM_F15 | HELP |
| SMG\$K_TRM_F16 | DO |

3.7 Line Recall and the Recall Buffer

The Screen Management Facility allows you to access and change the contents of the application recall buffer. By default, the recall buffer stores the previous 20 commands or data lines entered by the user to the application.

The SMG\$RETURN_INPUT_LINE routine lets you request a particular line from the recall buffer. You can either specify the appropriate line number for the line to be recalled, or you can specify a match string. If you use a match string, SMG\$RETURN_INPUT_LINE searches for and returns the line that matches the specified string. This routine aids in the implementation of a DCL-style RECALL command.

The SMG\$REPLACE_INPUT_LINE routine lets you replace the specified line or lines in the recall buffer with the specified string. The remaining lines of the recall buffer are deleted. This routine aids in processing line continuations.

3.8 Interaction of Input and Output

SMG\$READ_COMPOSED_LINE, SMG\$READ_KEYSTROKE, SMG\$READ_STRING, and SMG\$READ_VERIFY accept an optional **display-id** argument. If a **display-id** is supplied, it designates the virtual display in which the input operation should occur. By specifying **display-id**, you enable the Screen Management Facility to remain aware of the changes caused by character echoing. If you omit **display-id**, the Screen Management Facility assumes that screen management output is not being used.

Screen Management Input Operations

3.8 Interaction of Input and Output

Note that if the **display-id** argument is specified for any one of the above-mentioned input routines, then the length of the prompt string plus the input is limited to the number of columns in the display or, where specified, to the maximum number of characters to be read. (In the case of SMG\$READ_KEYSTROKE, this restriction applies only to the length of the prompt string.)

Advanced Screen Management Features

The Screen Management Facility provides several advanced features to:

- Trap asynchronous events
- Create and execute commands in a subprocess
- Move the physical cursor
- Clean up at exit

The following sections describe these features.

Note

The Screen Management Facility assumes that it has complete control of the terminal. Applications should not mix calls to SMG\$ with calls to other screen products such as Compaq GKS or Compaq FMS.

SMG\$ is not reentrant. Therefore, unpredictable results can occur when multiple processes call SMG\$ routines to perform operations on the same terminal. If your application contains multiple processes, one process should call the SMG\$ routines. Other processes should send messages to the calling process when screen modifications are necessary. The calling process can then call the appropriate SMG\$ routines.

4.1 Asynchronous Events

The following types of asynchronous events can disrupt the screen image:

- Broadcast messages
- Unsolicited input
- Out-of-band asynchronous system traps (ASTs)

The following sections explain how to control these actions.

Note

The Screen Management Facility is not AST reentrant. Therefore, the caller of the SMG\$ routines described in this chapter is responsible for any synchronization needed.

Advanced Screen Management Features

4.1 Asynchronous Events

4.1.1 Broadcast Messages

Normally, broadcast messages (for example, MAIL notifications or operator messages) can appear on the terminal screen at any time, destroying or distorting the screen image. The `SMG$SET_BROADCAST_TRAPPING` routine lets you trap messages broadcast to the specified terminal (pasteboard) and in addition, lets you specify an AST routine to be called whenever a broadcast message is trapped. The AST routine you supply can access the broadcast message by calling the `SMG$GET_BROADCAST_MESSAGE` routine.

Whether or not you specify an AST routine in the call to `SMG$SET_BROADCAST_TRAPPING`, you can check for the receipt of a broadcast message at any time by calling `SMG$GET_BROADCAST_MESSAGE`.

4.1.2 Unsolicited Input

The `SMG$ENABLE_UNSOLICITED_INPUT` routine detects the presence of unsolicited input. Note that this routine does not read any input characters; it merely calls an AST routine to notify the application that it should issue a read operation with `SMG$READ_COMPOSED_LINE`, `SMG$READ_KEYSTROKE`, `SMG$READ_STRING`, or `SMG$READ_VERIFY`. It is up to you to read the unsolicited input.

4.1.3 Out-of-Band ASTs

The `SMG$SET_OUT_OF_BAND_ASTS` routine provides a way to trap out-of-band characters such as Ctrl/Y, Ctrl/C, and Ctrl/O. This routine lets you specify which characters are to be treated as out-of-band characters and also lets you specify an AST routine to be called when one of these characters is typed.

4.2 Subprocesses

The Screen Management Facility lets you use a subprocess to execute DCL commands from an application. Only one subprocess is allowed per virtual display.

4.2.1 Creating a Subprocess

The `SMG$CREATE_SUBPROCESS` routine creates a subprocess. This routine creates a DCL subprocess and associates it with a virtual display you specify. The subprocess is initialized with the DCL commands `SET NOVERIFY` and `SET NOON`. The creating process requires an available `BYTLM` value of at least 5000 and an available `PRCLM` value of at least 1. The Screen Management Facility checks to make sure that you have sufficient resources before creating the subprocess.

4.2.2 Deleting a Subprocess

When you are done executing subprocess commands, you can delete the subprocess with the `SMG$DELETE_SUBPROCESS` routine. If you exit without first calling this routine, the Screen Management Facility includes an exit handler that deletes the subprocess for you. It is important to note, however, that under some circumstances these facility-supplied exit handlers are not executed. In that case, you must delete the subprocess with the following commands using your system-assigned process identifier (PID) code for `xxxx`:

```
$ SHOW PROCESS/SUB
$ STOP /IDENT=xxxx
```

4.2.3 Executing Commands in a Subprocess

The `SMG$EXECUTE_COMMAND` routine executes a specified command in the created subprocess. If commands are being buffered, `SMG$EXECUTE_COMMAND` returns control after the specified command is buffered. The `AST` routine that you specify is invoked with the command status when the command completes execution. If commands are not being buffered, `SMG$EXECUTE_COMMAND` waits until the command has completed execution before returning the status of the command.

When you specify the command string to be executed, you must specify a dollar sign (\$) as the first character of any DCL command. The Screen Management Facility assumes that any command string that does not begin with a dollar sign is input data for the previous command. The commands and their outputs are displayed on the specified virtual display as they are executed. Note that the commands `SPAWN`, `GOTO`, and `LOGOUT` are illegal to use as command strings and generate unpredictable results.

It is also important to note that since I/O is performed by means of mailboxes and not through the terminal driver, single-character commands such as `Ctrl/C`, `Ctrl/Y`, `Ctrl/Z`, and so on have no effect. Use `SMG$M_SEND_EOF` as the **flags** parameter in order to pass a `Ctrl/Z` to the subprocess.

4.3 Moving the Cursor

The Screen Management Facility lets you move the cursor to a specified location on the physical screen. It does so through the `SMG$SET_PHYSICAL_CURSOR` routine. However, if you attempt to move the cursor to a pasteboard position outside the screen boundaries, an error is returned.

4.4 Exit Handler

The Screen Management Facility supplies an exit handler, which is invoked before image termination. This handler deletes all pasteboards and virtual keyboards associated with the current image and resets the terminal characteristics. The Screen Management Facility's exit handler may or may not be invoked before any user-supplied exit handlers. Therefore, you should not delete pasteboards or virtual displays from inside a user-supplied exit handler because they may already have been deleted by the Screen Management Facility exit handler and their identifiers deassigned.

Support for Third-Party Terminals

This chapter describes SMG\$ support for *foreign* terminals. A foreign terminal is any terminal for which the device type is not one of the Compaq terminals recognized by OpenVMS, or any terminal on which the ANSI_CRT characteristic is not set.

This support is used by the Screen Management Facility, but it can also be used by application programs that perform their own I/O to foreign terminals. Thus, if you use the Screen Management Facility, you need to concern yourself only with the definition of foreign terminal capabilities, and not with the details of calling the foreign terminal routines directly. Further, you need to define only a few terminal capabilities (“set absolute cursor position,” “erase to end of display,” and “erase to end of line”) in order for the Screen Management Facility to effectively control the terminal screen. The routines used by the Screen Management Facility are presented here to allow you to do your own I/O to foreign terminals.

The support begins with a source file named TERMTABLE.TXT, which contains a list of terminal names and their associated capabilities. This file is processed by the SYSSYSTEM:SMGBLDTRM.EXE program to create an image file called TERMTABLE.EXE. The following sections describe the creation and processing of the TERMTABLE database.

Note that the TERMTABLE support is used by the Screen Management Facility for all terminals, including Compaq terminals. The definitions for Compaq terminals are included in a file named SYSSYSTEM:SMGTERMS.TXT, which is provided as part of the Screen Management Facility. The examples in this chapter show you how to use the foreign terminal package to define Compaq terminals, because most users are familiar with them.

Note

You should not create your own definitions for Compaq terminals, nor should you modify the definitions in SYSSYSTEM:SMGTERMS.TXT.

5.1 TERMTABLE Interface Routines

TERMTABLE.EXE is a database containing information about any number of different types of terminals. You extract information from this database with these steps:

1. Provide the terminal name to the database.
2. Retrieve the information about that terminal type (this step might be repeated any number of times).
3. End access to the database.

Support for Third-Party Terminals

5.1 TERMTABLE Interface Routines

When using screen management routines to perform I/O to foreign terminals, you need only create the proper TERMTABLE entries for the foreign terminals you use. The steps listed above are necessary only when your program performs I/O directly to foreign terminals.

The first step can be performed in either of two ways. You can either pass a string that contains a terminal name (for example, "VT100") to the SMG\$INIT_TERM_TABLE routine, or you can pass a value returned by the OpenVMS system service \$GETDVI to the SMG\$INIT_TERM_TABLE_BY_TYPE routine. The returned value may be a symbolic terminal type (for example, TT\$_VT100 or TT\$_VT52) or a value assigned by the SMG\$ foreign terminal routines to designate a particular foreign terminal.

The second step requires that you call the SMG\$GET_TERM_DATA routine. This routine extracts a command string (for example, an escape sequence) from TERMTABLE and stores it in a buffer you provide. It is then your responsibility to write the command string to the terminal. It may be necessary to call SMG\$GET_TERM_DATA many times; each time you receive the command sequence you can perform a different operation. You should also call SMG\$GET_TERM_DATA each time you want to use a capability string that requires a substitution or arithmetic operation for an argument. However, you may want to save the static capability strings in your program's local storage. These static capability strings can be retrieved once and used any number of times.

The third step is optional; it merely frees the virtual memory used to access the information in the database.

The DCL commands SET and SHOW TERMINAL recognize any name defined in TERMTABLE, as well as the current set of valid OpenVMS terminal names. If you use the SET TERMINAL/DEVICE=name command to specify a terminal that is unknown to the OpenVMS operating system, the TERMTABLE database is searched for the named terminal.

Two routines are provided to obtain the address of a specific terminal definition. SMG\$INIT_TERM_TABLE accepts a terminal name as input; SMG\$INIT_TERM_TABLE_BY_TYPE accepts a device type as input. Each maps to a specific terminal entry in the TERMTABLE.EXE section. These routines return this identifier to the caller for use in future calls.

SMG\$GET_TERM_DATA accepts the identifier of the compiled TERMTABLE database and a request code. The request code is used as an index into the data to retrieve the appropriate escape sequence. Some sequences are static; they do not contain any variable information and are simply copied into the caller's buffer. Variable sequences, which include a ! or % directive, cause additional processing to take place. An example of a variable sequence is the VT300-series set cursor command: the required binary row and column numbers must be converted to ASCII for the set cursor sequence. SMG\$GET_TERM_DATA uses the optional input arguments to do the conversion before copying the sequence to the caller's buffer.

If you do not provide any optional input arguments to SMG\$GET_TERM_DATA, it uses a default of 1 for each argument that the capability requires. Nevertheless, you cannot supply some of the optional arguments and accept the default for others—you must supply all or none of them. SMG\$GET_NUMERIC_DATA provides a simplified interface for users who wish to obtain numeric or Boolean data only.

When all terminal I/O has been completed, `SMG$DEL_TERM_TABLE` can be called to release the virtual memory used. This routine is useful only if you do not need `TERMTABLE` for the duration of your program; releasing virtual memory may make it available for reuse by your program.

A skeleton `TERMTABLE.TXT` is supplied in `SYSS$SYSTEM:.` `SMGTERMS.TXT`, which defines Compaq terminals, is also provided. The skeleton `TERMTABLE.TXT` uses the `REQUIRE` directive to include the separate source file `SMGTERMS.TXT`. Thus, only third-party terminals are actually defined in the `TERMTABLE.TXT` source file.

5.2 Capability Fields

If you have a foreign (third-party) terminal, the Screen Management Facility does not know what your terminal can and cannot do—in other words, what the terminal's capabilities are. Capability fields let you tell the Screen Management Facility what capabilities are supported for your foreign terminal. These fields let `SMG$` use your terminal capabilities rather than emulate common terminal functions, which in turn improves `SMG$`'s performance.

Three types of capability fields are allowed in a `TERMTABLE` entry:

- Boolean
- Numeric
- String

The following sections describe these capability fields in detail.

Functions that are common to most terminals have been chosen as possible fields; not all functions of all terminal types are represented. (Specifically, there is no support for block mode, graphics, or typesetting composition functions.) Screen-oriented applications should be planned around typical terminal functions, and should not depend on features that exist on only one or a few models.

For applications that must support an unusual terminal, some generic capability names are reserved for user definition. Names of the form `PRIVATE_BOO_n`, `PRIVATE_NUM_n`, and `PRIVATE_STR_n`, where *n* is a number from 1 to 10, may be included as user-defined terminal definitions and returned by the `TERMTABLE` interface routines. Since meanings are assigned by the user, private capabilities vary between applications. Sites running several applications must guard against multiple definitions for a single private capability. (For example, you should include separate terminal entries for a terminal that requires `PRIVATE_STR_1` to mean two different things, depending on the application program being run.) In general, you should not have to use private capabilities.

The following characters are used as delimiters in capability fields:

| Delimiter | Meaning |
|-----------|--|
| ! | Begins a comment |
| = | Separates a capability field name from its value |
| , | Separates capability fields |
| " | Delimits strings |

Support for Third-Party Terminals

5.2 Capability Fields

5.2.1 Boolean Capability Fields

Boolean capabilities are either present or not present for a given terminal.

The format for a Boolean capability field is as follows:

BOOLEAN {Boolean-capability = binary-digit} [...]

Following are the meanings of the elements:

- Boolean-capability — One of the capability fields listed in Table 5–1
- Binary-digit — Either 1 or 0

Table 5–1 Boolean Capabilities

| Capability Field | Used by SMG | Meaning if Set |
|---------------------|-------------|--|
| ADVANCED_VIDEO | N | The terminal has advanced video attributes and is capable of 132-column mode operation. |
| ANSI_COLOR | N | Terminal conforms to ANSI color programming standards. |
| ANSI_CRT | N | Terminal conforms to ANSI CRT programming standards. |
| AUTO_MARGIN | N | Terminal has automatic margins. |
| BACKSPACE | Y | Terminal can backspace with Ctrl/H. |
| BLOCK_MODE | N | Terminal can perform block mode transmission, local editing, and field protection. |
| CURSOR_REPORT_ANSI | N | Terminal uses the ANSI sequence to report the current cursor location. |
| DEC_CRT | N | Terminal conforms to Compaq VT100 family standards. |
| DEC_CRT_2 | N | Terminal conforms to Compaq VT200 family standards. |
| DEC_CRT_3 | N | Terminal conforms to Compaq VT300 family standards. |
| DEC_CRT_4 | N | Terminal conforms to Compaq VT400 family standards. |
| DEC_CRT_5 | N | Terminal conforms to Compaq VT500 family standards. |
| EDIT | N | Terminal can perform ANSI-defined advanced editing functions. |
| EIGHT_BIT | N | Terminal uses 8-bit ASCII character code. |
| FULLDUP | N | Terminal operation mode is full-duplex (half-duplex if not set). |
| IGNORE_NEWLINE | N | Terminal ignores a newline after a wrap. |
| INSERT_MODE_NULLS | N | Insert mode distinguishes nulls on display. |
| LOWERCASE | N | Terminal has both uppercase and lowercase letters. |
| NO_ERASE | N | Standout (bolded) characters are not erased by writing over them. |
| NO_SCROLL | N | Terminal is not capable of scrolling. |
| OVERSTRIKE | N | Terminal is capable of overstriking. |
| PHYSICAL_FF | N | Terminal can accept form feeds (if not set, terminal driver must translate form feeds to multiple line feeds). |
| PHYSICAL_TABS | N | Terminal has hardware tabs (note that these tabs may need to be set with an initialization string). |
| PRINTER_PORT | N | Terminal has a printer port available. |
| PRIVATE_BOO_1 to 10 | N | These fields denote user-defined capabilities 1 through 10. |

(continued on next page)

Table 5–1 (Cont.) Boolean Capabilities

| Capability Field | Used by SMG | Meaning if Set |
|--------------------|----------------|--|
| REGIS | N | Terminal understands ReGIS graphics commands. |
| SCOPE | N | Terminal is a video terminal. |
| SET_CURSOR_COL_ROW | Y | Terminal uses column/row addressing. |
| SIXEL_GRAPHICS | N | Terminal can display graphics using the ReGIS-defined SIXEL graphics protocol. |
| SOFT_CHARACTERS | N | Terminal can load a user-defined character set. |
| UNDERLINE | N | Terminal has underlining capability (but not overstrike). |

For example, the following TERMTABLE entry describes two characteristics of a VT300 series terminal:

```
NAME = "VT300_series"
BOOLEAN
ansi_crt = 1,          dec_crt = 1
```

This entry specifies that the terminal conforms to ANSI CRT programming standards and to Compaq VT300 series standards.

5.2.2 Numeric Capability Fields

Numeric capabilities take a numeric argument; for example, the number of columns on the terminal screen.

The format for a numeric capability field is as follows:

```
NUMERIC {numeric-capability = value} [...]
```

Following are the meanings of the elements:

- **Numeric-capability**—One of the capability fields listed in Table 5–2
- **Value**—The value for the specified numeric capability

Table 5–2 Numeric Capabilities

| OpenVMS Name | Used by SMG | Description |
|---------------------|----------------|--|
| COLUMNS | Y | Specifies the number of columns in a line. |
| CR_FILL | N | Specifies the number of fill characters needed after a carriage return. |
| LF_FILL | N | Specifies the number of fill characters needed after a line feed. |
| FRAME | N | Controls the number of data bits expected by the terminal driver for every character that is input or output (value must be between 5 and 8, inclusive). |
| NUMBER_FN_KEYS | N | Specifies the number of function keys available. |
| PRIVATE_NUM_1 to 10 | N | If set, these fields denote user-defined capabilities 1 through 10. |
| ROWS | N | Specifies the number of rows on the screen. |

(continued on next page)

Support for Third-Party Terminals

5.2 Capability Fields

Table 5–2 (Cont.) Numeric Capabilities

| OpenVMS Name | Used by SMG | Description |
|---------------------|-------------|---|
| WIDE_SCREEN_COLUMNS | Y | Specifies the number of columns available in wide mode. |

For example, the following TERMTABLE entry describes two characteristics of a VT300-series terminal:

```
NAME = "VT300_series"  
NUMERIC  
    rows = 24,          columns = 80
```

5.2.3 String Capability Fields

String capability fields provide several features. They let you do the following:

- Supply alternate characters for line drawing
- Provide icons so that your program can display carriage control characters (for example, form feeds) instead of executing them
- Supply the character sequences that cause a given operation (for example, ERASE_TO_END_OF_LINE) to be performed on any type of terminal
- Specify the character strings returned by special keys (for example, function keys) on a given terminal
- Specify strings having a maximum length of 255 characters (the maximum length of a string depends on its complexity, but in no case can it be longer than 255)

Table 5–3 lists string capabilities.

Support for Third-Party Terminals 5.2 Capability Fields

Table 5–3 String Capabilities

| OpenVMS Name | Used by SMG | Description |
|-------------------------|-------------------|---|
| BEGIN_ALTERNATE_CHAR | N | Begins alternate character set. |
| BEGIN_AUTOPRINT_MODE | N | Begins autoprint mode. |
| BEGIN_AUTOREPEAT_MODE | N | Begins autorepeat mode. |
| BEGIN_AUTOWRAP_MODE | N | Begins autowrap mode. |
| BEGIN_BLINK | Y | Begins blinking characters. |
| BEGIN_BOLD | Y | Begins bolded characters. |
| BEGIN_DELETE_MODE | N | Begins delete mode. |
| BEGIN_INSERT_MODE | N | Begins insert mode. |
| BEGIN_LINE_DRAWING_CHAR | Y | Begins using line-drawing character set. |
| BEGIN_NORMAL_RENDITION | Y | Begins using normal video attributes. |
| BEGIN_REVERSE | Y | Begins reverse video characters. |
| BEGIN_UNDERSCORE | Y | Begins underscored characters. |
| BOTTOM_T_CHAR | Y | Displays line-drawing character <i>bottom t</i> . |
| CLEAR_TAB | N | Clears tab at current column. |
| CR_GRAPHIC | Y | Defines character to indicate a carriage return when control characters are being represented rather than executed. |
| CROSS_CHAR | Y | Defines character to represent the intersection of perpendicular lines. |
| CURSOR_DOWN | N | Moves cursor <i>n</i> lines down (does not cause scrolling). |
| CURSOR_LEFT | N | Moves cursor <i>n</i> positions to the left. |
| CURSOR_NEXT_LINE | N | Accepts an argument <i>n</i> and moves the cursor to the first position in the <i>n</i> th following line. |
| CURSOR_POSITION_REPORT | N | Reports the active position using two arguments. |
| CURSOR_PRECEDING_LINE | N | Accepts an argument <i>n</i> and moves the cursor to the first position in the <i>n</i> th preceding line. |
| CURSOR_RIGHT | N | Accepts an argument <i>n</i> and moves the cursor <i>n</i> positions to the right. |
| CURSOR_UP | N | Accepts an argument <i>n</i> and moves cursor up <i>n</i> lines (does not cause scrolling). |
| DARK_SCREEN | Y | Makes screen background color dark (normal video). |
| DELETE_CHAR | N | Accepts an argument <i>n</i> and deletes <i>n</i> characters. |
| DELETE_LINE | N | Accepts an argument <i>n</i> and deletes <i>n</i> lines. |
| DEVICE_ATTRIBUTES | N | Terminal's response to a "What are you?" sequence. |
| DOUBLE_HIGH_BOTTOM | Y | Changes line to double height bottom half. |
| DOUBLE_HIGH_TOP | Y | Changes line to double height top half. |

(continued on next page)

Support for Third-Party Terminals

5.2 Capability Fields

Table 5–3 (Cont.) String Capabilities

| OpenVMS Name | Used by SMG | Description |
|-------------------------|-------------|--|
| DOUBLE_WIDE | Y | Changes line to double width. |
| END_ALTERNATE_CHAR | N | Ends alternate character set. |
| END_AUTOPRINT_MODE | N | Ends autoprint mode. |
| END_AUTOREPEAT_MODE | N | Ends autorepeat mode. |
| END_AUTOWRAP_MODE | N | Ends autowrap mode. |
| END_BLINK | N | Ends blinking characters. |
| END_BOLD | N | Ends bolding mode. |
| END_DELETE_MODE | N | Ends delete mode. |
| END_INSERT_MODE | N | Ends insert mode. |
| END_LINE_DRAWING_CHAR | Y | Ends line-drawing characters. |
| END_REVERSE | N | Ends reverse video characters. |
| END_UNDERSCORE | N | Ends underscore. |
| ERASE_DISPLAY_TO_CURSOR | N | Erases display to virtual cursor position. |
| ERASE_LINE_TO_CURSOR | N | Erases line to virtual cursor position. |
| ERASE_TO_END_DISPLAY | N | Erases to end of display. |
| ERASE_TO_END_LINE | Y | Erases to end of line. |
| ERASE_WHOLE_DISPLAY | Y | Erases whole display. |
| ERASE_WHOLE_LINE | N | Erases whole line. |
| ERROR_ICON | Y | Defines character that indicates an error. |
| FF_GRAPHIC | Y | Uses this character to indicate a form feed when control characters are displayed rather than executed. |
| HOME | Y | Defines home cursor. |
| HORIZONTAL_BAR | Y | Displays line-drawing character <i>horizontal bar</i> . |
| HT_GRAPHIC | Y | Uses this character to indicate a horizontal tab when control characters are displayed rather than executed. |
| INDEX | N | Moves the cursor down one line without changing the column position (contents of the screen scroll up if necessary). |
| INIT_STRING | Y | Defines terminal initialization string. |
| INSERT_CHAR | N | Accepts an argument <i>n</i> and inserts <i>n</i> characters. |
| INSERT_LINE | N | Accepts an argument <i>n</i> and inserts <i>n</i> lines. |
| INSERT_PAD | N | Accepts an argument <i>n</i> and inserts <i>n</i> pad characters after character inserted. |
| KEY_0 | Y | Returned by keypad 0 in applications mode. |
| KEY_1 | Y | Returned by keypad 1 in applications mode. |

(continued on next page)

Table 5–3 (Cont.) String Capabilities

| OpenVMS Name | Used by SMG | Description |
|-----------------|-------------------|---|
| KEY_2 | Y | Returned by keypad 2 in applications mode. |
| KEY_3 | Y | Returned by keypad 3 in applications mode. |
| KEY_4 | Y | Returned by keypad 4 in applications mode. |
| KEY_5 | Y | Returned by keypad 5 in applications mode. |
| KEY_6 | Y | Returned by keypad 6 in applications mode. |
| KEY_7 | Y | Returned by keypad 7 in applications mode. |
| KEY_8 | Y | Returned by keypad 8 in applications mode. |
| KEY_9 | Y | Returned by keypad 9 in applications mode. |
| KEY_BACKSPACE | N | Returned by backspace key. |
| KEY_COMMA | Y | Returned by keypad comma key. |
| KEY_DOWN_ARROW | Y | Returned by down arrow key. |
| KEY_E1 | Y | Returned by E1 (editing key 1). |
| KEY_E2 | Y | Returned by E2 (editing key 2). |
| KEY_E3 | Y | Returned by E3 (editing key 3). |
| KEY_E4 | Y | Returned by E4 (editing key 4). |
| KEY_E5 | Y | Returned by E5 (editing key 5). |
| KEY_E6 | Y | Returned by E6 (editing key 6). |
| KEY_ENTER (k) | Y | Returned by keypad enter key. |
| KEY_F1 | Y | Returned by F1 (function key 1). |
| . | | . |
| . | | . |
| . | | . |
| KEY_F20 | Y | Returned by F20 (function key 20). |
| KEY_LABEL_F1 | N | Legend on F1 (function key 1). |
| . | | . |
| . | | . |
| . | | . |
| KEY_LABEL_F20 | N | Legend on F20 (function key 20). |
| KEY_LEFT_ARROW | Y | Returned by left arrow key. |
| KEY_MINUS | Y | Returned by keypad minus key. |
| KEY_PERIOD | Y | Returned by keypad period key. |
| KEY_PF1 | Y | Returned by PF1 key. |
| KEY_PF2 | Y | Returned by PF2 key. |
| KEY_PF3 | Y | Returned by PF3 key. |
| KEY_PF4 | Y | Returned by PF4 key. |
| KEY_RIGHT_ARROW | Y | Returned by right arrow key. |
| KEY_UP_ARROW | Y | Returned by up arrow key. |
| LEFT_T_CHAR | Y | Displays line-drawing character <i>left t</i> . |

(continued on next page)

Support for Third-Party Terminals

5.2 Capability Fields

Table 5–3 (Cont.) String Capabilities

| OpenVMS Name | Used by SMG | Description |
|--------------------------|-------------|--|
| LF_GRAPHIC | Y | Uses this character to indicate a line feed when control characters are displayed rather than executed. |
| LIGHT_SCREEN | Y | Makes screen background color light (reverse video). |
| LOWER_LEFT_CORNER | Y | Displays line-drawing character <i>lower left corner</i> . |
| LOWER_RIGHT_CORNER | Y | Displays line-drawing character <i>lower right corner</i> . |
| NAME | Y | Defines terminal name; must be the first field in the entry. |
| NEWLINE_CHAR | N | Defines new-line character. |
| NEXT_LINE | N | Displays next line. |
| NO_PRINTER | N | Defines no attached printer status. |
| PAD_CHAR | N | Defines pad character (if other than null). |
| PRINT_SCREEN | N | Prints contents of screen. |
| PRINTER_READY | N | Defines printer ready status. |
| PRINTER_NOT_READY | N | Defines printer not ready status. |
| PRIVATE_STR_1 | N | User-defined capability 1. |
| . | . | . |
| . | . | . |
| PRIVATE_STR_10 | N | User-defined capability 10. |
| REQUEST_CURSOR_POSITION | N | Requests the active cursor position. |
| REQUEST_PRINTER_STATUS | N | Requests status of attached printer. |
| RESTORE_CURSOR | N | Restores cursor to previously saved position. |
| REVERSE_INDEX | N | Moves the cursor to the same column on the preceding line (contents of the screen scroll down if necessary). |
| RIGHT_T_CHAR | Y | Displays line-drawing character <i>right t</i> . |
| SAVE_CURSOR | N | Saves cursor position. |
| SCROLL_FORWARD | N | Accepts an argument <i>n</i> and scrolls forward <i>n</i> lines. |
| SCROLL_REVERSE | Y | Accepts an argument <i>n</i> and scrolls backward <i>n</i> lines. |
| SEL_ERASE_TO_END_DISPLAY | N | Selectively erases from cursor to end of display (does not change attributes). |
| SEL_ERASE_TO_END_LINE | N | Selectively erases from cursor to end of line (does not change attributes). |
| SEL_ERASE_WHOLE_DISPLAY | N | Selectively erases entire display (does not change attributes). |

(continued on next page)

Support for Third-Party Terminals 5.2 Capability Fields

Table 5–3 (Cont.) String Capabilities

| OpenVMS Name | Used by SMG | Description |
|------------------------|-------------------|--|
| SEL_ERASE_WHOLE_LINE | N | Selectively erases entire line (does not change attributes). |
| SET_APPLICATION_KEYPAD | Y | Begins applications keypad mode. |
| SET_CHAR_NOT_SEL_ERASE | N | Designates all subsequent characters as not selectively erasable. |
| SET_CHAR_SEL_ERASE | N | Designates all subsequent characters as selectively erasable. |
| SET_CURSOR_ABS | Y | Directs cursor addressing (accepts row and column arguments). |
| SET_CURSOR_OFF | Y | Sets cursor to invisible. |
| SET_CURSOR_ON | Y | Sets cursor to visible. |
| SET_JUMP_SCROLL | Y | Sets scrolling to jump scroll. |
| SET_NUMERIC_KEYPAD | Y | Ends keypad applications mode (resumes numeric mode). |
| SET_ORIGIN_ABSOLUTE | N | Allows cursor positioning outside current scrolling region. |
| SET_ORIGIN_RELATIVE | N | Prohibits cursor positioning outside current scrolling region. |
| SET_PRINTER_OUTPUT | N | Sends output to printer port rather than screen. |
| SET_SCREEN_OUTPUT | N | Sends output to terminal screen. |
| SET_SCROLL_REGION | Y | Sets scrolling region (accepts as arguments top margin and bottom margin). |
| SET_SMOOTH_SCROLL | Y | Sets scrolling to smooth scroll. |
| SET_TAB | N | Sets tab at current column. |
| SINGLE_HIGH | Y | Changes this line to single height, single width. |
| TAB_CHAR | N | Defines tab character (other than Ctrl/I or tab with padding); note that this field should be used only for non-ASCII terminals. |
| TOP_T_CHAR | Y | Displays line-drawing character <i>top t</i> . |
| TRUNCATION_ICON | Y | Defines the character that indicates overflow characters were truncated. |
| UNDERLINE_CHAR | N | Underlines a character. |
| UPPER_LEFT_CORNER | Y | Displays line-drawing character <i>upper left corner</i> . |
| UPPER_RIGHT_CORNER | Y | Displays line-drawing character <i>upper right corner</i> . |
| VERTICAL_BAR | Y | Displays line-drawing character <i>vertical bar</i> . |

(continued on next page)

Support for Third-Party Terminals

5.2 Capability Fields

Table 5–3 (Cont.) String Capabilities

| OpenVMS Name | Used by SMG | Description |
|--------------|-------------|---|
| VT_GRAPHIC | Y | Defines the character that indicates a vertical tab when control characters are displayed rather than executed. |
| WIDTH_NARROW | Y | Sets terminal width to narrow (usually 80 columns). |
| WIDTH_WIDE | Y | Sets terminal width to wide (usually 132 columns). |

Table 5–4 lists the STRING_2 capabilities. In order to construct one of the user-defined renditions SMG\$M_USER1 through SMG\$M_USER8, you must provide an appropriate definition in the file TERMTABLE.TXT using STRING_2 capabilities.

Table 5–4 String_2 Capabilities

| OpenVMS Name | Used by SMG | Description |
|-------------------|-------------|--|
| BEGIN_STATUS_LINE | Y | Begins output to hardware status line. |
| BEGIN_USER1 | Y | Begins first user-defined attribute. |
| BEGIN_USER2 | Y | Begins second user-defined attribute. |
| BEGIN_USER3 | Y | Begins third user-defined attribute. |
| BEGIN_USER4 | Y | Begins fourth user-defined attribute. |
| BEGIN_USER5 | Y | Begins fifth user-defined attribute. |
| BEGIN_USER6 | Y | Begins sixth user-defined attribute. |
| BEGIN_USER7 | Y | Begins seventh user-defined attribute. |
| BEGIN_USER8 | Y | Begins eighth user-defined attribute. |
| END_STATUS_LINE | Y | Ends output to hardware status line. |
| END_USER1 | N | Ends first user-defined attribute. |
| END_USER2 | N | Ends second user-defined attribute. |
| END_USER3 | N | Ends third user-defined attribute. |
| END_USER4 | N | Ends fourth user-defined attribute. |
| END_USER5 | N | Ends fifth user-defined attribute. |
| END_USER6 | N | Ends sixth user-defined attribute. |
| END_USER7 | N | Ends seventh user-defined attribute. |
| END_USER8 | N | Ends eighth user-defined attribute. |
| BLACK_SCREEN | Y | Makes screen background color black. |
| BLUE_SCREEN | Y | Makes screen background color blue. |
| CYAN_SCREEN | Y | Makes screen background color cyan (green-blue). |

(continued on next page)

Table 5–4 (Cont.) String_2 Capabilities

| OpenVMS Name | Used by SMG | Description |
|----------------|-------------------|--|
| GREEN_SCREEN | Y | Makes screen background color green. |
| MAGENTA_SCREEN | Y | Makes screen background color magenta. |
| RED_SCREEN | Y | Makes screen background color red. |
| WHITE_SCREEN | Y | Makes screen background color white. |
| YELLOW_SCREEN | Y | Makes screen background color yellow. |
| USER1_SCREEN | Y | User-defined background color. |
| USER2_SCREEN | Y | User-defined background color. |

Because string capability fields often include nonprinting characters, the following substitutions are used to make it easy to insert these characters in a capability string. Use the special character to represent the nonprinting character.

| Special Character | Nonprinting Character | Meaning |
|-------------------|-----------------------|-------------------------|
| \$ | ESCAPE | ASCII decimal value 27 |
| ^ | CONTROL | Control |
| & | CSI | ASCII decimal value 155 |
| @ | SS3 | ASCII decimal value 143 |

Thus to create a capability string that contains an escape character, you insert a dollar sign at that position. To create a capability string that contains a control character, prefix the character with a circumflex (^). For example:

```
NAME = "VT300_series"
.
.
.
  STRING
    begin_alternate_char = "^N",
    end_alternate_char = "^O",
    erase_whole_display = "$[2J"
.
.
.
END
```

If you want to use a character in a capability string with its normal ASCII value, place an underscore in front of it. (For example, “_ \$” results in a single dollar sign rather than an underscore followed by an escape character). The following characters must be preceded by an underscore in order to be treated as normal ASCII text:

| | |
|------------|---|
| Ampersand | & |
| Apostrophe | ' |
| At sign | @ |

Support for Third-Party Terminals

5.2 Capability Fields

| | |
|-------------------|----|
| Quotation marks | " |
| Circumflex | ^ |
| Dollar sign | \$ |
| Exclamation point | ! |
| Left parenthesis | (|
| Underscore | _ |

The Screen Management Facility automatically invokes the graphics mode needed to display the line-drawing character set (for example, the *bottom_t_char*, *top_t_char*, and so on). However, if you call the foreign terminal routines directly, you are responsible for invoking the required graphics mode.

Padding (for example, with null characters) must sometimes be added to a terminal command to allow the terminal sufficient time to execute the command. The amount of padding needed depends on the terminal and the baud rate. The pad character capability field is included only for future expansion and has no function in this release; padding is the responsibility of the user.

When the foreign terminal support routines are called directly, many of the string capability fields use arguments whose values must be specified at run time. Further, some arguments also require that arithmetic operations be performed when values are substituted for arguments. The following sections describe argument substitution and arithmetic operations.

5.2.4 Argument Substitution

It is frequently necessary to substitute values in a terminal command string. For example, setting a scrolling region or moving the cursor ten columns to the right requires the run-time substitution of a value; these values cannot be stored in the TERMTABLE terminal definition. TERMTABLE provides for string substitution by accepting !UL, an \$FAO style directive. The !UL directive signifies that a value is to be inserted at that point: the TERMTABLE interface routine is to accept an unsigned longword and convert it to ASCII digits before substituting it in the capability field string (and thus in the returned command string). For example:

```
NAME = "VT300_series"
.
.
.
STRING
set_cursor_abs = "$[!UL;!ULH"
.
.
.
END
```

The string defined for the SET_CURSOR_ABS function must have values substituted for the two !UL directives; these values specify the row and column number at which to set the cursor. You specify these run-time arguments as an optional longword vector argument to the SMG\$GET_TERM_DATA routine. The first entry in the vector contains the number of arguments that follow. Thus, the first entry is 2, the second entry is the desired row number, and the third entry is the desired column number. The SMG\$GET_TERM_DATA routine converts the first optional data item (the second item in the vector) to ASCII digits and

substitutes an ASCII value for the first !UL directive; it converts the second optional data item and substitutes it for the second !UL directive, and so on.

5.2.5 Arithmetic Operations

In addition to argument substitution, terminal command sequences may also require arithmetic operations. To perform an argument substitution and arithmetic operation, the TERMTABLE entry requires a different scheme than for argument conversion and substitution.

To perform both argument substitution and arithmetic operations, you use an opening parenthesis, a percent sign (to indicate the point of substitution), an arithmetic operator, an operand, and a closing parenthesis. For example:

```
NAME = "VT52"
.
.
.
STRING
set_cursor_abs = "$Y(%1+31)(%2+31)"
.
.
.
END
```

This example shows the string that directly positions the cursor on a VT52, where a bias must be added to the row and column numbers. Values to be substituted in the expression are passed with the SMG\$GET_TERM_DATA routine, in the same way as for argument substitution alone. The percent sign is always followed by an integer that indicates the order in which arguments should be substituted.

The following table summarizes the characters used in arithmetic operations:

| Character | Meaning |
|------------|--------------------------------------|
| (| Beginning of arithmetic expression |
| % <i>n</i> | Substitute <i>n</i> th user argument |
| + | Arithmetic addition operator |
| - | Arithmetic subtraction operator |
| * | Arithmetic multiplication operator |
| / | Arithmetic division operator |
|) | End of arithmetic expression |

Longword integers are sufficient to express screen coordinates. Expressions are evaluated from left to right; there is no operator precedence.

Spaces between items are not significant; they may be used wherever desired to improve readability. Capability strings are limited to 128 bytes in length.

Support for Third-Party Terminals

5.3 Creating an OpenVMS Terminal Capabilities File

5.3 Creating an OpenVMS Terminal Capabilities File

The source code for the database is an ASCII file named TERMTABLE.TXT. This file contains an entry for each type of terminal. Each entry lists a terminal's capabilities and other device-specific information, such as initialization sequences and screen size; a TERMTABLE entry can span more than one record in the file. A terminal definition can be added by editing the TERMTABLE.TXT file; TERMTABLE.TXT must then be reprocessed by running SYSSYSTEM:SMGBLDTRM.EXE.

TERMTABLE.TXT can be created with any text editor. A TERMTABLE entry consists of a terminal name, followed by any number of capability fields and their values (see Section 5.2 for more information about capability fields). Although TERMTABLE.TXT must be formatted for compilation, capability names are descriptive and can be easily understood. Terminal names must be unique; for example, if more than one definition is needed for a foreign terminal, then a second name must be used.

When a TERMTABLE routine first searches for a terminal entry, it tries to find TERMTABLE.EXE in the area logically named TERMSTABLOC. If the specified terminal entry is not found there, the routine then searches for TERMTABLE.EXE in SYSSYSTEM. If you want to use a terminal definition that differs from the system definition for that terminal, you can create a private copy of TERMTABLE.TXT and TERMTABLE.EXE. You can then define a single terminal with a definition that is different from the one in SYSSYSTEM:TERMTABLE.EXE and still use the rest of the standard system definitions.

The format of a TERMTABLE entry is as follows:

```
NAME = "terminal-name" capability-field [... ] END
```

The TERMTABLE.TXT file allows you to include REQUIRE directives. The REQUIRE directive lets you include separate source files in the TERMTABLE.TXT file. Its format is as follows:

```
REQUIRE "filespec"
```

In the above format, "filespec" is a valid OpenVMS file specification.

5.4 Examples

The following example contains sample terminal definitions for the TERMTABLE.TXT file; these entries contain device-specific information for a VT300 terminal and a VT52 terminal.

```
!  
!      Private versions of Compaq terminal definitions  
!  
NAME = 'myvt300'  
  
  BOOLEAN  
  ansi_crt = 1,          dec_crt = 1  
  
  NUMERIC  
  rows = 24,            columns = 80,  
  wide_screen_columns = 132
```

Support for Third-Party Terminals 5.4 Examples

```
STRING
begin_alternate_char = "^N",
end_alternate_char = "^O",
erase_whole_display = "${2J",
init_string = "$_(B",
set_cursor_abs = "${!UL;!ULH"
END
NAME = "MYVT52"

BOOLEAN
ansi_crt = 0,          dec_crt = 1

NUMERIC
rows = 24,             columns = 80,
wide_screen_columns = 80

STRING
begin_alternate_char = "$F"
end_alternate_char = "$G",
erase_whole_display = "$Y(32)(32)$J", !position to 1,1; then erase
set_cursor_abs = "$Y(%1+31)(%2+31)"
END
```

For the set cursor sequence listed for a VT300 series (MYVT300), the string returned depends on the values provided in the argument vector supplied with the call to the SMG\$GET_TERM_DATA routine. For example, to position the cursor to row 3 and column 12, you supply these longword values as the second and third entries in the vector (the first entry is the number of values that follow). The SMG\$GET_TERM_DATA routine converts these longword values into their ASCII values and inserts the converted values into the string returned at the point of the respective !UL directives.

For the set cursor sequence listed for a VT52 (MYVT52), the string returned depends not on argument substitution, but on an arithmetic operation (because the VT52 requires biasing). The arithmetic operator is used to add 31 (decimal) to the row and column numbers supplied in entries 2 and 3 of the argument vector for the SMG\$GET_TERM_DATA routine.

The INIT_STRING field in MYVT300 is included to point out that the parenthesis is normally treated as a special character indicating an arithmetic expression. A parenthesis must be preceded by an underscore in order to be interpreted as a normal text character. Thus the string "\$_(B" yields ESC(B, a command that designates the ASCII character set into G0.

The ERASE_WHOLE_DISPLAY sequence for MYVT52 shows that it may be necessary to combine sequences in order to provide a certain function. The VT52 does not have a command that erases the entire screen. However, you can erase the entire screen by homing the cursor and then using the command that erases from the current position to the end of the screen.

The following BASIC example program uses the LIB\$GETDVI routine to ascertain the type of terminal associated with SYSS\$OUTPUT. The program then uses the foreign terminal routines to place the cursor at the twelfth screen line and to erase to the end of the screen. The program detects whether these capabilities are available for the terminal and displays an error message if they are not.

Support for Third-Party Terminals

5.4 Examples

```

10 ! Program to call the Termttable interface routines
!
! This program sets the cursor to row 12 column 1,
! and erase to the bottom of the screen.  If the cursor
! positioning or erasing to the end of the screen
! capabilities are not defined, a message is output.

%INCLUDE "$SMGTRMPTR" %FROM %LIBRARY "SYS$LIBRARY: BASIC$STARLET"
OPTION TYPE = EXPLICIT, SIZE = INTEGER LONG

EXTERNAL INTEGER FUNCTION SYS$ASSIGN, SYS$DASSGN, SYS$QIOW
EXTERNAL INTEGER FUNCTION LIB$GETDVI, LIB$GET_EF, LIB$FREE_EF
EXTERNAL INTEGER FUNCTION SMG$INIT_TERM_TABLE_BY_TYPE, SMG$GET_TERM_DATA

EXTERNAL INTEGER CONSTANT IO$_WRITEVBLK, DVI$_DEVTYPE

COMMON (buf) STRING Data_buffer = 20          ! buffer to hold terminal data

DECLARE INTEGER Sys_status,                   &
              Chan,                           &
              Term_type,                      &
              Term_table_addr,               &
              Arg_vector (2),                &
              Ret_len,                       &
              Event_flag

! Assign a channel for LIB$GETDVI and SYS$QIOW.
Sys_status = SYS$ASSIGN ('SYS$OUTPUT', Chan, , , )

IF (Sys_status AND 1%) = 0%
THEN
  PRINT "Error from SYS$ASSIGN : ";Sys_status
  GOTO Done
END IF

! Get the terminal type.
Sys_status = LIB$GETDVI (DVI$_DEVTYPE      ! request item code          &
                        ,Chan              ! channel assigned to SYS$OUTPUT &
                        ,                  ! omit device name              &
                        ,Term_type)       ! place to return type

IF (Sys_status AND 1%) = 0%
THEN
  PRINT "Error from LIB$GETDVI : ";Sys_status
  GOTO Done
END IF

! Get the definition for the type of terminal we are running on.
Sys_status = SMG$INIT_TERM_TABLE_BY_TYPE (Term_type, Term_table_addr)

IF (Sys_status AND 1%) = 0%
THEN
  PRINT "Error getting terminal definition : ";Sys_status
  GOTO Done
END IF

! Get the sequence to position the cursor to 12,1
Arg_vector (0) = 2%          ! number of args to follow
Arg_vector (1) = 12%         ! row number
Arg_vector (2) = 1%          ! column number

```

Support for Third-Party Terminals 5.4 Examples

```

Sys_status = SMG$GET_TERM_DATA                                     &
    ( Term_table_addr      ! addr of terminal definition &
      ,SMG$K_SET_CURSOR_ABS ! request code             &
      ,20%                 ! max buffer length        &
      ,Ret_len             ! length of sequence returned &
      ,Data_buffer BY REF  ! buffer to hold sequence   &
      ,Arg_vector (0) )    ! optional vector with     &
                          ! row and column numbers

IF (Sys_status AND 1%) = 0%
THEN
    PRINT "Error getting cursor sequence : ";Sys_status
    GOTO Done
END IF

IF Ret_len = 0%
THEN
    PRINT "Cursor sequence not available"
    GOTO Done
END IF

! Get a unique event flag number
Sys_status = LIB$GET_EF (Event_flag)

IF (Sys_status AND 1%) = 0%
THEN
    PRINT "Unable to allocate an event flag"
    GOTO Done
END IF

! Output the cursor sequence to the terminal.
Sys_status = SYS$QIOW ( Event_flag BY VALUE      ! event flag number &
                       ,Chan BY VALUE           ! channel number     &
                       ,IO$_WRITEVBLK BY VALUE  ! function code      &
                       , , ,                   ! no iosb,          &
                       , , ,                   ! ast routine,      &
                       , , ,                   ! or argument       &
                       ,Data_buffer BY REF      ! buffer to output  &
                       ,Ret_len BY VALUE       ! bytes returned    &
                       , , , , )               ! null arguments

IF (Sys_status AND 1%) = 0%
THEN
    PRINT "Error from SYS$QIOW : ";Sys_status
    GOTO Done
END IF

! Get the sequence to erase from current cursor to end of screen.
Sys_status = SMG$GET_TERM_DATA                                     &
    ( Term_table_addr ! addr of terminal definition &
      ,SMG$K_ERASE_TO_END_DISPLAY ! request code &
      ,20%                 ! max buffer length &
      ,Ret_len             ! bytes returned &
      ,Data_buffer BY REF) ! buffer for sequence

IF (Sys_status AND 1%) = 0%
THEN
    PRINT "Error getting erase sequence : ";Sys_status
    GOTO Done
END IF

IF Ret_len = 0%
THEN
    PRINT "Erase sequence not available"
    GOTO Done
END IF

! Output the erase sequence to the terminal.

```

Support for Third-Party Terminals

5.4 Examples

```

Sys_status = SYS$QIOW (Event_flag BY VALUE      ! event flag number   &
                      ,Chan BY VALUE           ! channel number      &
                      ,IO$_WRITEVBLK BY VALUE  ! function code value &
                      , , ,                    ! no iosb,           &
                      , , ,                    ! ast routine,       &
                      , , ,                    ! or argument        &
                      ,Data_buffer BY REF      ! buffer to output    &
                      ,Ret_len BY VALUE       ! bytes in buffer     &
                      , , , , )                ! null arguments

IF (Sys_status AND 1%) = 0%
THEN
  PRINT "Error from SYS$QIOW : ";Sys_status
  GOTO Done
END IF

! Deassign the channel.

Sys_status = SYS$DASSGN (Chan BY VALUE)

IF (Sys_status AND 1%) = 0%
THEN
  PRINT "Error from SYS$DASSGN : ";Sys_status
  GOTO Done
END IF

! Deallocate event flag so other programs can use it.

Sys_status = LIB$FREE_EF (Event_flag)

IF (Sys_status AND 1%) = 0%
THEN
  PRINT "Unable to deallocate event flag"
  GOTO Done
END IF

32767 Done: END
```

5.5 Creating TERMTABLE.EXE

Accessing an ASCII file for each screen program is inefficient because the ASCII text must be processed as binary information before it can be returned as a string ready for the terminal. To avoid paying the price of this processing at the start of every image, TERMTABLE.TXT is “precompiled” into the required binary format. A screen application then gets its terminal sequences from the precompiled binary capabilities file.

Compile TERMTABLE.TXT by running the SYS\$SYSTEM:SMGBLDTRM.EXE program. This utility accepts TERMTABLE.TXT as an input file and creates TERMTABLE.EXE as an output file on the device and directory pointed to by the logical TERM\$TABLOC.

The compiled terminal capabilities are stored as a table in a file which is mapped as a permanent global section. Thus, user programs map to the global section rather than having their own copies of the capabilities data.

If a user compiles a private TERMTABLE.TXT from his or her own directory, the interface routines access it by mapping it as a temporary section. TERMTABLE interface routines look for a definition in the temporary section before looking in the system’s permanent global section.

Note that system managers may want to coordinate terminal definitions so that nonstandard definitions are confined to a user’s private area.

Most users do not have the privilege to create a permanent global section. A short program, SYSS\$SYSTEM:SMGMAPTRM.EXE, that maps the compiled TERMTABLE as a global section, is part of the standard OpenVMS startup procedure. In order to map an updated TERMTABLE.EXE as the global section, the existing global section must first be deleted. Deleting the global section while the system is active may cause a user's program to fail; therefore the system must be rebooted in order to make an updated TERMTABLE.EXE the default.

To reduce compiling time and the size of the resulting global section, the terminal definitions in SYSS\$SYSTEM:TERMTABLE.TXT should be kept to a minimum. Only the types of terminals that are actually attached to the computer system should be defined.

5.6 Capability Fields Used by Screen Management

The tables in Section 5.2 show whether or not the Screen Management Facility can request a particular capability string. Some functions, such as wide characters or line drawing, are requested only if the user calls the screen management routines that output wide text or draw lines. If all you want to do is write normal text to the screen, only the following set of fields needs to be defined.

Essential Capabilities

- NAME
- SET_CURSOR_ABS

If SET_CURSOR_ABS is omitted, the Screen Management Facility treats the terminal as a hardcopy device. (For more information on using the Screen Management Facility with a hardcopy device, refer to SMG\$SNAPSHOT)

Operation of the Screen Management Facility is more efficient if the following optional capabilities are also provided:

- ERASE_TO_END_DISPLAY
- ERASE_TO_END_LINE
- SET_SCROLLING_REGION

If you do not include ERASE_TO_END_DISPLAY, ERASE_TO_END_LINE, or SET_SCROLLING_REGION, the Screen Management Facility inserts blanks to perform these functions. However, inserting blanks is a slower operation. Similarly, hardware scrolling also improves output speed; if scrolling is not available, the Screen Management Facility must rewrite the entire screen.

The Screen Management Facility uses the ASCII character set. If your terminal has a line-drawing character set, you should define the line drawing characters (*bottom_t_char*, *horizontal_bar*, and so forth). If line-drawing characters are not defined, the Screen Management Facility uses normal ASCII characters to draw borders.

The Screen Management Facility also relies on the terminal characteristics maintained by the terminal driver. You can change these characteristics with the DCL command SET TERMINAL. For example, if you type SET TERMINAL/NOTAB, then the Screen Management Facility does not send tabs to the terminal.

Support for Third-Party Terminals

5.7 Input Support for Foreign Terminals

5.7 Input Support for Foreign Terminals

A **foreign terminal** is any terminal for which the device type is not one of the standard Compaq terminals recognized by the OpenVMS operating system, or any terminal on which the ANSI_CRT characteristic is not set.

When you use a Compaq (or ANSI) terminal, typing a special key such as a function key or a keypad key sends an escape sequence (as defined by the ANSI standard) to the OpenVMS terminal driver. The OpenVMS terminal driver understands this ANSI standard and interprets the escape sequence according to this standard. Thus, the OpenVMS terminal driver knows how long the escape sequence is and what characters are allowed in which positions in that sequence.

The OpenVMS terminal driver does not echo any of the printing characters from the sequence because those characters are interpreted with special meaning as part of the escape sequence. Normal keys are echoed unless the TRM\$M_TM_NOECHO modifier is specified.

The OpenVMS terminal driver returns to the Screen Management Facility the sequence, the length of the sequence, and the number of characters entered before the function key was pressed. The Screen Management Facility determines which key was pressed by comparing the sequence and its length against the list of key definitions for that particular terminal in TERMTABLE.EXE. This code is returned to the user in the format SMG\$K_TRM_XXX, where XXX is used to specify the particular key.

When you press a special key such as a function key or a keypad key on a foreign terminal, a non-ANSI sequence is sent to the OpenVMS terminal driver. If this sequence starts with a control character, the OpenVMS terminal driver interprets this character as a terminator. (By default all control characters are terminators unless you use a terminator mask to specify otherwise.) The terminal driver then stops reading characters and returns to the Screen Management Facility the character, a length of 1, and the number of characters entered before the function key was pressed.

The Screen Management Facility looks at the returned character. If it is a control character, the Screen Management Facility looks in the type-ahead buffer for the next characters of the sequence. If there are characters in the type-ahead buffer, the Screen Management Facility reads one character from the type-ahead buffer, appends it to the control sequence it has already, and checks this new sequence against the list of key definitions for this terminal in TERMTABLE.EXE to determine which key was pressed. If the sequence is not matched, the next character is read from the type-ahead buffer. This continues until a match is found or the type-ahead buffer is empty. Since the terminal driver does not know about this sequence, any printable characters in the sequence are echoed by the terminal driver unless the noecho modifier was specified by the user. Because the Screen Management Facility does not know what characters make up this sequence, it disables line editing in order to allow the actual characters that make up the sequence to be returned to the Screen Management Facility.

Terminals whose special keys send a sequence that does not start with a control character are not supported by the Screen Management Facility for input. Changing the terminator mask to exclude the control character that starts the function key sequence is not supported. In addition, the performance of a foreign terminal doing input will not match that of a Compaq terminal doing the same input since SMG\$ must parse the sequence in place of the OpenVMS terminal driver.

5.8 Support for SET and SHOW TERMINAL Commands

The DCL command SET TERMINAL is the mechanism for setting your terminal to conform to a TERMTABLE definition. SET TERMINAL causes the following three fields to be retrieved from the TERMTABLE database and set for your terminal:

- Terminal type—A signed integer assigned by the system and associated with a particular device type
- Width—The number of columns on the physical screen
- Page size—The number of rows on the screen

In addition, if the corresponding Boolean capability is set in the terminal definition, the following flags are set:

- ADVANCED_VIDEO
- ANSI_COLOR
- ANSI_CRT
- BLOCK_MODE
- DEC_CRT
- EDIT
- EIGHT_BIT
- FORM
- FULLDUP
- LOWERCASE
- REGIS
- SCOPE
- SIXEL_GRAPHICS
- SOFT_CHARACTERS
- TAB

If any of these fields is missing from your definition, the previous setting for that characteristic is retained; SET TERMINAL does not try to set that characteristic for your terminal. You should include all of the above capabilities in your definitions to avoid unpredictable settings.

SET TERMINAL operates as it always has for known terminals such as the VT300 series, VT200 series, VT100, and VT52. When SET TERMINAL encounters an unknown device name, it searches TERMTABLE for a definition with that name. Notice that your definitions must have names other than the names that SET TERMINAL currently recognizes. The terminals currently recognized are listed as follows:

| | | |
|------|-------|--------------|
| LA12 | VT05 | VT131 |
| LA34 | VT52 | VT132 |
| LA36 | VT55 | VT200-SERIES |
| LA38 | VT100 | VT300-SERIES |

Support for Third-Party Terminals

5.8 Support for SET and SHOW TERMINAL Commands

| | | |
|---------|-------|-----------------|
| LA100 | VT101 | VT400-SERIES |
| LA120 | VT102 | VT500-SERIES |
| LQP02 | VT125 | FT1 through FT8 |
| Unknown | | |

If SET TERMINAL finds the device name in its own internal tables, it does not search the TERMTABLE database.

Since the SET TERMINAL command recognizes only the first 15 characters of a device name, you may want to limit your terminal names to 15 characters.

The SET TERMINAL/DEVICE=*name* command causes the TERMTABLE database to be searched for the named terminal, if that terminal is unknown to the OpenVMS operating system. SET TERMINAL/DEVICE=*name* then sets various terminal characteristics, as shown in the following table, based on the presence of these capabilities in the TERMTABLE database:

| Capability Field | Terminal Characteristic |
|------------------|-------------------------|
| LOWERCASE | LOWERCASE |
| PHYSICAL_TABS | TABS |
| SCOPE | SCOPE |
| EIGHT_BIT | EIGHTBIT |
| PHYSICAL_FF | FORM |
| FULLDUP | FULLDUP |
| SIXEL_GRAPHICS | SIXEL |
| SOFT_CHARACTERS | SOFT |
| ANSI_CRT | ANSI_CRT |
| ANSI_COLOR | ANSI_COLOR |
| REGIS | REGIS |
| BLOCK_MODE | BLOCK |
| ADVANCED_VIDEO | AVO |
| EDIT_MODE | EDIT |
| DEC_CRT | DEC_CRT |

The SET TERMINAL/DEVICE_TYPE=*format* must be used with TERMTABLE terminals. SET TERMINAL/*name* is an old format that works for a small set of device names and is maintained only for compatibility with previous versions of the OpenVMS operating system.

Using Screen Management Routines to Develop New Programs

This chapter discusses some recommended methods for using the Screen Management Facility for developing new programs.

Important

Screen management routines are not AST reentrant.

6.1 Calling Screen Management Routines

There are two ways in which an application can call screen management routines.

- Directly

Applications that call the Screen Management Facility directly already use pasteboards and virtual displays.

- Indirectly

This kind of application does not use the Screen Management Facility directly, but may use it in the course of invoking other routines.

Because many callable routines may use the Screen Management Facility to produce their output, it is difficult to determine whether your application is in this category.

In either case, the calling routine is likely at some point to call a subsystem so that the subsystem can write data to the screen.

At some later point, the terminal user will want to remove the subsystem-specific display. However, if the subsystem created and used a virtual display to display the data, the display identifier is not available to the calling program and therefore the calling program cannot remove it. Furthermore, unless the calling program is a direct user of the Screen Management Facility, the screen's pasteboard identifier is also not available to it.

The solution is to require that all callable routines that use the Screen Management Facility, directly or indirectly, have an (optional) input argument for the **pasteboard-id** and an (optional) output argument for the virtual **display-id**. Passing the pasteboard and display identifiers lets you avoid accumulating subsystem-specific data on the screen that cannot be removed by the calling program.

Using Screen Management Routines to Develop New Programs

6.1 Calling Screen Management Routines

These guidelines are developed as follows:

- If the **pasteboard-id** argument is provided by the calling program, then:
 - The called program should not create a pasteboard of its own.
 - The called program must deliver all of its output to the pasteboard supplied by the calling program; that is, the called program may paste its displays only to the pasteboard specified by **pasteboard-id**.
 - The called program can delete any virtual displays it created by calling `SMG$DELETE_VIRTUAL_DISPLAY`, but it must not delete the pasteboard.

Note that the called program should not simply call the `SMG$UNPASTE_VIRTUAL_DISPLAY` routine with the expectation that this virtual display can be reused in a later invocation. Since the called program and the calling program are sharing a pasteboard, the calling program may use the `SMG$POP_VIRTUAL_DISPLAY` routine to delete all displays created by the called program.
 - The called program must pass the **pasteboard-id** on to any routines it in turn calls. Thus all output is directed to the specified pasteboard.
- If the **pasteboard-id** argument is not provided by the calling program, then:
 - The called program must create a pasteboard on its own. The called program may allocate any physical device for the pasteboard, unless specifically directed to a particular device by some other mechanism.

The called program must check the status of the `SMG$CREATE_PASTEBOARD` call to see whether it created a unique pasteboard identifier or whether it received the pasteboard identifier of an already existing pasteboard. If the pasteboard already exists, the called program must not delete the pasteboard.
 - If the called routine creates a pasteboard and in turn calls subroutines that may use pasteboards, it should pass the **pasteboard-id** to the subroutines.
 - The called program can clean up by using the `SMG$UNPASTE_VIRTUAL_DISPLAY` routine, and the displays can be saved for reuse on a subsequent invocation if such a call seems likely. However, the `SMG$UNPASTE_VIRTUAL_DISPLAY` routine should be used only if the called program creates its own pasteboard, because in this case the calling program cannot delete the virtual displays created by the called program.
- If the virtual **display-id** argument is provided by the calling program, then the calling program must clean up any virtual displays created by the called program. The called program must return to the calling program the identifier of the first virtual display pasted. The calling program can then remove this and all later-pasted virtual displays by calling the `SMG$POP_VIRTUAL_DISPLAY` routine.
- If the virtual **display-id** argument is not provided by the calling program, the called program must remove all the virtual displays it pastes to the pasteboard.

Using Screen Management Routines to Develop New Programs

6.1 Calling Screen Management Routines

By adhering to the following guidelines, you can develop your application in a modular fashion:

- Calling programs control the pasteboard on which information is pasted. Pasteboard identifiers flow downward in a hierarchy, with each routine using the **pasteboard-id** provided by the caller and passing it along to subroutines.
- If a calling program supplies a virtual **display-id** argument to be filled in by the called program, then the calling program assumes responsibility for cleaning up any displays created by the called program. The called program passes back the **display-id** of the first virtual display pasted so that the calling program can remove this and all later-pasted displays by calling the `SMG$POP_VIRTUAL_DISPLAY` routine.
- Virtual displays are created (and pasted) in the routine where they are needed. If the calling program does not supply a **display-id** argument, then displays are unpasted and/or deleted in the routine that created them.

6.2 Calling Routines That Do Not Use the Screen Management Facility

A different situation exists if you call a subroutine (or subsystem) that writes to the screen without using the Screen Management Facility. When the Screen Management Facility is bypassed (that is, when text is placed on the screen outside screen management's control), problems result when an attempt is made to perform a screen update.

For this reason, the Screen Management Facility provides two routines for turning over the screen (or a part of it) temporarily to a program that does not use screen management, and for restoring the screen to its previous state after control is returned from the non-SMG\$ routine. These routines are `SMG$SAVE_PHYSICAL_SCREEN` and `SMG$RESTORE_PHYSICAL_SCREEN`.

Before you call a routine that performs non-SMG\$ I/O to the screen, you should call the `SMG$SAVE_PHYSICAL_SCREEN` routine, specifying what part of the screen is to be turned over to the non-SMG\$ routine. `SMG$SAVE_PHYSICAL_SCREEN` erases the specified area, sets the terminal's physical scrolling region to this area, and sets the physical cursor to row 1, column 1 of the area. If the non-SMG\$ code does only sequential input and output (that is, if it does no direct cursor addressing) its output will be confined to the specified area of the screen.

When control is returned from the non-SMG\$ routine, you simply call `SMG$RESTORE_PHYSICAL_SCREEN`, which restores the screen image as it was before the call to `SMG$SAVE_PHYSICAL_SCREEN`.

Examples of Calling SMG\$ Routines

This chapter contains examples demonstrating how to call the routine `SMG$READ_KEYSTROKE` from the major programming languages. Note that not all of the languages represented in these examples are available on OpenVMS Alpha systems. The following languages are supported on Alpha systems:

| | | | |
|----------|--------|---------|-----------------------|
| Ada | BASIC | BLISS | C |
| C++ | COBOL | Fortran | MACRO-32 ¹ |
| MACRO-64 | Pascal | PL/I | |

¹Note that MACRO-32 must be compiled with the AMACRO compiler.

Other SMG\$ routines such as `SMG$CREATE_VIRTUAL_DISPLAY`, `SMG$CREATE_PASTEBOARD`, `SMG$CREATE_VIRTUAL_KEYBOARD`, `SMG$PASTE_VIRTUAL_DISPLAY`, and `SMG$PUT_LINE` are also used throughout these examples.

Example 7-1 demonstrates the use of `SMG$READ_KEYSTROKE` from a Compaq Ada program. This program also uses `SMG$CREATE_VIRTUAL_DISPLAY`, `SMG$CREATE_PASTEBOARD`, `SMG$CREATE_VIRTUAL_KEYBOARD`, `SMG$PASTE_VIRTUAL_DISPLAY`, and `SMG$PUT_LINE`.

Example 7-1 Using SMG\$ Routines in Compaq Ada

with SYSTEM, CONDITION_HANDLING; use SYSTEM;
 package SMG is -- declarations of SMG\$ routines used

```

  procedure CREATE_VIRTUAL_DISPLAY (
    STATUS: out CONDITION_HANDLING.COND_VALUE_TYPE;
    ROWS, COLUMNS: INTEGER;
    DISPLAY_ID: out INTEGER;
    DISPLAY_ATTRIBUTES, VIDEO_ATTRIBUTES, CHAR_SET: UNSIGNED_LONGWORD
      := UNSIGNED_LONGWORD'NULL_PARAMETER);
  pragma INTERFACE (SMG, CREATE_VIRTUAL_DISPLAY);
  pragma IMPORT_VALUED_PROCEDURE
    (CREATE_VIRTUAL_DISPLAY, "SMG$CREATE_VIRTUAL_DISPLAY");

```

(continued on next page)

Examples of Calling SMG\$ Routines

Example 7-1 (Cont.) Using SMG\$ Routines in Compaq Ada

```
procedure CREATE_PASTEBOARD (
  STATUS: out CONDITION_HANDLING.COND_VALUE_TYPE;
  PASTEBOARD_ID: out INTEGER;
  OUTPUT_DEVICE: STRING := STRING'NULL_PARAMETER;
  ROWS, COLUMNS: INTEGER := INTEGER'NULL_PARAMETER;
  PRESERVE_SCREEN_FLAG: BOOLEAN := BOOLEAN'NULL_PARAMETER);
pragma INTERFACE (SMG, CREATE_PASTEBOARD);
pragma IMPORT_VALUED_PROCEDURE
  (CREATE_PASTEBOARD, "SMG$CREATE_PASTEBOARD");

procedure CREATE_VIRTUAL_KEYBOARD (
  STATUS: out CONDITION_HANDLING.COND_VALUE_TYPE;
  KEYBOARD_ID: out INTEGER;
  FILESPEC, DEFAULT_FILESPEC, RESULTANT_FILESPEC: STRING
  := STRING'NULL_PARAMETER);
pragma INTERFACE (SMG, CREATE_VIRTUAL_KEYBOARD);
pragma IMPORT_VALUED_PROCEDURE
  (CREATE_VIRTUAL_KEYBOARD, "SMG$CREATE_VIRTUAL_KEYBOARD");

procedure PASTE_VIRTUAL_DISPLAY (
  STATUS: out CONDITION_HANDLING.COND_VALUE_TYPE;
  DISPLAY_ID, PASTEBOARD_ID: INTEGER;
  ROW, COLUMN: INTEGER);
pragma INTERFACE (SMG, PASTE_VIRTUAL_DISPLAY);
pragma IMPORT_VALUED_PROCEDURE
  (PASTE_VIRTUAL_DISPLAY, "SMG$PASTE_VIRTUAL_DISPLAY");

procedure READ_KEYSTROKE (
  STATUS: out CONDITION_HANDLING.COND_VALUE_TYPE;
  KEYBOARD_ID: INTEGER;
  TERMINATOR_CODE: out UNSIGNED_WORD;
  PROMPT: STRING := STRING'NULL_PARAMETER;
  TIMEOUT, DISPLAY_ID: INTEGER := INTEGER'NULL_PARAMETER);
pragma INTERFACE (SMG, READ_KEYSTROKE);
pragma IMPORT_VALUED_PROCEDURE
  (READ_KEYSTROKE, "SMG$READ_KEYSTROKE");

procedure PUT_LINE (
  STATUS: out CONDITION_HANDLING.COND_VALUE_TYPE;
  DISPLAY_ID: INTEGER;
  TEXT: STRING;
  LINE_ADVANCE: INTEGER := INTEGER'NULL_PARAMETER;
  RENDITION_SET, RENDITION_COMPLEMENT: UNSIGNED_LONGWORD
  := UNSIGNED_LONGWORD'NULL_PARAMETER;
  WRAP_FLAG: BOOLEAN := BOOLEAN'NULL_PARAMETER;
  CHAR_SET: UNSIGNED_LONGWORD := UNSIGNED_LONGWORD'NULL_PARAMETER);
pragma INTERFACE (SMG, PUT_LINE);
pragma IMPORT_VALUED_PROCEDURE
  (PUT_LINE, "SMG$PUT_LINE");
end SMG;
```

(continued on next page)

Examples of Calling SMG\$ Routines

Example 7-1 (Cont.) Using SMG\$ Routines in Compaq Ada

```
-- This routine demonstrates the use of the SMG$ routines, in particular
-- SMG$READ_KEYSTROKE.

with SMG, STARLET, CONDITION_HANDLING, SYSTEM;
procedure SMG_DEMO is
  STATUS: CONDITION_HANDLING.COND_VALUE_TYPE;
  PASTEBOARD_1, DISPLAY_1, KEYBOARD_1: INTEGER;
  TERMINATOR: SYSTEM.UNSIGNED_WORD;
begin
  -- Create virtual display, pasteboard and virtual keyboard.
  SMG.CREATE_VIRTUAL_DISPLAY (STATUS, ROWS => 7, COLUMNS => 60,
    DISPLAY_ID => DISPLAY_1,
    DISPLAY_ATTRIBUTES => STARLET.SMG_M_BORDER);
  SMG.CREATE_PASTEBOARD (STATUS, PASTEBOARD_ID => PASTEBOARD_1);
  SMG.CREATE_VIRTUAL_KEYBOARD (STATUS, KEYBOARD_ID => KEYBOARD_1);

  -- Paste the virtual display at row 3, column 9.
  SMG.PASTE_VIRTUAL_DISPLAY (STATUS, DISPLAY_ID => DISPLAY_1,
    PASTEBOARD_ID => PASTEBOARD_1, ROW => 3, COLUMN => 9);

  -- Write the instructions to the virtual display.
  SMG.PUT_LINE (STATUS, DISPLAY_ID => DISPLAY_1,
    TEXT => "Enter the character K after the >> prompt.");
  SMG.PUT_LINE (STATUS, DISPLAY_ID => DISPLAY_1,
    TEXT => "This character will not be echoed as you type it.");
  SMG.PUT_LINE (STATUS, DISPLAY_ID => DISPLAY_1,
    TEXT => "The terminal character equivalent of K is displayed.");
  SMG.PUT_LINE (STATUS, DISPLAY_ID => DISPLAY_1,
    TEXT => " ");

  -- Read the keystroke from the virtual keyboard.
  SMG.READ_KEYSTROKE (STATUS, KEYBOARD_ID => KEYBOARD_1,
    DISPLAY_ID => DISPLAY_1,
    TERMINATOR_CODE => TERMINATOR, PROMPT => ">>");

  -- Display the decimal value of the terminator code.
  SMG.PUT_LINE (STATUS, DISPLAY_ID => DISPLAY_1,
    TEXT => " ");
  SMG.PUT_LINE (STATUS, DISPLAY_ID => DISPLAY_1,
    TEXT => "TERMINAL CHARACTER IS " &
      SYSTEM.UNSIGNED_WORD'IMAGE(TERMINATOR));
end SMG_DEMO;
```

Examples of Calling SMG\$ Routines

Example 7-2 uses SMG\$READ_KEYSTROKE to read a keystroke from the terminal. This BASIC program also uses SMG\$CREATE_VIRTUAL_KEYBOARD and SMG\$DELETE_VIRTUAL_KEYBOARD.

Example 7-2 Using SMG\$ Routines in Compaq BASIC

```
1      OPTION TYPE=EXPLICIT
      !+
      ! This routine demonstrates the use of SMG$READ_KEYSTROKE to read
      ! a keystroke from the terminal.
      !
      ! Build this program using the following commands.
      !
      !$ BASIC READ_KEY
      !$ CREATE SMGDEF.MAR
      !       .TITLE  SMGDEF - Define SMG$ constants
      !       .Ident  /1-000/
      !
      !       $SMGDEF GLOBAL
      !
      !       .END
      !$ MACRO SMGDEF
      !$ LINK READ_KEY,SMGDEF
      !
      !-

      DECLARE LONG KB_ID, RET_STATUS, TERM_CODE, I, TIMER
      EXTERNAL SUB LIB$SIGNAL( LONG BY VALUE )
      EXTERNAL SUB LIB$STOP( LONG BY VALUE )
      EXTERNAL LONG CONSTANT SS$_TIMEOUT
      EXTERNAL LONG CONSTANT SMG$K_TRM_PF1
      EXTERNAL LONG CONSTANT SMG$K_TRM_PERIOD
      EXTERNAL LONG CONSTANT SMG$K_TRM_UP
      EXTERNAL LONG CONSTANT SMG$K_TRM_RIGHT
      EXTERNAL LONG CONSTANT SMG$K_TRM_F6
      EXTERNAL LONG CONSTANT SMG$K_TRM_F20
      EXTERNAL LONG CONSTANT SMG$K_TRM_FIND
      EXTERNAL LONG CONSTANT SMG$K_TRM_NEXT_SCREEN
      EXTERNAL LONG CONSTANT SMG$K_TRM_TIMEOUT
      EXTERNAL LONG FUNCTION SMG$CREATE_VIRTUAL_KEYBOARD( LONG, STRING )
      EXTERNAL LONG FUNCTION SMG$DELETE_VIRTUAL_KEYBOARD( LONG )
      EXTERNAL LONG FUNCTION SMG$READ_KEYSTROKE( LONG, LONG, STRING, &
          LONG, LONG )

      !+
      ! Prompt the user for the timer value. A value of 0 will cause
      ! the type-ahead buffer to be read.
      !-

      INPUT "Enter timer value (0 to read type-ahead buffer): ";TIMER

      !+
      ! Establish a SMG connection to SYS$INPUT. Signal any unexpected
      ! errors.
      !-

      RET_STATUS = SMG$CREATE_VIRTUAL_KEYBOARD( KB_ID, "SYS$INPUT:" )
      IF (RET_STATUS AND 1%) = 0% THEN
          CALL LIB$SIGNAL( RET_STATUS )
      END IF
```

(continued on next page)

Examples of Calling SMG\$ Routines

Example 7-2 (Cont.) Using SMG\$ Routines in Compaq BASIC

```
!+
!   Read a keystroke, tell the user what we found.
!-

RET_STATUS = SMG$READ_KEYSTROKE( KB_ID, TERM_CODE, , TIMER, )
IF (RET_STATUS <> SS$TIMEOUT) AND ((RET_STATUS AND 1%) = 0%) THEN
    CALL LIB$SIGNAL( RET_STATUS )
END IF

PRINT "term_code = ";TERM_CODE

SELECT TERM_CODE
    CASE 0 TO 31
        PRINT "You typed a control character"
    CASE 32 TO 127
        PRINT "You typed: ";CHR$(TERM_CODE)
    CASE SMG$K_TRM_PF1 TO SMG$K_TRM_PERIOD
        PRINT "You typed one of the keypad keys"
    CASE SMG$K_TRM_UP TO SMG$K_TRM_RIGHT
        PRINT "You typed one of the cursor positioning keys"
    CASE SMG$K_TRM_F6 TO SMG$K_TRM_F20
        PRINT "You typed one of the function keys"
    CASE SMG$K_TRM_FIND TO SMG$K_TRM_NEXT_SCREEN
        PRINT "You typed one of the editing keys"
    CASE SMG$K_TRM_TIMEOUT
        PRINT "You did not type a key fast enough"
    CASE ELSE
        PRINT "I'm not sure what key you typed"
END SELECT

!+
!   Close the connection to SYS$INPUT, and signal any errors.
!-

RET_STATUS = SMG$DELETE_VIRTUAL_KEYBOARD( KB_ID )
IF (RET_STATUS AND 1%) = 0% THEN
    CALL LIB$SIGNAL( RET_STATUS )
END IF

END
```

Examples of Calling SMG\$ Routines

The BLISS program in Example 7-3 demonstrates the use of SMG\$READ_KEYSTROKE from a lower-level language.

Example 7-3 Using SMG\$ Routines in VAX BLISS-32

```
MODULE READ_SINGLE_CHAR (      MAIN = PERFORM_READ,
                              %TITLE 'Read a Keystroke from SYS$INPUT'
                              IDENT = '1-001' ) =
BEGIN
!+
! Facility:      Example programs
!
! Abstract:      This example program uses the routine SMG$READ_KEYSTROKE
!                to get a single character input from the current SYS$INPUT
!                device and then indicates the nature of the input to the user.
!
! Environment:   User mode, AST reentrant
!
! Author:        John Doe      Creation Date:  8-Apr-1985
!
! Modified by:
! 1-001 - Original.  JD 8-Apr-1985
!-

!+
! General mode addressing must be used for external references.
!-

%SBTTL 'Declarations'
SWITCHES ADDRESSING_MODE (EXTERNAL=GENERAL, NONEXTERNAL=WORD_RELATIVE);

!+
! Obtain SMG$, SS$, etc. definitions.
!-

LIBRARY 'SYS$LIBRARY:STARLET';

!+
! Use the TUTIO package for the purposes of this small example.
!-

REQUIRE 'SYS$LIBRARY:TUTIO';

!+
! Declare screen management routines used by this program, as well as
! any other external routines.
!-

EXTERNAL ROUTINE
    SMG$CREATE_VIRTUAL_KEYBOARD,
    SMG$DELETE_VIRTUAL_KEYBOARD,
    SMG$READ_KEYSTROKE,
    LIB$SIGNAL : NOVALUE;

!+
! Define a convenient way to check the return status from a routine.
!-
```

(continued on next page)

Examples of Calling SMG\$ Routines

Example 7-3 (Cont.) Using SMG\$ Routines in VAX BLISS-32

```
MACRO CHECK (X) =
IF NOT X
THEN
    LIB$SIGNAL (X)
%;

%SBTTL 'Routine PERFORM_READ'
ROUTINE PERFORM_READ: NOVALUE =

!+
! Functional Description:
!
!     This routine uses screen management I/O to get a single character
!     input from the current SYS$INPUT device, and then processes it by
!     what its character or termination code is.
!
! Calling Sequence:
!
!     Not Callable
!
! Formal Arguments:
!
!     Not Applicable
!
! Implicit Inputs:
!
!     None
!
! Implicit Outputs:
!
!     None
!
! Side Effects:
!
!     Any error returned by screen management routines except for
!     SSS_TIMEOUT will be signaled.
!-

BEGIN

    LITERAL
        ZERO = 0;

    LOCAL
        KBID : INITIAL(0),
        TERM_CODE : INITIAL(0),
        TIMER_VALUE : INITIAL(0),
        SMG_STATUS;

!+
! Obtain a read timeout value.
!-
```

(continued on next page)

Examples of Calling SMG\$ Routines

Example 7-3 (Cont.) Using SMG\$ Routines in VAX BLISS-32

```
TIMER_VALUE = 10;

!+
! Establish a screen managed connection to SYS$INPUT.
!-

SMG_STATUS = SMG$CREATE_VIRTUAL_KEYBOARD (KBID, %ASCID'SYS$INPUT');
CHECK (.SMG_STATUS);

!+
! Read a keystroke and tell the user what was found.
!-

SMG_STATUS = SMG$READ_KEYSTROKE (KBID, TERM_CODE, ZERO, TIMER_VALUE);
IF (.SMG_STATUS NEQ SS$TIMEOUT)
THEN
    CHECK (.SMG_STATUS);

SELECTONE .TERM_CODE OF
SET
    [0 TO 31]:
    TTY_PUT_QUO ('You typed a control character.');
```

```
    [32 TO 127]:
    TTY_PUT_QUO ('You typed a printable character.');
```

```
    [SMG$K_TRM_PF1 TO SMG$K_TRM_PERIOD]:
    TTY_PUT_QUO ('You typed one of the keypad keys.');
```

```
    [SMG$K_TRM_UP TO SMG$K_TRM_RIGHT]:
    TTY_PUT_QUO ('You typed one of the cursor positioning keys.');
```

```
    [SMG$K_TRM_F6 TO SMG$K_TRM_F20]:
    TTY_PUT_QUO ('You typed one of the function keys.');
```

```
    [SMG$K_TRM_FIND TO SMG$K_TRM_NEXT_SCREEN]:
    TTY_PUT_QUO ('You typed one of the editing keys.');
```

```
    [SMG$K_TRM_TIMEOUT]:
    TTY_PUT_QUO ('You did not type a key fast enough.');
```

```
    [OTHERWISE]:
    TTY_PUT_QUO ('I am not sure what you typed.');
```

```
TES;
TTY_PUT_CRLF ();
!+
! Terminate the screen managed connection to SYS$INPUT.
!-

SMG_STATUS = SMG$DELETE_VIRTUAL_KEYBOARD (KBID);
CHECK (.SMG_STATUS);

END;

END
ELUDOM
```

Examples of Calling SMG\$ Routines

Example 7-4 shows the techniques used to call SMG\$READ_KEYSTROKE from Compaq COBOL.

Example 7-4 Using SMG\$ Routines in Compaq COBOL

```
IDENTIFICATION DIVISION.
PROGRAM-ID.    KEYSTROKE.
*
* This routine creates a VIRTUAL DISPLAY and writes it to the PASTEBOARD.
* Data is placed in the VIRTUAL DISPLAY using the routine SMG$PUT_LINE.
* SMG$READ_KEYSTROKE is called to read a keystroke from the VIRTUAL KEYBOARD.
*
ENVIRONMENT DIVISION.
DATA DIVISION.
WORKING-STORAGE SECTION.
01 DISPLAY1          PIC 9(9)  COMP.
01 PASTE1            PIC 9(9)  COMP.
01 KEYBOARD1        PIC 9(9)  COMP.
01 ROWS              PIC S9(9) COMP    VALUE 7.
01 COLUMNS          PIC S9(9) COMP    VALUE 60.
01 DISPLAY_NAME     PIC X(13) VALUE " DISPLAY ONE ".
01 TERM_CHAR        PIC 9(4)  COMP.
01 T_TEXT           PIC X(6).
01 TEXT_OUTPUT      PIC X(24) VALUE " TERMINAL CHARACTER IS: ".
01 PROMPT           PIC X(2)  VALUE ">>".
01 LINE_1           PIC X(12) VALUE "Hit any key.".
01 LINE_2           PIC X(34) VALUE "This character will not be echoed.".
01 LINE_3           PIC X(47) VALUE "The terminal character equivalent is displayed.".
01 LINE_4           PIC X      VALUE " ".
01 THREE            PIC S9(9) COMP    VALUE 3.
01 NINE             PIC S9(9) COMP    VALUE 9.
01 SEVEN            PIC S9(9) COMP    VALUE 7.
01 TWENTY_FIVE     PIC S9(9) COMP    VALUE 25.
PROCEDURE DIVISION.
P0.
* Create the virtual display with a border.
      CALL "SMG$CREATE_VIRTUAL_DISPLAY" USING
          ROWS, COLUMNS, DISPLAY1.
* Create the pasteboard
      CALL "SMG$CREATE_PASTEBOARD" USING PASTE1.
* Create a virtual keyboard
      CALL "SMG$CREATE_VIRTUAL_KEYBOARD" USING KEYBOARD1.
* Paste the virtual display at row 3, column 9.
      CALL "SMG$LABEL_BORDER" USING DISPLAY1, BY DESCRIPTOR DISPLAY_NAME.
      CALL "SMG$PASTE_VIRTUAL_DISPLAY" USING
          DISPLAY1, PASTE1, THREE, NINE.
```

(continued on next page)

Examples of Calling SMG\$ Routines

Example 7-4 (Cont.) Using SMG\$ Routines in Compaq COBOL

```
* Place data in the virtual display
    CALL "SMG$PUT_LINE" USING DISPLAY1, BY DESCRIPTOR LINE_1.
    CALL "SMG$PUT_LINE" USING DISPLAY1, BY DESCRIPTOR LINE_2.
    CALL "SMG$PUT_LINE" USING DISPLAY1, BY DESCRIPTOR LINE_3.
    CALL "SMG$PUT_LINE" USING DISPLAY1, BY DESCRIPTOR LINE_4.

* Read a keystroke from the virtual pasteboard.
    CALL "SMG$READ_KEYSTROKE" USING KEYBOARD1, TERM_CHAR,
        BY DESCRIPTOR PROMPT, OMITTED, BY REFERENCE DISPLAY1.

    CALL "SMG$PUT_LINE" USING DISPLAY1, BY DESCRIPTOR LINE_4.

* Convert the decimal value of TERM_CHAR to a decimal ASCII text string.
    CALL "OTS$CVT_L_TI" USING TERM_CHAR, BY DESCRIPTOR T_TEXT.

* Print out the decimal ASCII text string.
    CALL "SMG$PUT_LINE" USING DISPLAY1, BY DESCRIPTOR TEXT_OUTPUT.
    CALL "SMG$PUT_CHARS" USING DISPLAY1, BY DESCRIPTOR T_TEXT,
        BY REFERENCE SEVEN, TWENTY_FIVE.

    STOP RUN.
```

The Fortran program shown in Example 7-5 uses `SMG$READ_KEYSTROKE` as well as `SMG$CREATE_VIRTUAL_DISPLAY`, `SMG$CREATE_PASTEBOARD`, `SMG$PASTE_VIRTUAL_DISPLAY`, `SMG$CREATE_VIRTUAL_KEYBOARD`, and `SMG$PUT_LINE`.

Example 7-5 Using SMG\$ Routines in Compaq Fortran

```
C+
C This routine creates a virtual display and writes it to the PASTEBOARD.
C Data is placed in the virtual display using the routine SMG$PUT_CHARS.
C Include the SMG definitions. In particular, we want SMG$M_BORDER.
C-
    INCLUDE '($SMGDEF)'
    INTEGER SMG$CREATE_VIRTUAL_DISPLAY, SMG$CREATE_PASTEBOARD
    INTEGER SMG$PASTE_VIRTUAL_DISPLAY,
1      SMG$CREATE_VIRTUAL_KEYBOARD
    INTEGER SMG$READ_KEYSTROKE, SMG$PUT_LINE
    INTEGER DISPLAY1, PASTE1, KEYBOARD1, ROWS, COLUMNS,
1      TERM_CHAR
    CHARACTER*3 TEXT
    CHARACTER*27 TEXT_OUTPUT

C+
C Create the virtual display with a border.
C-
    ROWS = 7
    COLUMNS = 60
```

(continued on next page)

Examples of Calling SMG\$ Routines

Example 7-5 (Cont.) Using SMG\$ Routines in Compaq Fortran

```
      ISTATUS = SMG$CREATE_VIRTUAL_DISPLAY
1      (ROWS, COLUMNS, DISPLAY1, SMG$M_BORDER)
C+
C Create the pasteboard.
C-
      ISTATUS = SMG$CREATE_PASTEBOARD (PASTE1)
C+
C Create a virtual keyboard.
C-
      ISTATUS = SMG$CREATE_VIRTUAL_KEYBOARD ( KEYBOARD1)
C+
C Paste the virtual display at row 3, column 9.
C-
      ISTATUS = SMG$PASTE_VIRTUAL_DISPLAY ( DISPLAY1, PASTE1, 3, 9)
      ISTATUS = SMG$PUT_LINE (DISPLAY1,
1      'Enter the character K after the >> prompt.')
      ISTATUS = SMG$PUT_LINE (DISPLAY1,
1      'This character will not be echoed as you type it.')
      ISTATUS = SMG$PUT_LINE (DISPLAY1,
1      'The terminal character equivalent of K is displayed.')
      ISTATUS = SMG$PUT_LINE (DISPLAY1, ' ')
C+
C Read a keystroke from the virtual pasteboard.
C-
      ISTATUS = SMG$READ_KEYSTROKE ( KEYBOARD1, TERM_CHAR, '>>', ,
1      DISPLAY1)
      ISTATUS = SMG$PUT_LINE (DISPLAY1, ' ')
C+
C Convert the decimal value of TERM_CHAR to a decimal ASCII text string.
C-
      ISTATUS = OTS$CVT_L_TI( TERM_CHAR, TEXT)
      TEXT_OUTPUT = ' TERMINAL CHARACTER IS: ' // TEXT
C+
C Print the decimal ASCII text string.
C-
      ISTATUS = SMG$PUT_LINE (DISPLAY1, TEXT_OUTPUT)
      ISTATUS = SMG$PUT_CHARS (DISPLAY1, TEXT, 7, 25)
      END
```

Examples of Calling SMG\$ Routines

The VAX MACRO program shown in Example 7–6 demonstrates the precise steps required to call SMG\$READ_KEYSTROKE from a low-level language.

Example 7–6 Using SMG\$ Routines in VAX MACRO

```
.TITLE SMG_DEMO

;+
; This program demonstrates the use of the SMG$ routines, in particular
; SMG$READ_KEYSTROKE.
;-

        $DSCDEF          ; Declare DSC$ symbols
        $SMGDEF          ; Declare SMG$ symbols

;+
; Declare external routines.
;-

        .EXTRN SMG$CREATE_PASTEBOARD
        .EXTRN SMG$CREATE_VIRTUAL_DISPLAY
        .EXTRN SMG$CREATE_VIRTUAL_KEYBOARD
        .EXTRN SMG$PUT_LINE
        .EXTRN SMG$READ_KEYSTROKE

;+
; Declare data PSECT and objects.
;-

        .PSECT $DATA RD,WRT,NOEXE,NOSHR,PIC

LINE1:  .ASCID "Enter the character K after the prompt."
LINE2:  .ASCID "This character will not be echoed as you type it."
LINE3:  .ASCID "The terminal character equivalent of K is displayed."
PROMPT: .ASCID ">>"
BLANK:  .ASCID " "
FAOSTR: .ASCID "TERMINAL CHARACTER IS !UL"

TEXT:   .BLKB 80      ; Buffer for formatted text
TEXT_LEN = . - TEXT      ; Length of TEXT
TEXT_DSC:      ; Descriptor for TEXT string
        .WORD TEXT_LEN      ; DSC$W_LENGTH
        .BYTE DSC$K_DTYPE_T ; DSC$B_DTYPE
        .BYTE DSC$K_CLASS_S ; DSC$B_CLASS
        .ADDRESS TEXT      ; DSC$A_POINTER

TERM_CHAR:
        .BLKL      ; Space for terminator character code
PASTEBOARD_1:
        .BLKL      ; Pasteboard ID
DISPLAY_1:
        .BLKL      ; Display ID
KEYBOARD_1:
        .BLKL      ; Keyboard ID
```

(continued on next page)

Examples of Calling SMG\$ Routines

Example 7-6 (Cont.) Using SMG\$ Routines in VAX MACRO

```

;+
; Declare PSECT for code.
;-

        .PSECT  $CODE RD,NOWRT,EXE,SHR,PIC

;+
; Begin main routine.
;-

        .ENTRY  SMG_DEMO, ^M<> ; Save no registers

;+
; Create virtual display.
;-

        PUSHL  #SMG$M_BORDER ; Put flag on stack
        PUSHL  #60           ; Put columns on stack
        PUSHL  #7           ; Put rows on stack
        PUSHAB 8(SP)        ; Address of flag
        PUSHABL ^DISPLAY_1  ; Address of display ID
        PUSHAB 12(SP)       ; Address of columns
        PUSHAB 12(SP)       ; Address of rows
        CALLS  #4, G^SMG$CREATE_VIRTUAL_DISPLAY
        ADDL2  #12, SP      ; Pop off temporaries

; Create pasteboard.
        PUSHAB L^PASTEBOARD_1 ; Address of pasteboard
        CALLS  #1, G^SMG$CREATE_PASTEBOARD

; Create virtual keyboard.
        PUSHAB L^KEYBOARD_1   ; Address of keyboard
        CALLS  #1, G^SMG$CREATE_VIRTUAL_KEYBOARD

; Paste the virtual display at row 3, column 9.
        PUSHL  #9           ; Put column on stack
        PUSHL  #3           ; Put row on stack
        PUSHAB 4(SP)        ; Address of column
        PUSHAB 4(SP)        ; Address of row
        PUSHABL ^PASTEBOARD_1 ; Address of pasteboard
        PUSHABL ^DISPLAY_1   ; Address of display
        CALLS  #4, G^SMG$PASTE_VIRTUAL_DISPLAY
        ADDL2  #8, SP      ; Pop off temporaries

; Write instructions.
        PUSHAB L^LINE1       ; "Enter the character..."
        PUSHABL ^DISPLAY_1   ; Display ID
        CALLS  #2, G^SMG$PUT_LINE
        PUSHABL ^LINE2       ; "This character will not..."
        PUSHABL ^DISPLAY_1   ; Display ID
        CALLS  #2, G^SMG$PUT_LINE
        PUSHABL ^LINE3       ; "The terminal character..."
        PUSHABL ^DISPLAY_1   ; Display ID
        CALLS  #2, G^SMG$PUT_LINE
        PUSHABL ^BLANK       ; Blank line
        PUSHABL ^DISPLAY_1   ; Display ID
        CALLS  #2, G^SMG$PUT_LINE

```

(continued on next page)

Examples of Calling SMG\$ Routines

Example 7-6 (Cont.) Using SMG\$ Routines in VAX MACRO

```
; Read a keystroke from the virtual keyboard.
    PUSHAB L^DISPLAY_1      ; Display ID
    CLRL   -(SP)            ; No timeout
    PUSHAB L^PROMPT         ; Prompt string
    PUSHAB L^TERM_CHAR      ; Longword for terminator code
    PUSHAB L^KEYBOARD_1     ; Keyboard ID
    CALLS  #5, G^SMG$READ_KEYSTROKE

; Format the terminator code using $FAO.
    $FAO_S CTRSTR=L^FAOSTR,-                ; FAO control string
           OUTLEN=L^TEXT_DSC+DSC$W_LENGTH,- ; Output string length
           OUTBUF=L^TEXT_DSC,-             ; Output buffer
           P1=L^TERM_CHAR                  ; Value to format

; Display the formatted text.
    PUSHABL ^BLANK          ; Blank line
    PUSHAB  L^DISPLAY_1     ; Display ID
    CALLS   #2, G^SMG$PUT_LINE
    PUSHAB  L^TEXT_DSC      ; Text to display
    PUSHAB  L^DISPLAY_1     ; Display ID
    CALLS   #2, G^SMG$PUT_LINE

; Return with status from last call.
    RET

    .END    SMG_DEMO        ; Specify SMG_DEMO as main program
```

Example 7-7 uses `SMG$READ_KEYSTROKE` from Compaq Pascal. It also demonstrates the use of `SMG$CREATE_VIRTUAL_DISPLAY`, `SMG$CREATE_PASTEBOARD`, `SMG$CREATE_VIRTUAL_KEYBOARD`, `SMG$PASTE_VIRTUAL_DISPLAY`, and `SMG$PUT_LINE`.

Example 7-7 Using SMG\$ Routines in Compaq Pascal

```
{ This program demonstrates the use of the SMG$ routines, in particular }
{ SMG$READ_KEYSTROKE. }

[INHERIT('SYS$LIBRARY:STARLET')]
PROGRAM SMG_DEMO;

TYPE
    UNSIGNED_WORD = [WORD] 0..65535;

FUNCTION SMG$CREATE_VIRTUAL_DISPLAY (
    ROWS, COLUMNS: INTEGER;
    VAR DISPLAY_ID: INTEGER;
    DISPLAY_ATTRIBUTES, VIDEO_ATTRIBUTES, CHAR_SET: UNSIGNED
    := %IMMED 0): UNSIGNED; EXTERN;

FUNCTION SMG$CREATE_PASTEBOARD (
    VAR PASTEBOARD_ID: INTEGER;
    OUTPUT_DEVICE: PACKED ARRAY [A..B:INTEGER] OF CHAR := %IMMED 0;
    ROWS, COLUMNS: INTEGER := %IMMED 0;
    PRESERVE_SCREEN_FLAG: BOOLEAN := %IMMED 0): UNSIGNED; EXTERN;

FUNCTION SMG$CREATE_VIRTUAL_KEYBOARD (
    VAR KEYBOARD_ID: INTEGER;
    FILESPEC: PACKED ARRAY [A..B:INTEGER] OF CHAR := %IMMED 0;
    DEFAULT_FILESPEC: PACKED ARRAY [C..D:INTEGER] OF CHAR := %IMMED 0;
    RESULTANT_FILESPEC: PACKED ARRAY [E..F:INTEGER] OF CHAR := %IMMED 0
    ): UNSIGNED; EXTERN;
```

(continued on next page)

Examples of Calling SMG\$ Routines

Example 7-7 (Cont.) Using SMG\$ Routines in Compaq Pascal

```
FUNCTION SMG$PASTE_VIRTUAL_DISPLAY (
    DISPLAY_ID, PASTEBOARD_ID: INTEGER;
    ROW, COLUMN: INTEGER): UNSIGNED; EXTERN;

FUNCTION SMG$READ_KEYSTROKE (
    KEYBOARD_ID: INTEGER;
    VAR TERMINATOR_CODE: UNSIGNED_WORD;
    PROMPT: PACKED ARRAY [A..B:INTEGER] OF CHAR := %IMMED 0;
    TIMEOUT, DISPLAY_ID: INTEGER := %IMMED 0): UNSIGNED; EXTERN;

FUNCTION SMG$PUT_LINE (
    DISPLAY_ID: INTEGER;
    TEXT: PACKED ARRAY [A..B:INTEGER] OF CHAR;
    LINE_ADVANCE: INTEGER := %IMMED 0;
    RENDITION_SET, RENDITION_COMPLEMENT: UNSIGNED := %IMMED 0;
    WRAP_FLAG: BOOLEAN := %IMMED 0;
    CHAR_SET: UNSIGNED := %IMMED 0): UNSIGNED; EXTERN;

var
    PASTEBOARD_1, DISPLAY_1, KEYBOARD_1: INTEGER;
    TERMINATOR: UNSIGNED_WORD;

BEGIN
    { Create virtual display, pasteboard and virtual keyboard }
    SMG$CREATE_VIRTUAL_DISPLAY (ROWS := 7, COLUMNS := 60,
        DISPLAY_ID := DISPLAY_1,
        DISPLAY_ATTRIBUTES := SMG$M_BORDER);
    SMG$CREATE_PASTEBOARD (PASTEBOARD_ID := PASTEBOARD_1);
    SMG$CREATE_VIRTUAL_KEYBOARD (KEYBOARD_ID := KEYBOARD_1);

    { Paste the virtual display at row 3, column 9 }
    SMG$PASTE_VIRTUAL_DISPLAY (DISPLAY_ID := DISPLAY_1,
        PASTEBOARD_ID := PASTEBOARD_1, ROW := 3, COLUMN := 9);

    { Write the instructions to the virtual display }
    SMG$PUT_LINE (DISPLAY_ID := DISPLAY_1,
        TEXT := 'Enter the character K after the >> prompt. ');
    SMG$PUT_LINE (DISPLAY_ID := DISPLAY_1,
        TEXT := 'This character will not be echoed as you type it. ');
    SMG$PUT_LINE (DISPLAY_ID := DISPLAY_1,
        TEXT := 'The terminal character equivalent of K is displayed. ');
    SMG$PUT_LINE (DISPLAY_ID := DISPLAY_1,
        TEXT := ' ');

    { Read the keystroke from the virtual keyboard }
    SMG$READ_KEYSTROKE (KEYBOARD_ID := KEYBOARD_1,
        DISPLAY_ID := DISPLAY_1,
        TERMINATOR_CODE := TERMINATOR, PROMPT := '>> ');

    { Display the decimal value of the terminator code }
    SMG$PUT_LINE (DISPLAY_ID := DISPLAY_1,
        TEXT := ' ');
    SMG$PUT_LINE (DISPLAY_ID := DISPLAY_1,
        TEXT := 'TERMINAL CHARACTER IS ' + DEC(TERMINATOR,5,1));
END.
```

Examples of Calling SMG\$ Routines

The program shown in Example 7–8 calls SMG\$READ_KEYSTROKE from VAX PL/I.

Example 7–8 Using SMG\$ Routines in VAX PL/I

```
/*
 * Example of SMG$READ_KEYSTROKE.
 */

/*
 * Declare the RTL entry points.
 */
declare
    SMG$CREATE_VIRTUAL_KEYBOARD external entry(
        fixed binary(31),      /* new-keyboard-id */
        character(*),         /* filespec */
        character(*),         /* default-filespec */
        character(*) varying ) /* resultant-filespec */
        returns(fixed binary(31)) options(variable);

declare
    SMG$DELETE_VIRTUAL_KEYBOARD external entry(
        fixed binary(31) )     /* keyboard-id */
        returns(fixed binary(31));

declare
    SMG$READ_KEYSTROKE external entry(
        fixed binary(31),      /* keyboard-id */
        fixed binary(15),      /* terminator-code */
        character(*),         /* prompt-string */
        fixed binary(31),      /* timeout */
        fixed binary(31) )     /* display-id */
        returns(fixed binary(31)) options(variable);

/*
 * Get the value of the SMG constants from PLISTARLET.
 */
#include $SMGDEF;
declare SMG$_EOF globalref value fixed binary(31);

/*
 * Misc. constants.
 */
%replace false by '0'b;
%replace true by '1'b;

/*
 * The following compile-time routine will signal an error at run-time
 * if the status value that it is passed does not have success or
 * informational severity (that is, if the low bit is not set).
 */
%signal_if: procedure (status_val) returns(character);
    %declare status_val character;
    %return( 'if posint(' || status_val || ',1,1) = 0 ' ||
        'then signal vaxcondition(' || status_val || ')' );
    %end;
```

(continued on next page)

Examples of Calling SMG\$ Routines

Example 7-8 (Cont.) Using SMG\$ Routines in VAX PL/I

```
main: proc options(main, ident('V4.2'));

    declare exit bit initial(false);
    declare status fixed binary(31);
    declare keyboard_id fixed binary(31);
    declare terminator fixed binary(15);

    /*
     * Create the virtual keyboard necessary for the read.
     */
    status = smg$create_virtual_keyboard( keyboard_id );
    signal_if( status );
    /*
     * Read a single keystroke. If that keystroke is an end-of-file,
     * then exit. Otherwise, SELECT the appropriate action based on
     * the key.
     */
    do while(^exit);

        status = smg$read_keystroke( keyboard_id, terminator,
            'Command: ', 20 );

        if status = SMG$_EOF
            then exit = true;

        else do;
            signal_if( status );
            select (terminator);

                when (SMG$K_TRM_PF2,
                    SMG$K_TRM_HELP,
                    rank('H'),
                    rank('h'),
                    rank('?') ) call display_help;

                when(SMG$K_TRM_DO) call do_command;
                when(rank('E'),
                    rank('e')) exit = true;

                otherwise      call command_error;

            end;
        end;

    /*
     * We're done, so delete the virtual keyboard.
     */
    status = smg$delete_virtual_keyboard( keyboard_id );
    signal_if( status );
end main;
```

(continued on next page)

Examples of Calling SMG\$ Routines

Example 7-8 (Cont.) Using SMG\$ Routines in VAX PL/I

```
display_help: procedure;
    put skip edit('This program uses single keystroke commands.') (A);
    put skip edit('The following keys are valid:') (A);
    put skip;
    put skip edit('      Key           Function') (A);
    put skip edit('      E/e           Exit') (A);
    put skip edit('      <DO>   Your choice...') (A);
    put skip edit('      ?/H/h/<HELP> Help') (A);
    put skip;
end display_help;

do_command: procedure;
    put skip edit('The DO key was pressed') (A);
    put skip;
end do_command;

command_error: procedure;
    put skip edit('The key pressed was not valid - please try again.') (A);
    put skip edit('(H for HELP).') (A);
    put skip;
end command_error;
```

Part II

SMG\$ Reference Section

This section contains detailed descriptions of all routines provided by the RTL Screen Management (SMG\$) Facility.

SMG\$ADD_KEY_DEF

Add Key Definition

The Add Key Definition routine adds a keypad key definition to a table of key definitions.

Format

```
SMG$ADD_KEY_DEF key-table-id ,key-name [,if-state] [,attributes]
                [,equivalence-string] [,state-string]
```

Returns

OpenVMS usage: cond_value
 type: longword (unsigned)
 access: write only
 mechanism: by value

Arguments

key-table-id

OpenVMS usage: identifier
 type: longword (unsigned)
 access: read only
 mechanism: by reference

Identifies the key table to which you are adding a key definition. The **key-table-id** argument is the address of an unsigned longword that contains the key table identifier.

The key table identifier argument is returned by the SMG\$CREATE_KEY_TABLE routine.

key-name

OpenVMS usage: char_string
 type: character string
 access: read only
 mechanism: by descriptor

Identifies the key whose value you are defining. The **key-name** argument is the address of a descriptor pointing to this key name. The SMG\$ADD_KEY_DEF routine changes the string to uppercase and removes trailing blanks.

Table 3–1 lists the valid key names.

if-state

OpenVMS usage: char_string
 type: character string
 access: read only
 mechanism: by descriptor

Qualifies the value returned when **key-name** is pressed. The **if-state** argument is the address of a descriptor pointing to the state string.

SMG\$ Routines

SMG\$ADD_KEY_DEF

If **if-state** is specified, this definition of **key-name** is used only if the current state matches the specified **if-state** string. The **if-state** argument must be from 1 to 31 characters in length. If this argument is omitted, **if-state** defaults to the value DEFAULT.

attributes

OpenVMS usage: mask_longword
type: longword (unsigned)
access: read only
mechanism: by reference

Longword bit mask specifying additional attributes of this key definition. The **attributes** argument is the address of an unsigned longword that contains this attribute mask. If omitted, the mask is zero.

Valid **attributes** are described in the following list:

| | |
|----------------------|--|
| SMG\$M_KEY_NOECHO | If set, this bit specifies that equivalence-string is not to be echoed when this key is pressed. If clear, equivalence-string is echoed. If SMG\$M_KEY_TERMINATE is not set, SMG\$M_KEY_NOECHO is ignored. |
| SMG\$M_KEY_TERMINATE | If set, this bit specifies that when this key is pressed (as qualified by if-state) the input line is complete and more characters should not be accepted. If clear, more characters may be accepted. In other words, setting this bit causes equivalence-string to be treated as a terminator. |
| SMG\$M_KEY_LOCK | If set, and if state-string is specified, the state name specified by state-string remains the current state until explicitly changed by a subsequent keystroke whose definition includes a state-string . If clear, the state name specified by state-string remains in effect only for the next defined keystroke. |
| SMG\$M_KEY_PROTECTED | If set, this bit specifies that this key definition cannot be modified or deleted. If clear, the key definition can be modified or deleted. |

The remaining bits are undefined and must be zero. It is possible to perform a logical OR operation on these values to set more than one attribute at a time.

equivalence-string

OpenVMS usage: char_string
type: character string
access: read only
mechanism: by descriptor

Character string to be substituted for the keystroke in the returned line. The **equivalence-string** argument is the address of a descriptor pointing to this equivalence string.

The **equivalence-string** argument is displayed unless SMGSM_KEY_NOECHO is set. If **equivalence-string** is omitted, no equivalence string is defined for this key.

state-string

OpenVMS usage: char_string
 type: character string
 access: read only
 mechanism: by descriptor

Contains a new state name that becomes the current state when this key is pressed. The **state-string** argument is the address of a descriptor pointing to the new state string.

If omitted, no new state is defined. If the current state is temporary (that is, if SMGSM_KEY_LOCKSTATE was not specified for the most recently pressed defined key), the current **state-string** becomes DEFAULT.

Description

SMG\$ADD_KEY_DEF inserts a key definition into a key definition table. The table must have been created with a call to SMG\$CREATE_KEY_TABLE. After SMG\$ADD_KEY_DEF executes, the specified equivalence string is returned when the user types the specified key in response to the SMG\$READ_COMPOSED_LINE routine.

You can define all keys on the VT100, VT200-series, VT300-series, VT400-series, and VT500-series keyboards and keypads.

Condition Values Returned

| | |
|-----------------|---|
| SS\$_NORMAL | Normal successful completion. |
| SMG\$_PREDEFREP | Successful completion. The previous key definition has been replaced. |
| SMG\$_INVDEFATT | Invalid key definition attributes. |
| SMG\$_INVKEYNAM | Invalid key-name . |
| SMG\$_INVKTB_ID | Invalid key-table-id . |
| SMG\$_KEYDEFPRO | Key definition is protected against change or deletion. |
| SMG\$_WRONUMARG | Wrong number of arguments. |

Any condition values returned by LIB\$SCOPY_DXDX.

SMG\$ Routines

SMG\$BEGIN_DISPLAY_UPDATE

SMG\$BEGIN_DISPLAY_UPDATE

Begin Batching of Display Updates

The Begin Batching of Display Updates routine saves, or batches, all output to a virtual display until a matching call to SMG\$END_DISPLAY_UPDATE is encountered.

Format

SMG\$BEGIN_DISPLAY_UPDATE display-id

Returns

OpenVMS usage: cond_value
type: longword (unsigned)
access: write only
mechanism: by value

Argument

display-id
OpenVMS usage: identifier
type: longword (unsigned)
access: read only
mechanism: by reference

Specifies the virtual display for which output is to be batched. The **display-id** argument is the address of an unsigned longword that contains the display identifier.

The display identifier is returned by SMG\$CREATE_VIRTUAL_DISPLAY.

Description

SMG\$BEGIN_DISPLAY_UPDATE lets you make more than one change to a display and have the changes appear only after all changes are complete. Thus, the user sees the display change from its initial state to its final state, without seeing any of the intermediate states.

Batching terminates when SMG\$END_DISPLAY_UPDATE has been called the same number of times for a given display as has SMG\$BEGIN_DISPLAY_UPDATE. The Screen Management Facility keeps track of batching for a given display; thus, the calls to the SMG\$BEGIN_DISPLAY_UPDATE and SMG\$END_DISPLAY_UPDATE need not occur in the same module.

Condition Values Returned

| | |
|-----------------|---|
| SS\$NORMAL | Normal successful completion. |
| SMG\$_BATWAS_ON | Successful completion; batching has already been initiated. |
| SMG\$_INVDIS_ID | Invalid display-id . |
| SMG\$_WRONUMARG | Wrong number of arguments. |

SMG\$BEGIN_PASTEBOARD_UPDATE

Begin Batching of Pasteboard Updates

The Begin Batching of Pasteboard Updates routine saves, or batches, all output to a pasteboard until a matching call to SMG\$END_PASTEBOARD_UPDATE is encountered.

Format

SMG\$BEGIN_PASTEBOARD_UPDATE pasteboard-id

Returns

OpenVMS usage: cond_value
type: longword (unsigned)
access: write only
mechanism: by value

Argument

pasteboard-id
OpenVMS usage: identifier
type: longword (unsigned)
access: read only
mechanism: by reference

Specifies the pasteboard for which output is to be batched. The **pasteboard-id** argument is the address of an unsigned longword that contains the pasteboard identifier.

The pasteboard identifier is returned by SMG\$CREATE_PASTEBOARD.

Description

SMG\$BEGIN_PASTEBOARD_UPDATE lets you make more than one change to a pasteboard and have the changes appear only after all changes are complete. Thus, the user sees the pasteboard change from its initial state to its final state, without seeing any of the intermediate states.

Batching terminates when SMG\$END_PASTEBOARD_UPDATE has been called the same number of times for a given pasteboard as has SMG\$BEGIN_PASTEBOARD_UPDATE. The Screen Management Facility keeps track of batching for a given pasteboard; thus, the calls to the SMG\$BEGIN_PASTEBOARD_UPDATE and SMG\$END_PASTEBOARD_UPDATE need not occur in the same module.

Condition Values Returned

| | |
|----------------|---|
| SS\$NORMAL | Normal successful completion. |
| SMG\$BATWAS_ON | Successful completion; batching has already been initiated. |
| SMG\$INVPAS_ID | Invalid pasteboard-id . |
| SMG\$WRONUMARG | Wrong number of arguments. |

SMG\$ Routines

SMG\$CANCEL_INPUT

SMG\$CANCEL_INPUT

Cancel Input Request

The Cancel Input Request routine immediately cancels any read-in-progress that was issued by SMG\$READ_COMPOSED_LINE, SMG\$READ_KEYSTROKE, SMG\$READ_STRING, or SMG\$READ_VERIFY.

Format

SMG\$CANCEL_INPUT keyboard-id

Returns

OpenVMS usage: cond_value
type: longword (unsigned)
access: write only
mechanism: by value

Argument

keyboard-id
OpenVMS usage: identifier
type: longword (unsigned)
access: read only
mechanism: by reference

Specifies the virtual keyboard for which the input is to be canceled. The **keyboard-id** argument is the address of an unsigned longword that contains the keyboard identifier.

The keyboard identifier is returned by SMG\$CREATE_VIRTUAL_KEYBOARD.

Description

SMG\$CANCEL_INPUT causes immediate termination of an SMG\$READ_COMPOSED_LINE, SMG\$READ_KEYSTROKE, SMG\$READ_STRING, or SMG\$READ_VERIFY input operation from a terminal. The condition code SSS_CANCEL or SSS_ABORT is returned to those routines when you use SMG\$CANCEL_INPUT. Note that if the specified virtual keyboard is associated with an OpenVMS RMS file, this procedure has no effect because it is not possible to cancel an outstanding RMS input operation.

Condition Values Returned

| | |
|-----------------|-------------------------------|
| SSS_NORMAL | Normal successful completion. |
| SMG\$_INVKBD_ID | Invalid keyboard-id . |
| SMG\$_WRONUMARG | Wrong number of arguments. |

SMG\$CHANGE_PBD_CHARACTERISTICS

Change Pasteboard Characteristics

The Change Pasteboard Characteristics routine lets you change the characteristics associated with a pasteboard.

Format

```
SMG$CHANGE_PBD_CHARACTERISTICS  pasteboard-id [,desired-width]
                                   [,width] [,desired-height] [,height]
                                   [,desired-background-color]
                                   [,background-color]
```

Returns

OpenVMS usage: cond_value
type: longword (unsigned)
access: write only
mechanism: by value

Arguments

pasteboard-id

OpenVMS usage: identifier
type: longword (unsigned)
access: read only
mechanism: by reference

Specifies the pasteboard whose characteristics are to be changed. The **pasteboard-id** argument is the address of an unsigned longword that contains the pasteboard identifier.

The pasteboard identifier is returned by SMG\$CREATE_PASTEBOARD.

desired-width

OpenVMS usage: longword_signed
type: longword (signed)
access: read only
mechanism: by reference

New width for the pasteboard. The **desired-width** argument is the address of a signed longword that contains the desired width. If omitted, the width does not change.

width

OpenVMS usage: longword_signed
type: longword (signed)
access: write only
mechanism: by reference

Receives the physical width of the pasteboard. The **width** argument is the address of a signed longword into which is written the actual width of the pasteboard.

If the terminal cannot be set exactly to **desired-width**, **width** may be larger than **desired-width**. If the physical width of the terminal is smaller than **desired-width**, **width** may be smaller than **desired-width**.

SMG\$ Routines

SMG\$CHANGE_PBD_CHARACTERISTICS

desired-height

OpenVMS usage: longword_signed
type: longword (signed)
access: read only
mechanism: by reference

New height for the pasteboard. The **desired-height** argument is the address of a signed longword that contains the desired height of the pasteboard. If **desired-height** is omitted, the height does not change.

height

OpenVMS usage: longword_signed
type: longword (signed)
access: write only
mechanism: by reference

Receives the physical height of the pasteboard. The **height** argument is the address of a signed longword into which is written the actual height of the pasteboard.

If the terminal cannot be set exactly to **desired-height**, **height** may be larger than **desired-height**. If the physical height of the terminal is smaller than **desired-height**, **height** may be smaller than **desired-height**.

desired-background-color

OpenVMS usage: longword_unsigned
type: longword (unsigned)
access: read only
mechanism: by reference

Symbolic name for the desired background color. The **desired-background-color** argument is the address of an unsigned longword that contains the desired color.

The symbols listed below are defined in \$SMGDEF. Valid values for **desired-background-color** are as follows:

| | |
|----------------------|------------------------------|
| SMG\$C_COLOR_WHITE | Light background |
| SMG\$C_COLOR_BLACK | Dark background |
| SMG\$C_COLOR_BLUE | Blue background |
| SMG\$C_COLOR_CYAN | Cyan (green-blue) background |
| SMG\$C_COLOR_GREEN | Green background |
| SMG\$C_COLOR_MAGENTA | Magenta background |
| SMG\$C_COLOR_RED | Red background |
| SMG\$C_COLOR_YELLOW | Yellow background |
| SMG\$C_COLOR_LIGHT | White background |
| SMG\$C_COLOR_DARK | Black background |
| SMG\$C_COLOR_USER1 | User-defined background 1 |
| SMG\$C_COLOR_USER2 | User-defined background 2 |
| SMG\$C_COLOR_USER3 | User-defined background 3 |
| SMG\$C_COLOR_USER4 | User-defined background 4 |
| SMG\$C_COLOR_USER5 | User-defined background 5 |

SMG\$ Routines SMG\$CHANGE_PBD_CHARACTERISTICS

| | |
|--------------------|---------------------------|
| SMG\$C_COLOR_USER6 | User-defined background 6 |
| SMG\$C_COLOR_USER7 | User-defined background 7 |
| SMG\$C_COLOR_USER8 | User-defined background 8 |

If you omit **desired-background-color**, or if the terminal hardware does not support the background color specified, the background color is not changed.

background-color

OpenVMS usage: longword_unsigned
type: longword (unsigned)
access: write only
mechanism: by reference

Receives the background color chosen. The **background-color** argument is the address of an unsigned longword into which is written the background color.

This routine may return any of the values listed in the **desired-background-color** argument description or SMG\$C_COLOR_UNKNOWN. If the **desired-background-color** argument is omitted, the value of **background-color** does not change.

Description

SMG\$CHANGE_PBD_CHARACTERISTICS lets you change the width, height, and background color associated with a pasteboard.

If necessary, this routine will notify the OpenVMS operating system of the change in pasteboard characteristics by updating the terminal characteristics displayed when you enter the DCL command SHOW TERMINAL.

Do not use SMG\$CHANGE_PBD_CHARACTERISTICS on a batched pasteboard.

Condition Values Returned

| | |
|-----------------|---|
| SS\$_NORMAL | Normal successful completion. |
| SMG\$_INVCOLARG | Unknown background color specified. |
| SMG\$_INVPAGARG | Invalid height of 0 desired. |
| SMG\$_INVWIDARG | Invalid width of 0 desired. |
| SMG\$_PBDIN_USE | Cannot change characteristics while batching is on. |
| SMG\$_WRONUMARG | Wrong number of arguments. |
| SS\$_xxx | Any error from \$QIOW. |

SMG\$CHANGE_RENDITION

Change Default Rendition

The Change Default Rendition routine changes the video attributes for all or part of a virtual display.

Format

SMG\$CHANGE_RENDITION display-id ,start-row ,start-column ,number-of-rows
,number-of-columns [,rendition-set]
[,rendition-complement]

Returns

OpenVMS usage: cond_value
type: longword (unsigned)
access: write only
mechanism: by value

Arguments

display-id

OpenVMS usage: identifier
type: longword (unsigned)
access: read only
mechanism: by reference

Specifies the virtual display whose default rendition is to be changed. The **display-id** argument is the address of an unsigned longword that contains the display identifier.

The display identifier is returned by SMG\$CREATE_VIRTUAL_DISPLAY.

start-row

OpenVMS usage: longword_signed
type: longword (signed)
access: read only
mechanism: by reference

Starting row position to receive the new rendition. The **start-row** argument is the address of a signed longword that contains the starting row number.

start-column

OpenVMS usage: longword_signed
type: longword (signed)
access: read only
mechanism: by reference

Starting column position to receive the new rendition. The **start-column** argument is the address of a signed longword that contains the starting column number.

number-of-rows

OpenVMS usage: longword_signed
type: longword (signed)
access: read only
mechanism: by reference

Number of rows to receive the new rendition. The **number-of-rows** argument is the address of a signed longword that contains the number of rows to be affected.

number-of-columns

OpenVMS usage: longword_signed
type: longword (signed)
access: read only
mechanism: by reference

Number of columns to receive the new rendition. The **number-of-columns** argument is the address of a signed longword that contains the number of columns to be affected.

rendition-set

OpenVMS usage: mask_longword
type: longword (unsigned)
access: read only
mechanism: by reference

Attribute specifier. The optional **rendition-set** argument is the address of a longword bit mask in which each attribute set causes the corresponding attribute to be set in the display. The following attributes can be specified using the **rendition-set** argument:

| | |
|---|---|
| SMG\$M_BLINK | Displays blinking characters. |
| SMG\$M_BOLD | Displays characters in higher-than-normal intensity. |
| SMG\$M_REVERSE | Displays characters in reverse video; that is, using the opposite of the default rendition of the virtual display. |
| SMG\$M_UNDERLINE | Displays underlined characters. |
| SMG\$M_INVISIBLE | Specifies invisible characters; that is, the characters exist in the virtual display but do not appear on the pasteboard. |
| SMG\$M_USER1 through SMG\$M_USER8 | Displays user-defined attributes. |

The **display-id** argument must be specified when you use the **rendition-set** argument.

rendition-complement

OpenVMS usage: mask_longword
type: longword (unsigned)
access: read only
mechanism: by reference

Attribute complement specifier. The optional **rendition-complement** argument is the address of a longword bit mask in which each attribute set causes the corresponding attribute to be complemented in the display. All of the attributes that can be specified with the **rendition-set** argument can be complemented

SMG\$ Routines

SMG\$CHANGE_RENDITION

with the **rendition-complement** argument. The **display-id** argument must be specified when you use the **rendition-complement** argument.

The optional arguments **rendition-set** and **rendition-complement** let the user control the attributes of the virtual display. The **rendition-set** argument sets certain virtual display attributes, while **rendition-complement** complements these attributes. If the same bit is specified in both the **rendition-set** and **rendition-complement** parameters, **rendition-set** is evaluated first, followed by **rendition-complement**. By using these two parameters together, the user can control each virtual display attribute in a single procedure call. On a single-attribute basis, the user can cause the following transformations:

| Set | Complement | Action |
|-----|------------|--|
| 0 | 0 | Attribute set to default |
| 1 | 0 | Attribute on |
| 0 | 1 | Attribute set to complement of default setting |
| 1 | 1 | Attribute off |

Description

This procedure changes the default video rendition of a rectangular block of text already in the specified virtual display. For example, you might use this procedure to redisplay a particular row in reverse video.

Condition Values Returned

| | |
|-----------------|--|
| SS\$_NORMAL | Normal successful completion. |
| SMG\$_INVARG | Invalid number of rows, invalid number of columns, unrecognized rendition-set code, or unrecognized rendition-complement code. |
| SMG\$_INVCOL | Invalid start-column . The specified column is outside the virtual display. |
| SMG\$_INVDIS_ID | Invalid display-id . |
| SMG\$_INVROW | Invalid start-row . The specified row is outside the virtual display. |
| SMG\$_NO_CHADIS | No change in virtual display. |
| SMG\$_WRONUMARG | Wrong number of arguments. |

SMG\$CHANGE_VIEWPORT

Change the Viewport Associated with a Virtual Display

The Change the Viewport Associated with a Virtual Display routine changes the size of an existing viewport in a virtual display. The text currently in the viewport is remapped to fit the new dimensions.

Format

```
SMG$CHANGE_VIEWPORT display-id [,viewport-row-start] [,viewport-column-start]
                    [,viewport-number-rows] [,viewport-number-columns]
```

Returns

OpenVMS usage: cond_value
type: longword (unsigned)
access: write only
mechanism: by value

Arguments

display-id

OpenVMS usage: identifier
type: longword (unsigned)
access: read only
mechanism: by reference

Identifier of the virtual display containing the viewport to be changed. The **display-id** argument is the address of an unsigned longword containing this identifier.

viewport-row-start

OpenVMS usage: longword_signed
type: longword (signed)
access: read only
mechanism: by reference

Optional row number in the virtual display that will become row 1 in the changed viewport. The **viewport-row-start** argument is the address of a signed longword containing the row number. If omitted, the present **viewport-row-start** value is used.

viewport-column-start

OpenVMS usage: longword_signed
type: longword (signed)
access: read only
mechanism: by reference

Optional column number in the virtual display that will become column 1 in the changed viewport. The **viewport-column-start** argument is the address of a signed longword containing the column number. If omitted, the present **viewport-column-start** value is used.

SMG\$ Routines

SMG\$CHANGE_VIEWPORT

viewport-number-rows

OpenVMS usage: longword_signed
type: longword (signed)
access: read only
mechanism: by reference

Optional number of rows in the changed viewport. The **viewport-number-rows** argument is the address of a signed longword containing the number of rows. If omitted, the present **viewport-number-rows** value is used.

viewport-number-columns

OpenVMS usage: longword_signed
type: longword (signed)
access: read only
mechanism: by reference

Optional number of columns in the changed viewport. The **viewport-number-columns** argument is the address of a signed longword containing the number of columns. If omitted, the present **viewport-number-columns** value is used.

Description

SMG\$CHANGE_VIEWPORT lets you change the size of an existing viewport in a virtual display. The text currently in this viewport is remapped to fit the new dimensions, starting at the position specified by the **viewport-row-start** and **viewport-column-start** arguments. This position also specifies the resulting virtual cursor location.

Condition Values Returned

| | |
|--------------------|--|
| SS\$ _NORMAL | Normal successful completion. |
| SMG\$ _INVARG | Number of rows or columns is less than zero. |
| SMG\$ _INVCOL | Invalid column specified. |
| SMG\$ _INVDIS_ID | Invalid display-id . |
| SMG\$ _INVROW | Invalid row specified. |
| SMG\$ _NO_WINASSOC | No viewport associated with the virtual display. |
| SMG\$ _WRONUMARG | Wrong number of arguments. |

Example

```
C+
C This Fortran example program demonstrates the use of
C SMG$CHANGE_VIEWPORT.
C-

    IMPLICIT INTEGER (A-Z)
    INCLUDE '($SMGDEF)'

C Create the virtual display. Give it a border.

    ROWS = 9
    COLUMNS = 50

    STATUS = SMG$CREATE_VIRTUAL_DISPLAY
             1 (ROWS, COLUMNS, DISPLAY1, SMG$M_BORDER )
    IF (.NOT. STATUS) CALL LIB$SIGNAL(%val(STATUS))

C Create the pasteboard.
```

SMG\$ Routines SMG\$CHANGE_VIEWPORT

```
STATUS = SMG$CREATE_PASTEBOARD (PASTE1)
IF (.NOT. STATUS) CALL LIB$SIGNAL(%VAL(STATUS))

C Put data in the virtual display.

STATUS = SMG$PUT_CHARS ( DISPLAY1,
1 'This is row 1 in a virtual display with 9 rows.',1,1)
IF (.not. STATUS) CALL LIB$SIGNAL(%VAL(STATUS))

STATUS = SMG$PUT_CHARS ( DISPLAY1,
1 'This is row 2 in a virtual display with 9 rows.',2,1)
IF (.not. STATUS) CALL LIB$SIGNAL(%VAL(STATUS))

STATUS = SMG$PUT_CHARS ( DISPLAY1,
1 'This is row 3 in a virtual display with 9 rows.',3,1)
IF (.not. STATUS) CALL LIB$SIGNAL(%VAL(STATUS))

STATUS = SMG$PUT_CHARS ( DISPLAY1,
1 'This is row 4 in a virtual display with 9 rows.',4,1)
IF (.not. STATUS) CALL LIB$SIGNAL(%VAL(STATUS))

STATUS = SMG$PUT_CHARS ( DISPLAY1,
1 'This is row 5 in a virtual display with 9 rows.',5,1)
IF (.not. STATUS) CALL LIB$SIGNAL(%VAL(STATUS))

STATUS = SMG$PUT_CHARS ( DISPLAY1,
1 'This is row 6 in a virtual display with 9 rows.',6,1)
IF (.not. STATUS) CALL LIB$SIGNAL(%VAL(STATUS))

STATUS = SMG$PUT_CHARS ( DISPLAY1,
1 'This is row 7 in a virtual display with 9 rows.',7,1)
IF (.not. STATUS) CALL LIB$SIGNAL(%VAL(STATUS))

STATUS = SMG$PUT_CHARS ( DISPLAY1,
1 'This is row 8 in a virtual display with 9 rows.',8,1)
IF (.not. STATUS) CALL LIB$SIGNAL(%VAL(STATUS))

STATUS = SMG$PUT_CHARS ( DISPLAY1,
1 'This is row 9 in a virtual display with 9 rows.',9,1)
IF (.not. STATUS) CALL LIB$SIGNAL(%VAL(STATUS))

C Paste the virtual display.

STATUS = SMG$COPY_VIRTUAL_DISPLAY(DISPLAY1,DISPLAY2)
IF (.NOT. STATUS) CALL LIB$SIGNAL(%VAL(STATUS))

STATUS = SMG$LABEL_BORDER (DISPLAY1, 'Full Display',,,SMG$M_BOLD)
IF (.NOT. STATUS) CALL LIB$SIGNAL(%VAL(STATUS))

STATUS = SMG$LABEL_BORDER (DISPLAY2, 'Viewport',,,SMG$M_BOLD)
IF (.NOT. STATUS) CALL LIB$SIGNAL(%VAL(STATUS))

STATUS = SMG$PASTE_VIRTUAL_DISPLAY ( DISPLAY1, PASTE1, 2, 10)
IF (.NOT. STATUS) CALL LIB$SIGNAL(%VAL(STATUS))

STATUS = SMG$PASTE_VIRTUAL_DISPLAY ( DISPLAY2, PASTE1, 13, 10)
IF (.NOT. STATUS) CALL LIB$SIGNAL(%VAL(STATUS))
CALL LIB$WAIT (4.0)

STATUS = SMG$CREATE_VIEWPORT ( DISPLAY2, 2, 1, 5, 21)
IF (.NOT. STATUS) CALL LIB$SIGNAL(%VAL(STATUS))
CALL LIB$WAIT (4.0)

STATUS = SMG$PASTE_VIRTUAL_DISPLAY ( DISPLAY2, PASTE1, 13, 10)
IF (.NOT. STATUS) CALL LIB$SIGNAL(%VAL(STATUS))
CALL LIB$WAIT (4.0)

STATUS = SMG$CHANGE_VIEWPORT ( DISPLAY2, 4, 8, 3, 15)
IF (.NOT. STATUS) CALL LIB$SIGNAL(%VAL(STATUS))
call lib$wait (4.0)

END
```

SMG\$ Routines

SMG\$CHANGE_VIEWPORT

The output generated by this Fortran example is shown in the following figures. In Figure SMG-1, the program has copied the initial virtual display into a second virtual display, labeled "Viewport."

Figure SMG-1 Output Generated After Virtual Displays Are Pasted

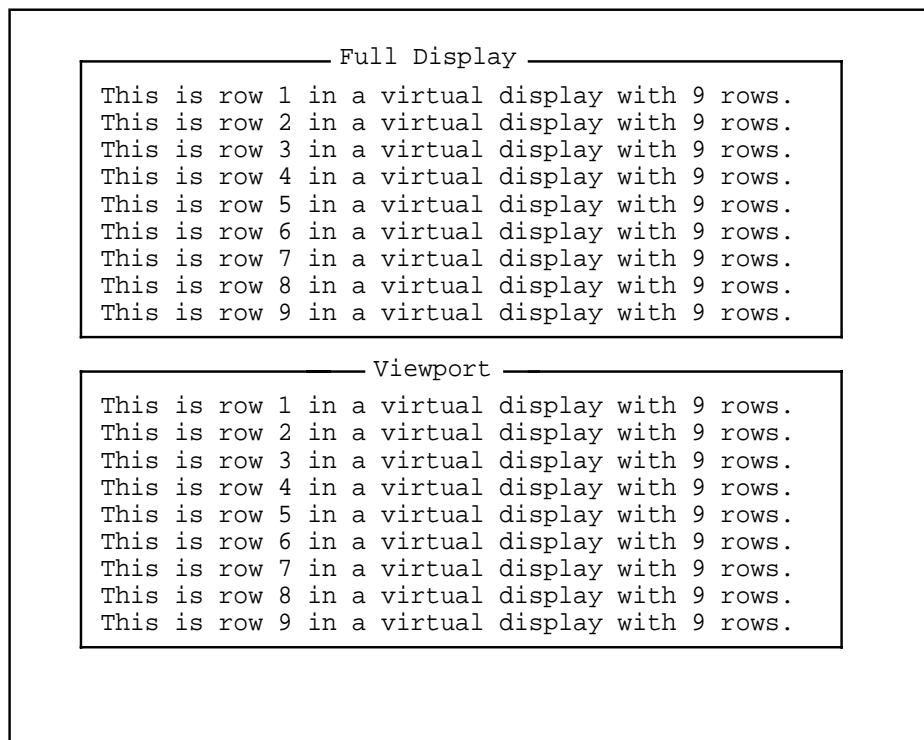

```
----- Full Display -----
This is row 1 in a virtual display with 9 rows.
This is row 2 in a virtual display with 9 rows.
This is row 3 in a virtual display with 9 rows.
This is row 4 in a virtual display with 9 rows.
This is row 5 in a virtual display with 9 rows.
This is row 6 in a virtual display with 9 rows.
This is row 7 in a virtual display with 9 rows.
This is row 8 in a virtual display with 9 rows.
This is row 9 in a virtual display with 9 rows.

----- Viewport -----
This is row 1 in a virtual display with 9 rows.
This is row 2 in a virtual display with 9 rows.
This is row 3 in a virtual display with 9 rows.
This is row 4 in a virtual display with 9 rows.
This is row 5 in a virtual display with 9 rows.
This is row 6 in a virtual display with 9 rows.
This is row 7 in a virtual display with 9 rows.
This is row 8 in a virtual display with 9 rows.
This is row 9 in a virtual display with 9 rows.
```

ZK-6423/1-GE

After the two identical virtual displays are pasted, the program creates a viewport on the second (copy) virtual display. Once the second display is "repasted," only the portion located in the viewport is visible. This is shown in Figure SMG-2.

Figure SMG-2 Output Generated After the Viewport Is Created

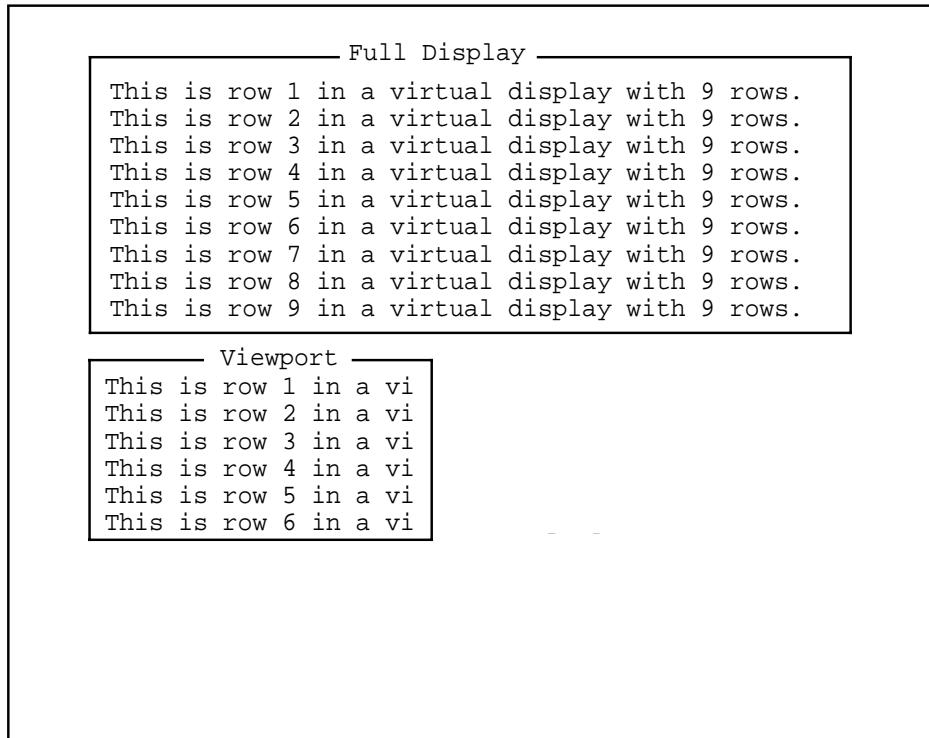

ZK-6423/2-GE

By calling SMG\$CHANGE_VIEWPORT, the portion of the virtual display that is visible through the viewport is changed. This is shown in Figure SMG-3.

SMG\$ Routines
SMG\$CHANGE_VIEWPORT

Figure SMG-3 Output Generated After Calling SMG\$CHANGE_VIEWPORT

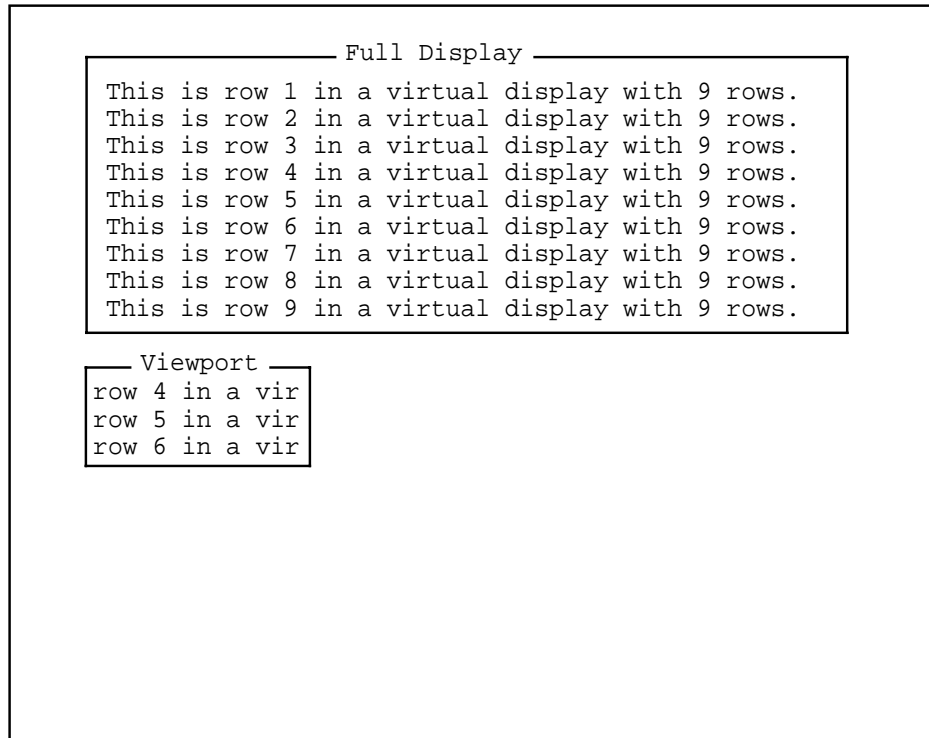

ZK-6423/3-GE

SMG\$CHANGE_VIRTUAL_DISPLAY

Change Virtual Display

The Change Virtual Display routine lets you change the dimensions, border, and video attributes of a virtual display.

Format

```
SMG$CHANGE_VIRTUAL_DISPLAY display-id [,number-of-rows]
                             [,number-of-columns] [,display-attributes]
                             [,video-attributes] [,character-set]
```

Returns

OpenVMS usage: cond_value
type: longword (unsigned)
access: write only
mechanism: by value

Arguments

display-id

OpenVMS usage: identifier
type: longword (unsigned)
access: read only
mechanism: by reference

Specifies the virtual display whose attributes are to be changed. The **display-id** argument is the address of an unsigned longword that contains the display identifier.

The display identifier is returned by SMG\$CREATE_VIRTUAL_DISPLAY.

number-of-rows

OpenVMS usage: longword_signed
type: longword (signed)
access: read only
mechanism: by reference

Specifies the new number of rows for the virtual display. The **number-of-rows** argument is the address of a signed longword that contains the number of rows in the virtual display.

number-of-columns

OpenVMS usage: longword_signed
type: longword (signed)
access: read only
mechanism: by reference

Specifies the new number of columns for the virtual display. The **number-of-columns** argument is the address of a signed longword that contains the number of columns in the virtual display.

SMG\$ Routines

SMG\$CHANGE_VIRTUAL_DISPLAY

display-attributes

OpenVMS usage: mask_longword
type: longword (unsigned)
access: read only
mechanism: by reference

Specifies the attributes of the virtual display. The **display-attributes** argument is the address of a longword bit mask that contains the display attributes.

Valid values for **display-attributes** are as follows:

| | |
|-------------------------|---|
| SMG\$M_BORDER | Specifies a bordered display. If omitted, the display is not bordered. |
| SMG\$M_BLOCK_BORDER | Specifies a block bordered display. If omitted, the display is not bordered. |
| SMG\$M_DISPLAY_CONTROLS | Specifies that control characters such as carriage return and line feed are displayed as graphic characters, if your terminal supports them. |
| SMG\$M_TRUNC_ICON | Specifies that an icon (generally a diamond shape) is displayed where truncation of a line exceeding the width of the virtual display has occurred. |

video-attributes

OpenVMS usage: mask_longword
type: longword (unsigned)
access: read only
mechanism: by reference

Specifies the default rendition to be applied to all output in a virtual display, unless overridden by a call to a specific output routine. The **video-attributes** argument is the address of an unsigned longword that contains the video attributes mask.

For example, a call to SMG\$PUT_CHARS with an explicit rendition specified would override the default rendition.

The bits that can be set for this argument are as follows:

| | |
|-----------------------------------|---|
| SMG\$M_BLINK | Displays blinking characters. |
| SMG\$M_BOLD | Displays characters in higher-than-normal intensity. |
| SMG\$M_REVERSE | Displays characters in reverse video; that is, to the opposite of the current default rendition of the virtual display. |
| SMG\$M_UNDERLINE | Displays underlined characters. |
| SMG\$M_INVISIBLE | Specifies invisible characters; that is, the characters exist in the virtual display but do not appear on the pasteboard. |
| SMG\$M_USER1 through SMG\$M_USER8 | Displays user-defined attributes. |

You can specify any combination of attributes in a single call. All other bits are reserved for use by Compaq and must be 0.

character-set

OpenVMS usage: longword_unsigned
type: longword (unsigned)
access: read only
mechanism: by reference

Specifies the default character set for all text in this virtual display. The **character-set** argument is the address of an unsigned longword that contains the character set specifier. Valid values are SMG\$C_ASCII (the default), and SMG\$C_SPEC_GRAPHICS.

Description

SMG\$CHANGE_VIRTUAL_DISPLAY lets you change the size or default attributes of an existing virtual display. If the size of the virtual display is changed, the Screen Management Facility attempts to remap the text associated with the display to fit the new dimensions (starting at row 1 and column 1). If the new size of the virtual display is smaller than the old size, text may be truncated. If the new size of the virtual display is larger than the old size, text may be padded on the right with spaces.

When a display is redimensioned, the virtual cursor for the display is moved to row 1 and column 1. If a labeled border applies to the virtual display and does not fit the redimensioned display, the label is deleted.

If a program calls both SMG\$CREATE_PASTEBOARD and SMG\$CREATE_VIRTUAL_KEYBOARD, make sure SMG\$CREATE_PASTEBOARD is called first. The program will not function correctly if SMG\$CREATE_VIRTUAL_KEYBOARD is called before SMG\$CREATE_PASTEBOARD.

Condition Values Returned

| | |
|----------------|---|
| SS\$NORMAL | Normal successful completion. |
| LIB\$INSVIRMEM | Insufficient virtual memory to reallocate needed buffers. |
| SMG\$INVARG | Invalid video or display attributes. |
| SMG\$INVDIS_ID | Invalid display-id . |
| SMG\$WRONUMARG | Wrong number of arguments. |

SMG\$ Routines

SMG\$CHECK_FOR_OCCLUSION

SMG\$CHECK_FOR_OCCLUSION

Check for Occlusion

The Check for Occlusion routine checks to see whether a virtual display is covered (occluded) by another virtual display.

Format

SMG\$CHECK_FOR_OCCLUSION display-id ,pasteboard-id ,occlusion-state

Returns

OpenVMS usage: cond_value
type: longword (unsigned)
access: write only
mechanism: by value

Arguments

display-id

OpenVMS usage: identifier
type: longword (unsigned)
access: read only
mechanism: by reference

Specifies the virtual display to be checked. The **display-id** argument is the address of an unsigned longword that contains the display identifier.

The display identifier is returned by SMG\$CREATE_VIRTUAL_DISPLAY.

pasteboard-id

OpenVMS usage: identifier
type: longword (unsigned)
access: read only
mechanism: by reference

Specifies the pasteboard to be checked. The **pasteboard-id** argument is the address of an unsigned longword that contains the pasteboard identifier.

The pasteboard identifier is returned by SMG\$CREATE_PASTEBOARD.

occlusion-state

OpenVMS usage: longword_signed
type: longword (signed)
access: write only
mechanism: by reference

Receives the value denoting whether the display is occluded. The **occlusion-state** argument is the address of a signed longword into which the occlusion state is written. **Occlusion-state** is set to 1 if the display is occluded or set to 0 if the display is not occluded on the specified pasteboard. If the procedure does not return SSS_NORMAL, the contents of **occlusion-state** are undefined.

Description

SMG\$CHECK_FOR_OCCLUSION determines whether a specified virtual display as pasted to the specified pasteboard is occluded, or covered, by another virtual display.

Condition Values Returned

| | |
|------------------|--|
| SS\$ _NORMAL | Normal successful completion. |
| SMG\$ _INVDIS_ID | Invalid display-id . |
| SMG\$ _INVPAS_ID | Invalid pasteboard-id . |
| SMG\$ _NOTPASTED | Specified virtual display is not pasted to the specified pasteboard. |
| SMG\$ _WRONUMARG | Wrong number of arguments. |

Example

```

C+
C This Fortran example program demonstrates the use of
C SMG$CHECK_FOR_OCCLUSION.
C
C This routine creates a virtual display and writes it to the
C pasteboard. Data is placed in the virtual display using SMG$PUT_CHARS.
C-

      INTEGER SMG$CREATE_VIRTUAL_DISPLAY, SMG$CREATE_PASTEBOARD
      INTEGER SMG$PASTE_VIRTUAL_DISPLAY, SMG$PUT_CHARS
      INTEGER SMG$CHECK_FOR_OCCLUSION
      INTEGER DISPLAY1, DISPLAY2, PASTE1, PASTE2, ROWS, COLUMNS, BORDER
      INTEGER OCCLUSION, STATUS
      CHARACTER*29 TEXT

C+
C Include the SMG definitions. In particular, we want SMG$_BORDER.
C-

      INCLUDE '($SMGDEF)'

C+
C Create two virtual displays using SMG$CREATE_VIRTUAL_DISPLAY.
C Give them borders.
C-

      ROWS = 6
      COLUMNS = 50

      STATUS = SMG$CREATE_VIRTUAL_DISPLAY
1      (ROWS, COLUMNS, DISPLAY1, SMG$_BORDER)
      IF (.NOT. STATUS) CALL LIB$SIGNAL(%VAL(STATUS))

      ROWS = 5
      COLUMNS = 30

      STATUS = SMG$CREATE_VIRTUAL_DISPLAY
1      (ROWS, COLUMNS, DISPLAY2, SMG$_BORDER)
      IF (.NOT. STATUS) CALL LIB$SIGNAL(%VAL(STATUS))

C+
C Create the pasteboard using SMG$CREATE_PASTEBOARD.
C-

      STATUS = SMG$CREATE_PASTEBOARD (PASTE1)
      IF (.NOT. STATUS) CALL LIB$SIGNAL(%VAL(STATUS))

```

SMG\$ Routines

SMG\$CHECK_FOR_OCCLUSION

```
C+
C Use SMG$PUT_CHARS to put data into the virtual displays.
C-

    STATUS = SMG$PUT_CHARS ( DISPLAY1,
1      ' This virtual display has 6 rows and 50 columns.', 2, 1)
    IF (.NOT. STATUS) CALL LIB$SIGNAL(%VAL(STATUS))

    STATUS = SMG$PUT_CHARS ( DISPLAY1,
1      ' This is a bordered virtual display.', 3, 1)
    IF (.NOT. STATUS) CALL LIB$SIGNAL(%VAL(STATUS))

    STATUS = SMG$PUT_CHARS ( DISPLAY1,
1      ' SMG$PUT_CHARS puts data in this virtual display.', 4,
1      1)
    IF (.NOT. STATUS) CALL LIB$SIGNAL(%VAL(STATUS))

    STATUS = SMG$PUT_CHARS ( DISPLAY1,
1      ' This text should be partially occluded.', 5, 1)
    IF (.NOT. STATUS) CALL LIB$SIGNAL(%VAL(STATUS))

    STATUS = SMG$PUT_CHARS ( DISPLAY1,
1      ' So should part of this row.', 6, 1)
    IF (.NOT. STATUS) CALL LIB$SIGNAL(%VAL(STATUS))

    STATUS = SMG$PUT_CHARS ( DISPLAY2, ' This is virtual', 3, 1)
    IF (.NOT. STATUS) CALL LIB$SIGNAL(%VAL(STATUS))

    STATUS = SMG$PUT_CHARS ( DISPLAY2,
1      ' display #2.', 4, 1)
    IF (.NOT. STATUS) CALL LIB$SIGNAL(%VAL(STATUS))

    STATUS = SMG$PUT_CHARS ( DISPLAY2,
1      ' This is just some more text.', 5, 1)
    IF (.NOT. STATUS) CALL LIB$SIGNAL(%VAL(STATUS))

C+
C Use SMG$PASTE_VIRTUAL_DISPLAY to paste the virtual display.
C-

    STATUS = SMG$PASTE_VIRTUAL_DISPLAY ( DISPLAY1, PASTE1, 4, 15)
    IF (.NOT. STATUS) CALL LIB$SIGNAL(%VAL(STATUS))

    STATUS = SMG$PASTE_VIRTUAL_DISPLAY ( DISPLAY2, PASTE1, 8, 15)
    IF (.NOT. STATUS) CALL LIB$SIGNAL(%VAL(STATUS))

C+
C Check the two virtual displays for occlusion by calling
C SMG$CHECK_FOR_OCCLUSION.
C-

    TEXT = 'This display is not occluded.'

    STATUS = SMG$CHECK_FOR_OCCLUSION (DISPLAY1, PASTE1, OCCLUSION)
    IF (.NOT. STATUS) CALL LIB$SIGNAL(%VAL(STATUS))

    IF (OCCLUSION .EQ. 0) THEN
        STATUS = SMG$PUT_CHARS (DISPLAY1, TEXT, 1, 1)
        IF (.NOT. STATUS) CALL LIB$SIGNAL(%VAL(STATUS))
    ELSE
        STATUS = SMG$PUT_CHARS (DISPLAY1, 'Occluded.', 1, 1)
        IF (.NOT. STATUS) CALL LIB$SIGNAL(%VAL(STATUS))
    END IF

    STATUS = SMG$CHECK_FOR_OCCLUSION (DISPLAY2, PASTE1, OCCLUSION)
    IF (.NOT. STATUS) CALL LIB$SIGNAL(%VAL(STATUS))
```

SMG\$ Routines SMG\$CHECK_FOR_OCCLUSION

```
IF (OCCLUSION .EQ. 0) THEN
    STATUS = SMG$PUT_CHARS (DISPLAY2, TEXT, 1, 1)
    IF (.NOT. STATUS) CALL LIB$SIGNAL(%VAL(STATUS))
ELSE
    STATUS = SMG$PUT_CHARS (DISPLAY2, 'Occluded.', 1, 1)
    IF (.NOT. STATUS) CALL LIB$SIGNAL(%VAL(STATUS))
END IF
END
```

The output generated by this Fortran program is shown in Figure SMG-4.

Figure SMG-4 Output Generated by Fortran Program Calling SMG\$CHECK_FOR_OCCLUSION

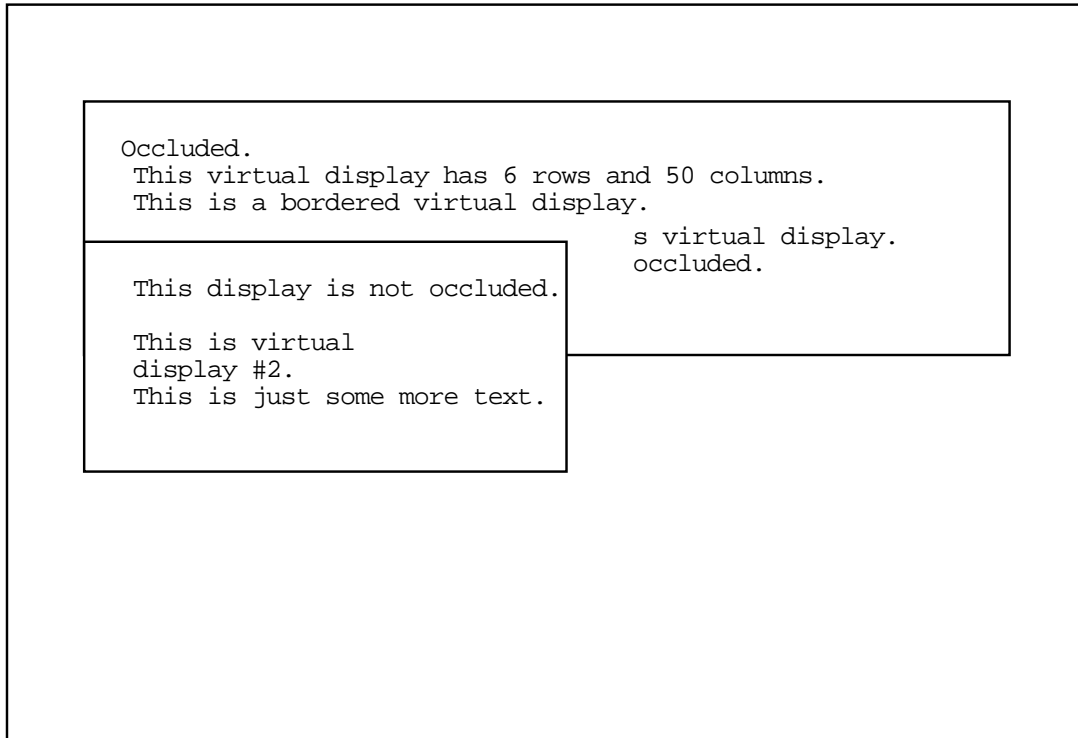

ZK-4128-GE

SMG\$CONTROL_MODE

Control Mode

The Control Mode routine controls the mode of the pasteboard. This includes buffering, minimal updating, whether the screen is cleared when the pasteboard is deleted, and whether tab characters are used for screen formatting.

Format

SMG\$CONTROL_MODE pasteboard-id [,new-mode] [,old-mode] [,buffer-size]

Returns

OpenVMS usage: cond_value
type: longword (unsigned)
access: write only
mechanism: by value

Arguments

pasteboard-id

OpenVMS usage: identifier
type: longword (unsigned)
access: read only
mechanism: by reference

Specifies the pasteboard to be changed. The **pasteboard-id** argument is the address of an unsigned longword that contains the pasteboard identifier.

The pasteboard identifier is returned by SMG\$CREATE_PASTEBOARD.

new-mode

OpenVMS usage: mask_longword
type: longword (unsigned)
access: read only
mechanism: by reference

Specifies the new control settings to be used. The optional **new-mode** argument is the address of an unsigned longword that contains the mode settings. A bit set to 1 forces that mode to be employed; a bit set to 0 inhibits that mode of operation.

Valid settings are as follows:

| | |
|---------------------|---|
| SMG\$M_BUF_ENABLED | Enables buffering. |
| SMG\$M_CLEAR_SCREEN | Causes the Screen Management Facility to clear the screen when the program exits if you have not previously deleted the pasteboard. |
| SMG\$M_IGNORE | Allows you to delete the pasteboard even if batching is in effect. |
| SMG\$M_MINUPD | Enables minimal update (the default). |
| SMG\$M_NOTABS | Causes the Screen Management Facility not to use tab characters to format the screen. |

| | |
|--------------------|---|
| SMG\$M_PROTECT | Protect pasteboard operations from AST interrupts (the default). |
| SMG\$M_RELEASE_PBD | Allows you to change the pasteboard size (using the SMG\$CHANGE_PBD_CHARACTERISTICS routine) and prevents the Screen Management Facility from modifying anything on the screen outside of the smaller pasteboard. |

All other bits must be 0 and are reserved for future use by Compaq.

old-mode

OpenVMS usage: mask_longword
type: longword (unsigned)
access: write only
mechanism: by reference

Receives the control settings that were in effect before calling this procedure. The optional **old-mode** argument is the address of an unsigned longword into which the former mode settings are written. A bit set to 1 indicates that the specified mode was employed; a bit set to 0 indicates that the mode was inhibited.

buffer-size

OpenVMS usage: word_unsigned
type: word (unsigned)
access: read only
mechanism: by reference

Specifies the size of the buffer in bytes. The optional **buffer-size** argument is the address of an unsigned word that contains the size of the buffer. The **buffer-size** argument is used when buffering mode is enabled (SMG\$M_BUF_ENABLED). The default and minimum buffer size is 256 bytes. The maximum value is 65535. The **buffer-size** value depends on user authorization file (UAF) values and is maximized with the SYSGEN parameter MAXBUF.

Description

SMG\$CONTROL_MODE lets you determine and change the mode of the Screen Management Facility operation for a specified pasteboard. By specifying different combinations of the **new-mode** and **old-mode** arguments, SMG\$CONTROL_MODE can be used in the following ways:

- To use SMG\$CONTROL_MODE to determine the current mode settings, use the following format:
SMG\$CONTROL_MODE (pasteboard_id ,,old_mode)
- To use SMG\$CONTROL_MODE to set the bits without regard to their current setting, use the following format:
SMG\$CONTROL_MODE (pasteboard_id ,new_mode)
- To use SMG\$CONTROL_MODE to save the current settings, set new modes, and later restore the original settings, use the following format:
SMG\$CONTROL_MODE (pasteboard_id ,new_mode ,old_mode)

This retrieves the current bit settings and then sets the mode according to the **new-mode** argument.

SMG\$ Routines

SMG\$CONTROL_MODE

Later, to restore the mode to its former state, specify the following format:
SMG\$CONTROL_MODE (pasteboard_id ,old_mode)

This sets the new mode according to the settings previously retrieved.

If both arguments are omitted, no information is returned.

The modes that can be determined and changed using SMG\$CONTROL_MODE are as follows:

- **Buffering**

In this mode, the Screen Management Facility buffers all output for efficient use of system QIOs. When the buffer fills, SMG\$ writes the buffer to the terminal. By calling SMG\$FLUSH_BUFFER, the user can force to the screen any output that has been placed in the pasteboard buffer but not yet written to the terminal.

- **Minimal Screen Update**

By default, the Screen Management Facility tries to minimize the number of characters actually sent to the terminal. It does this by keeping track of the current contents of the pasteboard and the new contents of the pasteboard. SMG\$ then sends only those characters that have changed.

Nonminimal updating rewrites any line containing a change, starting with the first changed character on that line.

- **Clear Screen**

By default, the Screen Management Facility does not clear the screen when the program exits if you have not already deleted the pasteboard. Use the clear screen mode to prevent this default behavior.

- **No Tabs**

If this bit is set, the Screen Management Facility does not rely on the terminal's tab settings. If it is not set, the Screen Management Facility will use physical tabs for the minimal update procedure. However, note that such use implicitly assumes that the tab stops are set to the Compaq default locations (every eight characters). Specify "no tabs" if you want to be sure that the application will run regardless of the tab settings the user has set on the terminal. By default, this bit is clear. A terminal setting of SET TERM/NOTABS may also be used to override this default.

Condition Values Returned

| | |
|-----------------|--|
| SS\$_NORMAL | Normal successful completion. |
| SMG\$_INVARG | Invalid argument. New-mode has a bit set that does not correspond to SMGSM_BUF_ENABLED, SMGSM_MINUPD, SMGSM_CLEAR_SCREEN, or SMGSM_NOTABS, or buffer size is less than 256. |
| SMG\$_INVPAS_ID | Invalid pasteboard-id . |
| SMG\$_WRONUMARG | Wrong number of arguments. |

SMG\$COPY_VIRTUAL_DISPLAY

Copy a Virtual Display

The Copy a Virtual Display routine creates a copy of an existing virtual display and assigns to it a new virtual display identifier.

Format

SMG\$COPY_VIRTUAL_DISPLAY current-display-id ,new-display-id

Returns

OpenVMS usage: cond_value
type: longword (unsigned)
access: write only
mechanism: by value

Arguments

current-display-id

OpenVMS usage: identifier
type: longword (unsigned)
access: read only
mechanism: by reference

Display identifier of the virtual display to be replicated. The **current-display-id** argument is the address of the unsigned longword that contains the display identifier.

new-display-id

OpenVMS usage: identifier
type: longword (unsigned)
access: write only
mechanism: by reference

Receives the display identifier of the newly created virtual display. The **new-display-id** argument is the address of the unsigned longword that receives the new display identifier.

Description

SMG\$COPY_VIRTUAL_DISPLAY creates a copy of an existing virtual display and assigns to it a new virtual display number. This newly created virtual display will not be pasted anywhere; use SMG\$PASTE_VIRTUAL_DISPLAY and the **new-display-id** identifier to paste the newly created virtual display. The existing display being replicated does not have to be pasted when SMG\$COPY_VIRTUAL_DISPLAY is invoked.

Condition Values Returned

| | |
|----------------|--|
| SSS_NORMAL | Normal successful completion. |
| LIB\$INSVIRMEM | Insufficient virtual memory to allocate needed buffer. |

Example

```

C+
C This Fortran example program demonstrates the use of
C SMG$COPY_VIRTUAL_DISPLAY.
C
C This routine creates a virtual display and writes it to the
C pasteboard. Data is placed in the virtual display using SMG$PUT_CHARS.
C-

        IMPLICIT INTEGER (A-Z)
        CHARACTER*29 TEXT

C+
C Include the SMG definitions. In particular, we want SMG$M_BORDER.
C-

        INCLUDE '($SMGDEF)'

C+
C Create two virtual displays using SMG$CREATE_VIRTUAL_DISPLAY.
C Give them borders.
C-

        ROWS = 6
        COLUMNS = 50

        STATUS = SMG$CREATE_VIRTUAL_DISPLAY
1         (ROWS, COLUMNS, DISPLAY1, SMG$M_BORDER)
        IF (.NOT. STATUS) CALL LIB$SIGNAL(%VAL(STATUS))

        ROWS = 5
        COLUMNS = 30

        STATUS = SMG$CREATE_VIRTUAL_DISPLAY
1         (ROWS, COLUMNS, DISPLAY2, SMG$M_BORDER)
        IF (.NOT. STATUS) CALL LIB$SIGNAL(%VAL(STATUS))

C+
C Create the pasteboard using SMG$CREATE_PASTEBOARD.
C-

        STATUS = SMG$CREATE_PASTEBOARD (PASTE1)
        IF (.NOT. STATUS) CALL LIB$SIGNAL(%VAL(STATUS))

C+
C Use SMG$PUT_CHARS to put data into the virtual displays.
C-

        STATUS = SMG$PUT_CHARS ( DISPLAY1,
1         ' This virtual display has 6 rows and 50 columns.', 2, 1)
        IF (.NOT. STATUS) CALL LIB$SIGNAL(%VAL(STATUS))

        STATUS = SMG$PUT_CHARS ( DISPLAY1,
1         ' This is a bordered virtual display.', 3, 1)
        IF (.NOT. STATUS) CALL LIB$SIGNAL(%VAL(STATUS))

        STATUS = SMG$PUT_CHARS ( DISPLAY1,
1         ' SMG$PUT_CHARS puts data in this virtual display.', 4,
1         1)
        IF (.NOT. STATUS) CALL LIB$SIGNAL(%VAL(STATUS))

        STATUS = SMG$PUT_CHARS ( DISPLAY1,
1         ' This text should be partially occluded.', 5, 1)
        IF (.NOT. STATUS) CALL LIB$SIGNAL(%VAL(STATUS))

        STATUS = SMG$PUT_CHARS ( DISPLAY1,
1         ' So should part of this row.', 6, 1)
        IF (.NOT. STATUS) CALL LIB$SIGNAL(%VAL(STATUS))

```

SMG\$ Routines

SMG\$COPY_VIRTUAL_DISPLAY

```
STATUS = SMG$PUT_CHARS ( DISPLAY2, ' This is virtual', 3, 1)
IF (.NOT. STATUS) CALL LIB$SIGNAL(%VAL(STATUS))

STATUS = SMG$PUT_CHARS ( DISPLAY2,
1 ' display #2.', 4, 1)
IF (.NOT. STATUS) CALL LIB$SIGNAL(%VAL(STATUS))

STATUS = SMG$PUT_CHARS ( DISPLAY2,
1 ' This is just some more text.', 5, 1)
IF (.NOT. STATUS) CALL LIB$SIGNAL(%VAL(STATUS))

C+
C Use SMG$PASTE_VIRTUAL_DISPLAY to paste the virtual display.
C-

STATUS = SMG$PASTE_VIRTUAL_DISPLAY ( DISPLAY1, PASTE1, 4, 15)
IF (.NOT. STATUS) CALL LIB$SIGNAL(%VAL(STATUS))

STATUS = SMG$PASTE_VIRTUAL_DISPLAY ( DISPLAY2, PASTE1, 8, 15)
IF (.NOT. STATUS) CALL LIB$SIGNAL(%VAL(STATUS))

C+
C Copy the first virtual display, the one that is partially occluded.
C-

STATUS = SMG$COPY_VIRTUAL_DISPLAY ( DISPLAY1, NEW_DISPLAY)
IF (.NOT. STATUS) CALL LIB$SIGNAL(%VAL(STATUS))

C+
C Now paste this new virtual display so that it occludes the other displays.
C-

STATUS = SMG$PASTE_VIRTUAL_DISPLAY ( NEW_DISPLAY, PASTE1, 4, 20)
IF (.NOT. STATUS) CALL LIB$SIGNAL(%VAL(STATUS))

END
```

The first virtual display created by this Fortran example is shown in Figure SMG-5.

Figure SMG-5 First Virtual Display Generated by SMG\$COPY_VIRTUAL_DISPLAY

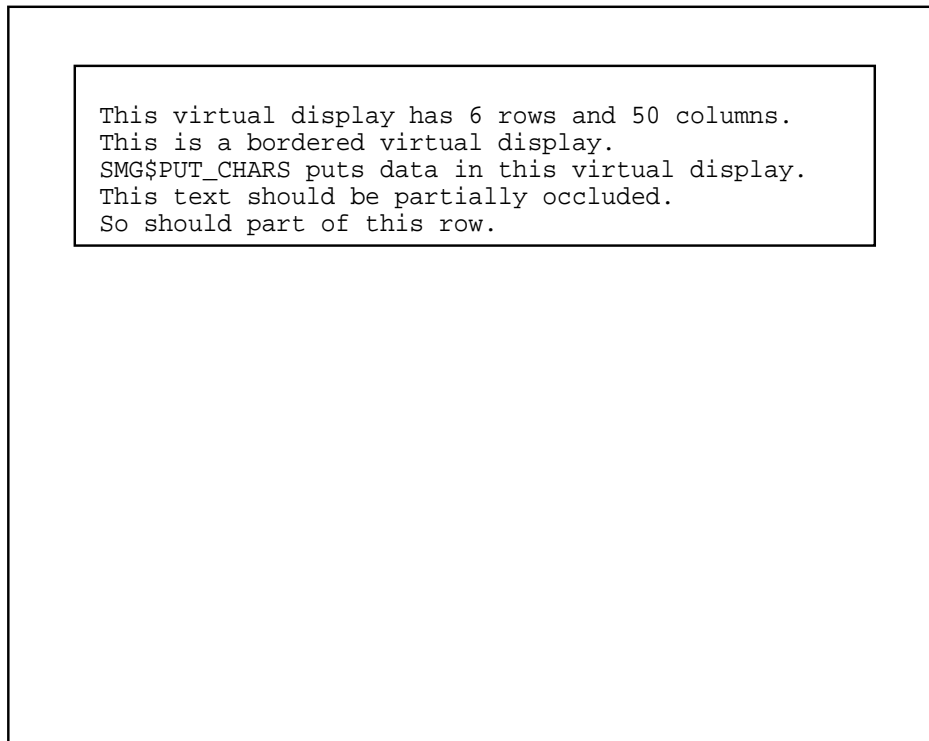

ZK-4808-GE

The second virtual display created by this Fortran example is shown in Figure SMG-6.

SMG\$ Routines
SMG\$COPY_VIRTUAL_DISPLAY

Figure SMG-6 Second Virtual Display Generated by SMG\$COPY_VIRTUAL_DISPLAY

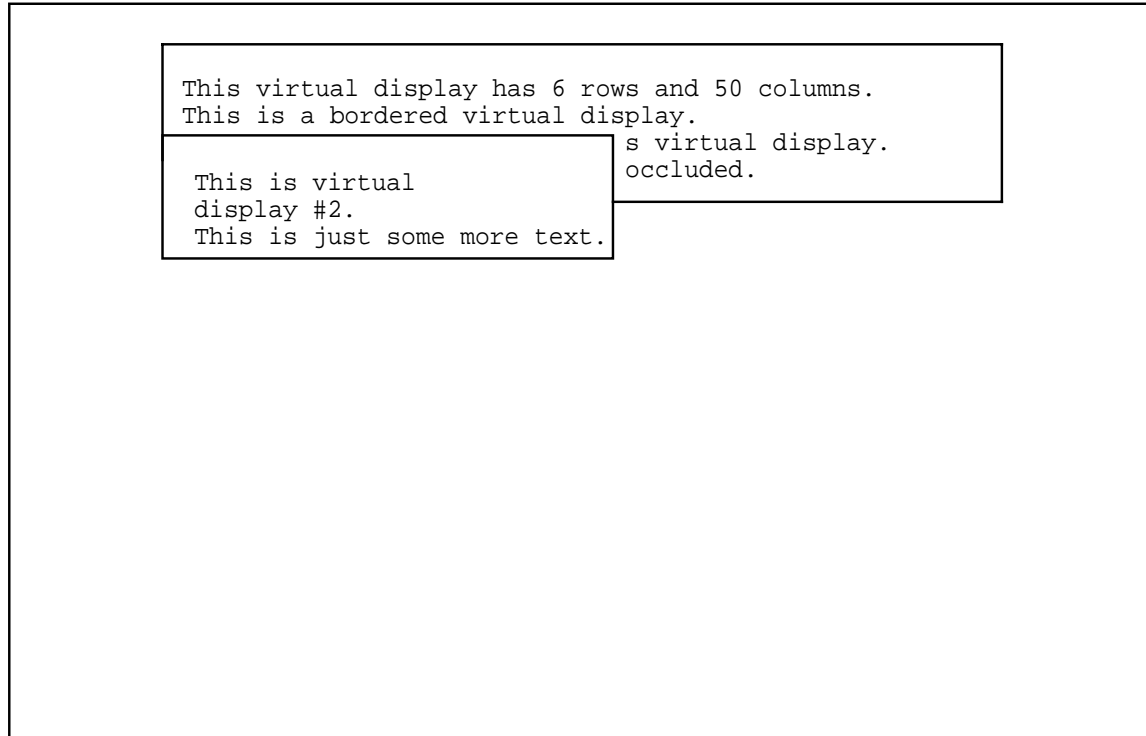

ZK-4809-GE

The output generated after the call to SMG\$COPY_VIRTUAL_DISPLAY is shown in Figure SMG-7.

Figure SMG-7 Output Generated After the Call to SMG\$COPY_VIRTUAL_DISPLAY

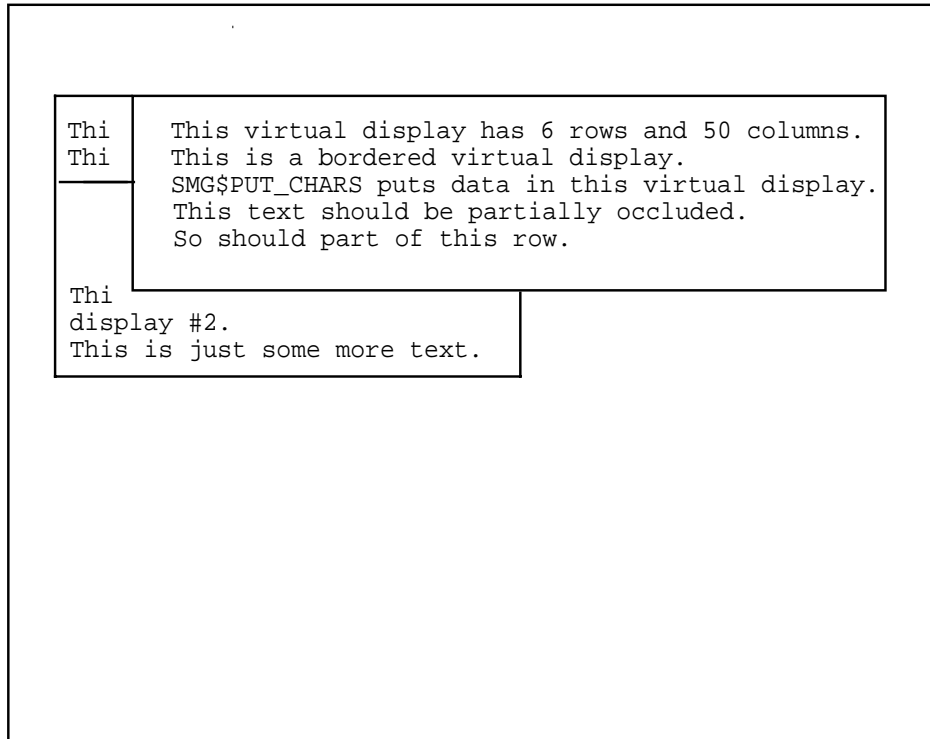

ZK-4810-GE

SMG\$ Routines

SMG\$CREATE_KEY_TABLE

SMG\$CREATE_KEY_TABLE

Create Key Table

The Create Key Table routine creates a table for key definitions.

Format

SMG\$CREATE_KEY_TABLE key-table-id

Returns

OpenVMS usage: cond_value
type: longword (unsigned)
access: write only
mechanism: by value

Argument

key-table-id
OpenVMS usage: identifier
type: longword (unsigned)
access: write only
mechanism: by reference

Receives the identifier of the newly created key table. The **key-table-id** argument is the address of an unsigned longword into which the key table identifier is written.

Description

SMG\$CREATE_KEY_TABLE creates a key definition table. You can add key definitions to this table with the SMG\$ADD_KEY_DEF, SMG\$LOAD_KEY_DEFS, and SMG\$DEFINE_KEY routines. You can list the key definitions in this table with the SMG\$LIST_KEY_DEFS routine. The key definitions in this table are used by the SMG\$READ_COMPOSED_LINE routine.

Condition Values Returned

| | |
|----------------|-------------------------------|
| SS\$NORMAL | Normal successful completion. |
| SMG\$WRONUMARG | Wrong number of arguments. |
| LIB\$INSVIRMEM | Insufficient virtual memory. |

SMG\$CREATE_MENU

Fill the Virtual Display with a Menu

The Fill the Virtual Display with a Menu routine displays menu choices in the virtual display indicated, starting at the specified row.

Format

```
SMG$CREATE_MENU  display-id ,choices [,menu-type] [,flags] [,row] [,rendition-set]
                  [,rendition-complement]
```

Returns

OpenVMS usage: cond_value
 type: longword (unsigned)
 access: write only
 mechanism: by value

Arguments

display-id

OpenVMS usage: identifier
 type: longword (unsigned)
 access: read only
 mechanism: by reference

Display identifier of the virtual display in which the menu is created. The **display-id** argument is the address of an unsigned longword containing this identifier.

choices

OpenVMS usage: static array of char_string
 type: character string
 access: read only
 mechanism: by descriptor

Static array in which each element corresponds to an item to be displayed in the menu. The **choices** argument is the address of a descriptor pointing to this static array of character strings. Note that blank menu items are ignored.

menu-type

OpenVMS usage: longword_unsigned
 type: longword (unsigned)
 access: read only
 mechanism: by reference

Optional bit mask specifying the type of menu to be displayed. The **menu-type** argument is the address of a longword bit mask that specifies this menu type. Valid values are as follows:

| | |
|-------------------|--|
| SMG\$K_BLOCK | The menu items are displayed in matrix format (default). |
| SMG\$K_VERTICAL | Each menu item is displayed on its own line. |
| SMG\$K_HORIZONTAL | The menu items are displayed all on one line. |

SMG\$ Routines

SMG\$CREATE_MENU

flags

OpenVMS usage: mask_longword
type: longword (unsigned)
access: read only
mechanism: by reference

Optional bit mask specifying the attributes to be used for the menu. The **flags** argument is the address of an unsigned longword that contains the flag. Valid values are as follows:

| | |
|---------------------|--|
| SMG\$M_DOUBLE_SPACE | Double-spaced rows of menu items. The default is single spaced. |
| SMG\$M_FIXED_FORMAT | Each menu item is in a fixed-length field. The field is the size of the largest menu item. The default is compress. |
| SMG\$M_FULL_FIELD | The full field is highlighted when you move within the menu using item keys. The default is that menu items only are highlighted. If you specify this flag value, it also implies SMG\$M_FIXED_FORMAT. |
| SMG\$M_WIDE_MENU | Wide characters are used in the menu items. The default is normal sized characters. |
| SMG\$M_WRAP_MENU | The up arrow and down arrow keys cause the menu to wrap when the cursor is on the first or last rows of the menu. |

row

OpenVMS usage: longword_signed
type: longword (signed)
access: read only
mechanism: by reference

Optional row number in the specified virtual display at which the first menu item is displayed. The **row** argument is the address of a signed longword that contains this row number. If **row** is omitted, the first row of the virtual display's scrolling region is used.

rendition-set

OpenVMS usage: mask_longword
type: longword (unsigned)
access: read only
mechanism: by reference

Attribute specifier. The optional **rendition-set** argument is the address of a longword bit mask in which each attribute set causes the corresponding attribute to be used when writing out the menu choices. The following attributes can be specified using the **rendition-set** argument:

| | |
|------------------|--|
| SMG\$M_BLINK | Displays blinking characters. |
| SMG\$M_BOLD | Displays characters in higher-than-normal intensity. |
| SMG\$M_REVERSE | Displays characters in reverse video; that is, using the opposite of the default rendition of the virtual display. |
| SMG\$M_UNDERLINE | Displays underlined characters. |

SMG\$M_USER1 Displays user-defined attributes.
through
SMG\$M_USER8

The **display-id** argument must be specified when you use the **rendition-set** argument.

rendition-complement

OpenVMS usage: mask_longword
type: longword (unsigned)
access: read only
mechanism: by reference

Attribute complement specifier. The optional **rendition-complement** argument is the address of a longword bit mask in which each attribute set causes the corresponding attribute to be complemented in the display. All of the attributes that can be specified with the **rendition-set** argument can be complemented with the **rendition-complement** argument. The **display-id** argument must be specified when you use the **rendition-complement** argument.

The optional arguments **rendition-set** and **rendition-complement** let the user control the attributes of the virtual display. The **rendition-set** argument sets certain virtual display attributes, while **rendition-complement** complements these attributes. If the same bit is specified in both the **rendition-set** and **rendition-complement** parameters, **rendition-set** is evaluated first, followed by **rendition-complement**. By using these two parameters together, the user can control each virtual display attribute in a single procedure call. On a single-attribute basis, the user can cause the following transformations:

| Set | Complement | Action |
|-----|------------|--|
| 0 | 0 | Attribute set to default |
| 1 | 0 | Attribute on |
| 0 | 1 | Attribute set to complement of default setting |
| 1 | 1 | Attribute off |

Description

SMG\$CREATE_MENU displays a list of menu choices in the virtual display's virtual scrolling region, starting in a specified row. Menu items start in the second column of the virtual display. Multiple menu items on the same row are separated by four spaces.

The choices are displayed with the specified rendition attributes in any one of the following formats:

- Vertical Each menu item is on its own line.
- Horizontal The menu items are all on one line.
- Block The menu items appear in matrix format.

Any menu items that do not fit within the bounds of the virtual display are not displayed, but are saved for later scrolling by SMG\$SELECT_FROM_MENU. The choices are single spaced by default, but if requested this can be changed to double spaced. Four spaces separate each menu item horizontally. If requested, the items can also be displayed in fixed format columns where the width of the column is equal to the size of the largest string passed.

SMG\$ Routines

SMG\$CREATE_MENU

After a call to SMG\$CREATE_MENU, the user must not output any characters to the display that disturb the rows containing the newly created menu. If characters are output that do interfere with the menu, unpredictable results will be generated. Use the SMG\$SELECT_FROM_MENU routine to select an item from this menu.

SMG\$CREATE_MENU supports one-dimensional Noncontiguous Array (NCA) and Varying String Array (VSA) string arrays. NCA and VSA string arrays include all string arrays generated by Compaq Ada, Compaq BASIC, VAX DIBOL, Compaq Fortran, Compaq Pascal, and VAX PL/I. (Note that if you are calling SMG\$CREATE_MENU from VAX BASIC, you must still use a MAP statement to declare the array.)

Condition Values Returned

| | |
|-----------------|---|
| SS\$_NORMAL | Normal successful completion. |
| SMG\$_INVDIS_ID | The display identifier is invalid or contains a viewport. |
| SMG\$_xxxx | Any condition value returned by SMG\$PUT_CHARS, SMG\$BEGIN_DISPLAY_UPDATE, and SMG\$END_DISPLAY_UPDATE. |
| LIB\$_xxxx | Any condition value returned by LIB\$CREATE_VM_ZONE, LIB\$GET_VM, LIB\$FREE_VM. |

SMG\$CREATE_PASTEBOARD

Create a Pasteboard

The Create a Pasteboard routine creates a pasteboard and returns its assigned pasteboard identifier.

Format

```
SMG$CREATE_PASTEBOARD  pasteboard-id [,output-device]
                        [,number-of-pasteboard-rows]
                        [,number-of-pasteboard-columns] [,flags]
                        [,type-of-terminal] [,device-name]
```

Returns

OpenVMS usage: cond_value
 type: longword (unsigned)
 access: write only
 mechanism: by value

Arguments

pasteboard-id

OpenVMS usage: identifier
 type: longword (unsigned)
 access: write only
 mechanism: by reference

Receives the identifier of the newly created pasteboard. The **pasteboard-id** argument is the address of an unsigned longword into which the new pasteboard identifier is written.

output-device

OpenVMS usage: device_name
 type: character string
 access: read only
 mechanism: by descriptor

Specifies the file specification or logical name to which the output associated with this pasteboard will be written. The **output-device** argument is the address of a descriptor that points to the name of the output device. If omitted, output is sent to SYSS\$OUTPUT.

number-of-pasteboard-rows

OpenVMS usage: longword_signed
 type: longword (signed)
 access: write only
 mechanism: by reference

Receives the number of rows on the device specified in the **output-device** argument. The **number-of-pasteboard-rows** argument is the address of a signed longword into which is written the number of rows on the specified device, which will be the number of rows in the pasteboard.

SMG\$ Routines

SMG\$CREATE_PASTEBOARD

number-of-pasteboard-columns

OpenVMS usage: longword_signed
type: longword (signed)
access: write only
mechanism: by reference

Receives the number of columns on the device specified in the **output-device** argument. The **number-of-pasteboard-columns** argument is the address of a signed longword into which the number of columns on the specified device is written.

flags

OpenVMS usage: mask_longword
type: longword (unsigned)
access: read only
mechanism: by reference

Specifies the attributes to be used in the pasteboard. The **flags** argument is the address of an unsigned longword that contains the flag. The default action is to clear the screen when the pasteboard is created.

Valid values are as follows:

| | |
|----------------------|--|
| SMG\$M_KEEP_CONTENTS | The screen is not initially cleared. The Screen Management Facility works best when it can manage the entire screen. Therefore, using SMG\$M_KEEP_CONTENTS is discouraged. |
| SMG\$M_WORKSTATION | Calls DECterm to create a DECterm window if the Screen Management Facility is running on a workstation that is running DECwindows. If it is not running on a workstation that is running DECwindows, this flag is ignored. |

type-of-terminal

OpenVMS usage: mask_longword
type: longword (unsigned)
access: write only
mechanism: by reference

Receives the SMG\$ internal device type to which the output associated with this pasteboard will be written. The **type-of-terminal** argument is the address of an unsigned longword into which is written the terminal type.

The returned values are as follows:

SMG\$K_UNKNOWN
SMG\$K_VTFOREIGN
SMG\$K_HARDCOPY
SMG\$K_VTTERMTABLE

If a value other than SMG\$K_VTTERMTABLE is returned, you must use SMG\$SNAPSHOT to output the contents of the pasteboard.

device-name

OpenVMS usage: char_string
type: character string
access: write only
mechanism: by descriptor

Receives the device name of the device on which the output associated with this pasteboard is written. The **device-name** argument is the address of a descriptor into which is written the device name.

If you specify the SMG\$M_WORKSTATION value to the **flags** argument, this argument returns the DECwindows terminal device name created by the Screen Management Facility for this pasteboard. (You can then specify the device name in a call to SMG\$CREATE_VIRTUAL_KEYBOARD to allow reading of input from the DECTerm window.) Otherwise, the string specified by OUT_DEVICE is returned.

Description

SMG\$CREATE_PASTEBOARD creates a new pasteboard, associates it with the device specified by **output-device**, and returns its assigned **pasteboard-id**. Note that if you request a pasteboard on a device that already has a pasteboard assigned, this routine returns the **pasteboard-id** of the existing pasteboard and returns the SMG\$_PASALREXI status code.

If a program calls both SMG\$CREATE_PASTEBOARD and SMG\$CREATE_VIRTUAL_KEYBOARD, make sure SMG\$CREATE_PASTEBOARD is called first. The program will not function correctly if SMG\$CREATE_VIRTUAL_KEYBOARD is called before SMG\$CREATE_PASTEBOARD.

Condition Values Returned

| | |
|-----------------|---|
| SS\$_NORMAL | Normal successful completion. |
| SMG\$_PASALREXI | Successful completion. A pasteboard already exists for this device. |
| SMG\$_WRONUMARG | Wrong number of arguments. |
| LIB\$_INSVIRMEM | Insufficient virtual memory to allocate needed buffer. |

Any condition values returned by LIB\$GET_EF, LIB\$GET_VM, \$QIO, \$GETDVI, \$ASSIGN.

SMG\$ Routines

SMG\$CREATE_PASTEBOARD

Example

```
C+                               SMG1.FOR
C This Fortran example program demonstrates the use of
C SMG$CREATE_PASTEBOARD.
C-
      IMPLICIT INTEGER*4 (A-Z)
      SMG$M_BOLD = 1
      SMG$M_REVERSE = 2
      SMG$M_BLINK = 4
      SMG$M_UNDERLINE = 8
C+
C Establish the terminal screen as a pasteboard
C by calling SMG$CREATE_PASTEBOARD.
C-
      STATUS = SMG$CREATE_PASTEBOARD (NEW_PID,,,)
      IF (.NOT. STATUS) CALL LIB$STOP(%VAL(STATUS))
C+
C Establish a virtual display region by calling
C SMG$CREATE_VIRTUAL_DISPLAY.
C-
      STATUS = SMG$CREATE_VIRTUAL_DISPLAY (5,80,DISPLAY_ID,,,)
      IF (.NOT. STATUS) CALL LIB$STOP(%VAL(STATUS))
C+
C Paste the virtual display to the screen, starting at
C row 10, column 15 using SMG$PASTE_VIRTUAL_DISPLAY.
C-
      STATUS = SMG$PASTE_VIRTUAL_DISPLAY(DISPLAY_ID,NEW_PID,10,15)
      IF (.NOT. STATUS) CALL LIB$STOP(%VAL(STATUS))
C+
C Write three lines to the screen using SMG$PUT_LINE.
C-
      STATUS = SMG$PUT_LINE (DISPLAY_ID,'This line is underlined',2,
1                               SMG$M_UNDERLINE,0,,)
      IF (.NOT. STATUS) CALL LIB$STOP(%VAL(STATUS))
      STATUS = SMG$PUT_LINE (DISPLAY_ID,'This line is blinking',2,
1                               SMG$M_BLINK,0,,)
      IF (.NOT. STATUS) CALL LIB$STOP(%VAL(STATUS))
      STATUS = SMG$PUT_LINE (DISPLAY_ID,'This line is reverse video',2,
1                               SMG$M_REVERSE,0,,)
      IF (.NOT. STATUS) CALL LIB$STOP(%VAL(STATUS))
      END
```

This Fortran program calls SMG\$ routines to format screen output.

SMG\$CREATE_SUBPROCESS

Create and Initialize a Subprocess

The Create and Initialize a Subprocess routine creates a DCL subprocess and associates it with a virtual display.

Format

SMG\$CREATE_SUBPROCESS display-id [,AST-routine] [,AST-argument] [,flags]

Returns

OpenVMS usage: cond_value
type: longword (unsigned)
access: write only
mechanism: by value

Arguments

display-id

OpenVMS usage: identifier
type: longword (unsigned)
access: read only
mechanism: by reference

Identifier of the virtual display with which the newly created subprocess is associated. The **display-id** argument is the address of an unsigned longword containing this identifier.

AST-routine

OpenVMS usage: ast_procedure
type: procedure value
access: call without stack unwinding
mechanism: by value

Optional AST routine to be called when the currently executing command completes. The **AST-routine** argument is the routine's procedure value.

The AST routine is called with five parameters. The first parameter is a pointer to a data structure that contains the **display-id**, **AST-argument**, and the command-status values. The remaining four parameters for the AST routine are R0, R1, PC, and PSL. The following figure illustrates the **AST-routine** parameters and the data structure pointed to by the first parameter.

SMG\$ Routines

SMG\$CREATE_SUBPROCESS

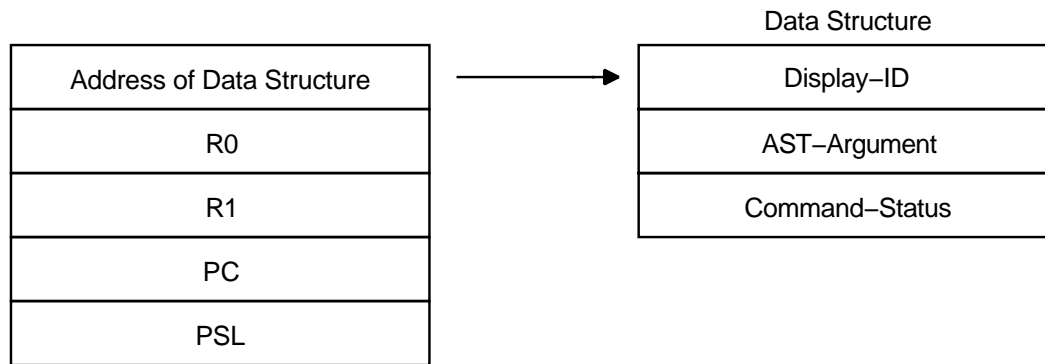

ZK-6508-GE

If the **AST-routine** argument is specified, the routine SMG\$EXECUTE_COMMAND buffers any commands passed to it and executes them in order, calling the specified AST routine when each command completes. If the **AST-routine** argument is not specified, SMG\$EXECUTE_COMMAND waits until the specified command completes before returning control to the user.

AST-argument

OpenVMS usage: user_arg
 type: longword (unsigned)
 access: read only
 mechanism: by value

Optional argument you supply to the AST routine. The **AST-argument** parameter is an unsigned longword that contains the value to be passed to the AST routine.

flags

OpenVMS usage: mask_longword
 type: longword (unsigned)
 access: read only
 mechanism: by reference

Optional argument you supply to SMG\$CREATE_SUBPROCESS. SMG\$CREATE_SUBPROCESS calls LIB\$SPAWN to create the subprocess. The **flags** argument lets you control some of the flags used in that call. Flags available to SMG\$CREATE_SUBPROCESS correspond to flags in LIB\$SPAWN as follows:

SMG\$ Routines

SMG\$CREATE_SUBPROCESS

| SMG\$CREATE_SUBPROCESS Flag | LIB\$SPAWN Flag | Function |
|--------------------------------|--------------------|--|
| SMG\$M_TRUSTED | TRUSTED | If this bit is set, it indicates a SPAWN command on behalf of the application. If this bit is not set, it indicates that the SPAWN command originates from the user. SPAWN commands originating from users are disallowed in captive accounts (DCL). |
| SMG\$M_AUTHPRIV | AUTHPRIV | If this bit is set, the subprocess inherits the caller's authorized privileges. If this bit is clear, the spawned processes' authorized mask is set equal to the caller's current (active) privilege mask. |
| SMG\$M_SUBSYSTEM | SUBSYSTEM | If this bit is set, a spawned process inherits protected subsystem IDs for the duration of LOGINOUT.EXE (used to map the command line interpreter). The IDs will be removed in the process of transferring control to the command language interpreter (CLI) (as a user mode \$RUNDOWN is performed). If this bit is clear, LOGINOUT does not execute under the subsystem IDs. |

The default is that none of these bits is set. See online Help or the *OpenVMS RTL Library (LIB\$) Manual* for a complete description of LIB\$SPAWN, these flags, and the security consideration surrounding their use.

Description

SMG\$CREATE_SUBPROCESS lets you create a DCL subprocess and associate this subprocess with a virtual display. (The subprocess is initialized using the DCL commands SET NOVERIFY and SET NOON.) From your main process you can then specify commands to be executed by the subprocess using the SMG\$EXECUTE_COMMAND routine. Communication between processes is performed using mailboxes, thus allowing you to control the input commands and the output text. When buffering commands, use the optional AST routine to notify your main process whenever a command is completed. Broadcast trapping and unsolicited input do not have to be disabled to use this routine. For more information on mailboxes, see the mailbox driver section of the *OpenVMS I/O User's Reference Manual*.

SMG\$ Routines

SMG\$CREATE_SUBPROCESS

Before creating the subprocess, the Screen Management Facility checks to ensure that you have sufficient resources to create the necessary mailboxes and the subprocess. A remaining BYTLM value of at least 5000 and a remaining PRCLM value of at least 1 are required.

The Screen Management Facility declares an exit handler that deletes the subprocess if the user exits without first calling the routine SMG\$DELETE_SUBPROCESS. Under some circumstances, however, these facility-supplied exit handlers are not executed. In this case, you must delete the subprocess with the DCL command SHOW PROCESS/SUB followed by the DCL command STOP.

Condition Values Returned

| | |
|-----------------|--|
| SS\$_NORMAL | Normal successful completion. |
| SMG\$_INSQUOCRE | Insufficient quota remaining to create subprocess. |
| SMG\$_INVDIS_ID | Invalid display-id . |
| SMG\$_SUBALREXI | Subprocess already exists for this display-id (alternate success status). |
| SS\$_xxxx | Any status from \$GETDVI, \$GETJPI, \$DCLEXH, or \$CREMBX. |
| LIB\$_xxxx | Any status from LIB\$SPAWN, LIB\$GET_EF, LIB\$GET_VM. |

Example

```
10
!
! This VAX BASIC program demonstrates the use of
! SMG$CREATE_SUBPROCESS.
!

OPTION TYPE = EXPLICIT
OPTION CONSTANT TYPE = INTEGER

%INCLUDE "LIB$ROUTINES" %FROM %LIBRARY "SYS$LIBRARY:BASIC$STARLET"
%INCLUDE "SMG$ROUTINES" %FROM %LIBRARY "SYS$LIBRARY:BASIC$STARLET"   !*** new line
%INCLUDE "$SMGDEF" %FROM %LIBRARY "SYS$LIBRARY:BASIC$STARLET"
%INCLUDE "$SSDEF" %FROM %LIBRARY "SYS$LIBRARY:BASIC$STARLET"

COMMON LONG NUM_COMMANDS

DECLARE SMG$_SUBPROCESS_INFO_TABLE SMG_INFO      !***
DECLARE LONG S, PASTEBOARD_ID, DISPLAY_ID, STATUS_DISPLAY_ID

EXTERNAL INTEGER COMPLETION_ROUTINE             !***

S = SMG$CREATE_PASTEBOARD (PASTEBOARD_ID)
IF S <> SS$_NORMAL THEN CALL LIB$SIGNAL (S) END IF

S = SMG$CREATE_VIRTUAL_DISPLAY (12,75,DISPLAY_ID,SMG$_M_BORDER)
IF S <> SS$_NORMAL THEN CALL LIB$SIGNAL (S) END IF

S = SMG$CREATE_VIRTUAL_DISPLAY (5,75,STATUS_DISPLAY_ID,SMG$_M_BORDER)
IF S <> SS$_NORMAL THEN CALL LIB$SIGNAL (S) END IF

S = SMG$PASTE_VIRTUAL_DISPLAY (DISPLAY_ID,PASTEBOARD_ID,2,2)
IF S <> SS$_NORMAL THEN CALL LIB$SIGNAL (S) END IF

S = SMG$PASTE_VIRTUAL_DISPLAY (STATUS_DISPLAY_ID,PASTEBOARD_ID,17,2)
IF S <> SS$_NORMAL THEN CALL LIB$SIGNAL (S) END IF
```

SMG\$ Routines SMG\$CREATE_SUBPROCESS

```
S = SMG$CREATE_SUBPROCESS (DISPLAY_ID,      &
    LOC(COMPLETION_ROUTINE), &
    STATUS_DISPLAY_ID)
IF S <> SS$NORMAL THEN CALL LIB$SIGNAL (S) END IF

NUM_COMMANDS = 1
S= SMG$EXECUTE_COMMAND(DISPLAY_ID, "$SHOW DEFAULT")
IF S <> SS$NORMAL THEN CALL LIB$SIGNAL (S) END IF

NUM_COMMANDS = NUM_COMMANDS + 1
S= SMG$EXECUTE_COMMAND(DISPLAY_ID, "$SHOW TIME")
IF S <> SS$NORMAL THEN CALL LIB$SIGNAL (S) END IF

NUM_COMMANDS = NUM_COMMANDS + 1
S= SMG$EXECUTE_COMMAND(DISPLAY_ID, "$SHOW QUOTA")
IF S <> SS$NORMAL THEN CALL LIB$SIGNAL (S) END IF
SLEEP (5) UNTIL NUM_COMMANDS <= 0
END

20 SUB COMPLETION_ROUTINE(SMG$R_SUBPROCESS_INFO_TABLE SMG_INFO, & !***
    LONG R0, LONG R1, LONG PC, LONG PSL)
OPTION TYPE = EXPLICIT
OPTION CONSTANT TYPE = INTEGER
%INCLUDE "$SMGDEF" %FROM %LIBRARY "SYS$LIBRARY:BASIC$STARLET"
%INCLUDE "$SSDEF" %FROM %LIBRARY "SYS$LIBRARY:BASIC$STARLET"

COMMON LONG NUM_COMMANDS

DECLARE LONG S

EXTERNAL LONG FUNCTION LIB$SIGNAL(LONG), &
    SMG$PUT_LINE (LONG, STRING)

NUM_COMMANDS = NUM_COMMANDS - 1

IF (SMG_INFO::SMG$L_STATUS AND 1) <> 0
THEN
    S = SMG$PUT_LINE(SMG_INFO::SMG$L_USR_ARG, "command completed")
    IF S <> SS$NORMAL THEN CALL LIB$SIGNAL (S) END IF
ELSE
    S = SMG$PUT_LINE(SMG_INFO::SMG$L_USR_ARG, "command failed")
    IF S <> SS$NORMAL THEN CALL LIB$SIGNAL (S) END IF
END IF

SUBEND
```

SMG\$CREATE_VIEWPORT

Create a Virtual Viewport

The Create a Virtual Viewport routine creates a viewport and associates it with a virtual display. The location and size of the viewport are specified by the caller.

Format

```
SMG$CREATE_VIEWPORT display-id ,viewport-row-start ,viewport-column-start  
                    ,viewport-number-rows ,viewport-number-columns
```

Returns

OpenVMS usage: cond_value
type: longword (unsigned)
access: write only
mechanism: by value

Arguments

display-id

OpenVMS usage: identifier
type: longword (unsigned)
access: read only
mechanism: by reference

Display identifier of the virtual display associated with the newly created viewport. The **display-id** argument is the address of an unsigned longword containing this identifier.

viewport-row-start

OpenVMS usage: longword_signed
type: longword (signed)
access: read only
mechanism: by reference

Row number in the virtual display that will become row 1 in the viewport. The **viewport-row-start** argument is the address of a signed longword containing the row number.

viewport-column-start

OpenVMS usage: longword_signed
type: longword (signed)
access: read only
mechanism: by reference

Column number in the virtual display that will become column 1 in the viewport. The **viewport-column-start** argument is the address of a signed longword containing the column number.

viewport-number-rows

OpenVMS usage: longword_signed
type: longword (signed)
access: read only
mechanism: by reference

Number of rows in the viewport. The **viewport-number-rows** argument is the address of a signed longword containing the number of rows in the newly created viewport.

viewport-number-columns

OpenVMS usage: longword_signed
 type: longword (signed)
 access: read only
 mechanism: by reference

Number of columns in the viewport. The **viewport-number-columns** argument is the address of a signed longword containing the number of columns in the newly created viewport.

Description

SMG\$CREATE_VIEWPORT creates a viewport and associates it with a particular virtual display. The virtual display must be created before the viewport can be created, and you can only create one viewport for each virtual display. In order to make the viewport visible, you have to paste the virtual display by calling the SMG\$PASTE_VIRTUAL_DISPLAY routine; only the portion of the virtual display that falls inside the viewport is visible. You can delete a viewport with the SMG\$DELETE_VIEWPORT routine.

Condition Values Returned

| | |
|------------------|--|
| SS\$ _NORMAL | Normal successful completion. |
| SMG\$ _INVARG | Number of rows or columns is less than zero. |
| SMG\$ _INVCOL | Invalid column specified. |
| SMG\$ _INVDIS_ID | Invalid display-id . |
| SMG\$ _INVROW | Invalid row specified. |
| SMG\$ _WINEXISTS | Viewport already exists on the virtual display (alternate success status). |
| SMG\$ _WRONUMARG | Wrong number of arguments. |

Example

```
C+
C This Fortran example creates two virtual displays, one
C being a copy of the other. The initial virtual display is
C filled and pasted to the pasteboard. The second virtual
C display is assigned a viewport and then pasted to the
C pasteboard. Therefore, only the section of the second
C virtual display that falls inside the viewport is visible.
C-
  IMPLICIT INTEGER (A-Z)
  INCLUDE '($SMGDEF)'

C Create the Virtual Display. Give it a border.

  ROWS = 9
  COLUMNS = 32

  STATUS = SMG$CREATE_VIRTUAL_DISPLAY
           1 (ROWS, COLUMNS, DISPLAY1, SMG$M_BORDER )
  IF (.NOT. STATUS) call lib$signal(%val(STATUS))

C Create the Pasteboard
```

SMG\$ Routines

SMG\$CREATE_VIEWPORT

```
STATUS = SMG$CREATE_PASTEBOARD (PASTE1)
IF (.NOT. STATUS) call lib$signal(%val(STATUS))

C Put data in the Virtual Display

STATUS = SMG$PUT_CHARS ( DISPLAY1,
  1 'This is row number 1, you see.', 1, 1)
IF (.not. STATUS) call lib$signal(%val(STATUS))

STATUS = SMG$PUT_CHARS ( DISPLAY1,
  1 'This is row number 2, you see.', 2, 1)
IF (.not. STATUS) call lib$signal(%val(STATUS))

STATUS = SMG$PUT_CHARS ( DISPLAY1,
  1 'This is row number 3, you see.', 3, 1)
IF (.not. STATUS) call lib$signal(%val(STATUS))

STATUS = SMG$PUT_CHARS ( DISPLAY1,
  1 'This is row number 4, you see.', 4,1)
IF (.not. STATUS) call lib$signal(%val(STATUS))

STATUS = SMG$PUT_CHARS ( DISPLAY1,
  1 'This is row number 5, you see.', 5, 1)
IF (.not. STATUS) call lib$signal(%val(STATUS))

STATUS = SMG$PUT_CHARS ( DISPLAY1,
  1 'This is row number 6, you see.', 6, 1)
IF (.not. STATUS) call lib$signal(%val(STATUS))

STATUS = SMG$PUT_CHARS ( DISPLAY1,
  1 'This is row number 7, you see.', 7, 1)
IF (.not. STATUS) call lib$signal(%val(STATUS))

STATUS = SMG$PUT_CHARS ( DISPLAY1,
  1 'This is row number 8, you see.', 8, 1)
IF (.not. STATUS) call lib$signal(%val(STATUS))

STATUS = SMG$PUT_CHARS ( DISPLAY1,
  1 'This is row number 9, you see.', 9, 1)
IF (.not. STATUS) call lib$signal(%val(STATUS))

C Paste the Virtual Display
STATUS = SMG$PASTE_VIRTUAL_DISPLAY (DISPLAY1, PASTE1, 2, 2)
IF (.NOT. STATUS) call lib$signal(%VAL(STATUS))

STATUS = SMG$LABEL_BORDER (DISPLAY1, 'Full Display',,,SMG$M_BOLD)
IF (.NOT. STATUS) CALL LIB$SIGNAL(%VAL(STATUS))

STATUS = SMG$COPY_VIRTUAL_DISPLAY (DISPLAY1, DISPLAY2)
IF (.NOT. STATUS) CALL LIB$SIGNAL(%VAL(STATUS))

STATUS = SMG$LABEL_BORDER (DISPLAY2, 'Viewport',,,SMG$M_BOLD)
IF (.NOT. STATUS) CALL LIB$SIGNAL(%VAL(STATUS))

STATUS = SMG$CREATE_VIEWPORT ( DISPLAY2, 3, 9, 3, 12)
IF (.NOT. STATUS) call lib$signal(%VAL(STATUS))

STATUS = SMG$PASTE_VIRTUAL_DISPLAY ( DISPLAY2, PASTE1, 15, 20)
IF (.NOT. STATUS) call lib$signal(%VAL(STATUS))

END
```

In this Compaq Fortran example, the initial virtual display is copied to a second virtual display that has a viewport associated with it. When the second virtual display is pasted, only the portion of the virtual display that falls inside the viewport is visible. This is shown in Figure SMG-8.

Figure SMG-8 Output Generated by Creating a Viewport

```
      Full Display
This is row number 1, you see.
This is row number 2, you see.
This is row number 3, you see.
This is row number 4, you see.
This is row number 5, you see.
This is row number 6, you see.
This is row number 7, you see.
This is row number 8, you see.
This is row number 9, you see.

      Viewport
row number 3
row number 4
row number 5
```

ZK-6424-GE

SMG\$CREATE_VIRTUAL_DISPLAY

Create a Virtual Display

The Create Virtual Display routine creates a virtual display and returns its assigned display identifier.

Format

```
SMG$CREATE_VIRTUAL_DISPLAY  number-of-rows ,number-of-columns ,display-id  
                             [,display-attributes] [,video-attributes]  
                             [,character-set]
```

Returns

OpenVMS usage: cond_value
type: longword (unsigned)
access: write only
mechanism: by value

Arguments

number-of-rows

OpenVMS usage: longword_signed
type: longword (signed)
access: read only
mechanism: by reference

Specifies the number of rows in the newly created virtual display. The **number-of-rows** argument is the address of a signed longword that contains the desired number of rows.

number-of-columns

OpenVMS usage: longword_signed
type: longword (signed)
access: read only
mechanism: by reference

Specifies the number of columns in the newly created virtual display. The **number-of-columns** argument is the address of a signed longword that contains the desired number of columns.

display-id

OpenVMS usage: identifier
type: longword (unsigned)
access: write only
mechanism: by reference

Receives the **display-id** of the newly created virtual display. The **display-id** argument is the address of an unsigned longword into which is written the display identifier.

display-attributes

OpenVMS usage: mask_longword
type: longword (unsigned)
access: read only
mechanism: by reference

SMG\$ Routines SMG\$CREATE_VIRTUAL_DISPLAY

Receives the current default display attributes. The optional **display-attributes** argument is the address of an unsigned longword into which the current display attributes are written.

Valid values for **display-attributes** are as follows:

| | |
|-------------------------|---|
| SMG\$M_BORDER | Specifies a bordered display. If omitted, the display is not bordered. |
| SMG\$M_BLOCK_BORDER | Specifies a block-bordered display. If omitted, the display is not bordered. |
| SMG\$M_DISPLAY_CONTROLS | Specifies that control characters such as carriage return and line feed are displayed as graphic characters, if your terminal supports them. |
| SMG\$M_PROTECT_DISPLAY | Instructs the Screen Management Facility to return an error (SMG\$DSPIN_USE) if an SMG\$ call is made from an AST routine that interrupted an SMG\$ call on the same display. |
| SMG\$M_TRUNC_ICON | Specifies that an icon (generally a diamond shape) is displayed where truncation of a line exceeding the width of the virtual display has occurred. |

video-attributes

OpenVMS usage: mask_longword
type: longword (unsigned)
access: read only
mechanism: by reference

Specifies the default rendition to be applied to all output in this virtual display unless overridden by a call to a specific output routine (for example, SMG\$CHANGE_RENDITION). The **video-attributes** argument is the address of an unsigned longword that contains the video attributes mask.

Valid values for this argument are as follows:

| | |
|--------------------------------------|---|
| SMG\$M_BLINK | Displays blinking characters. |
| SMG\$M_BOLD | Displays characters in higher-than-normal intensity. |
| SMG\$M_REVERSE | Displays characters in reverse video, that is, using the opposite of the default rendition of the virtual display. |
| SMG\$M_UNDERLINE | Displays underlined characters. |
| SMG\$M_INVISIBLE | Specifies invisible characters; that is, the characters exist in the virtual display but do not appear on the pasteboard. |
| SMG\$M_USER1 through SMG\$M_USER8 | Displays user-defined attributes. |

SMG\$ Routines

SMG\$CREATE_VIRTUAL_DISPLAY

character-set

OpenVMS usage: longword_unsigned
type: longword (unsigned)
access: read only
mechanism: by reference

Specifies the default character set for all text in this virtual display. The **character-set** argument is the address of an unsigned longword that contains the character set specifier. Valid values are SMG\$C_ASCII (the default), and SMG\$C_SPEC_GRAPHICS.

Description

SMG\$CREATE_VIRTUAL_DISPLAY creates a new virtual display and returns its display identifier. Initially, the virtual display contains blanks, and the virtual cursor is positioned at row 1, column 1. The virtual scrolling region is the entire virtual display. To make the display visible, use the SMG\$PASTE_VIRTUAL_DISPLAY routine.

Condition Values Returned

| | |
|------------------|--|
| SS\$ _NORMAL | Normal successful completion. |
| LIB\$ _INSVIRMEM | Insufficient virtual memory. |
| SMG\$ _DSPIN_USE | An SMG\$ call was made from an AST routine that interrupted an SMG\$ call on the same display. |
| SMG\$ _INVARG | Invalid argument. The video-attributes or display-attributes argument contains an unknown value. |
| SMG\$ _WRONUMARG | Wrong number of arguments. |

Example

```
C+
C This Fortran example program demonstrates the use of
C SMG$ERASE_PASTEBOARD.
C-

      IMPLICIT INTEGER*4 (A-Z)
      CHARACTER*80   OUT_STR,TRIM_STR
      CHARACTER*18   PROMPT          //'Please enter data '/

      SMG$M_BOLD = 1
      SMG$M_REVERSE = 2
      SMG$M_BLINK = 4
      SMG$M_UNDERLINE = 8

C+
C Establish the terminal screen as a pasteboard using
C SMG$CREATE_PASTEBOARD.
C-

      STATUS = SMG$CREATE_PASTEBOARD (NEW_PID,,,)
      IF (.NOT. STATUS) CALL LIB$STOP(%VAL(STATUS))

C+
C Establish the terminal keyboard as the virtual keyboard
C by calling SMG$CREATE_VIRTUAL_KEYBOARD.
C-
```

SMG\$ Routines

SMG\$CREATE_VIRTUAL_DISPLAY

```

        STATUS = SMG$CREATE_VIRTUAL_KEYBOARD(KEYBOARD_ID,,,)
        IF (.NOT. STATUS) CALL LIB$STOP(%VAL(STATUS))
C+
C Establish a virtual display region by
C calling SMG$CREATE_VIRTUAL_DISPLAY.
C-
        STATUS = SMG$CREATE_VIRTUAL_DISPLAY (5,80,DISPLAY_ID,,)
        IF (.NOT. STATUS) CALL LIB$STOP(%VAL(STATUS))
C+
C Paste the virtual display to the screen, starting at
C row 10, column 15. To paste the virtual display, use
C SMG$PASTE_VIRTUAL_DISPLAY.
C-
        STATUS = SMG$PASTE_VIRTUAL_DISPLAY(DISPLAY_ID,NEW_PID,10,15)
        IF (.NOT. STATUS) CALL LIB$STOP(%VAL(STATUS))
C+
C Prompt the user for input, and accept that input using
C SMG$READ_STRING.
C-
        STATUS = SMG$READ_STRING(KEYBOARD_ID,OUT_STR,PROMPT,,,,,,,,)
        IF (.NOT. STATUS) CALL LIB$STOP(%VAL(STATUS))
C+
C Clear the screen using SMG$ERASE_PASTEBOARD.
C-
        STATUS = SMG$ERASE_PASTEBOARD (NEW_PID)
        IF (.NOT. STATUS) CALL LIB$STOP(%VAL(STATUS))
C+
C Trim any trailing blanks from the user input
C by calling STR$TRIM.
C-
        STATUS = STR$TRIM(TRIM_STR,OUT_STR,STR_LEN)
        IF (.NOT. STATUS) CALL LIB$STOP(%VAL(STATUS))
C+
C Display the data input by the user using SMG$PUT_CHARS
C and SMG$PUT_LINE.
C-
        STATUS = SMG$PUT_CHARS(DISPLAY_ID,'You entered: ',,,,,,)
        IF (.NOT. STATUS) CALL LIB$STOP(%VAL(STATUS))
        STATUS = SMG$PUT_LINE(DISPLAY_ID,TRIM_STR(1:STR_LEN),,
1          SMG$M_REVERSE,0,,)
        IF (.NOT. STATUS) CALL LIB$STOP(%VAL(STATUS))
        END

```

The output generated by this Fortran example is shown in Figure SMG-9.

SMG\$ Routines
SMG\$CREATE_VIRTUAL_DISPLAY

Figure SMG-9 Output of Fortran Program Calling SMG\$CREATE_VIRTUAL_DISPLAY



ZK-4100-GE

SMG\$CREATE_VIRTUAL_KEYBOARD

Create a Virtual Keyboard

The Create a Virtual Keyboard routine creates a virtual keyboard and returns its assigned keyboard identifier.

Format

```
SMG$CREATE_VIRTUAL_KEYBOARD keyboard-id [,input-device] [,default-filespec]
                             [,resultant-filespec] [,recall-size]
```

Returns

OpenVMS usage: cond_value
type: longword (unsigned)
access: write only
mechanism: by value

Arguments

keyboard-id

OpenVMS usage: identifier
type: longword (unsigned)
access: write only
mechanism: by reference

Receives the keyboard identifier of the newly created virtual keyboard. The **keyboard-id** argument is the address of an unsigned longword into which is written the keyboard identifier.

input-device

OpenVMS usage: char_string
type: character string
access: read only
mechanism: by descriptor

String containing the file specification or logical name of the file or terminal to be used for this virtual keyboard. The **input-device** argument is the address of a descriptor pointing to the file specification. If omitted, this defaults to SYSS\$INPUT.

default-filespec

OpenVMS usage: char_string
type: character string
access: read only
mechanism: by descriptor

String containing the default file specification. The **default-filespec** argument is the address of a descriptor pointing to the default file specification. If omitted, the null string is used.

The **default-filespec** argument might be used to specify a default device and directory, leaving the **input-device** argument to supply the file name and type.

SMG\$ Routines

SMG\$CREATE_VIRTUAL_KEYBOARD

resultant-filespec

OpenVMS usage: char_string
type: character string
access: write only
mechanism: by descriptor

String into which the procedure writes the fully expanded file specification of the file used. The **resultant-filespec** argument is the address of a descriptor pointing to the string into which is written the file specification that was used.

recall-size

OpenVMS usage: byte_unsigned
type: byte (unsigned)
access: read only
mechanism: by reference

Number of input lines to be saved for later recall. The optional **recall-size** argument is the address of an unsigned byte containing the specified number of lines. A value of 0 turns off input line recall. By default, 20 lines are saved for later recall.

Description

SMG\$CREATE_VIRTUAL_KEYBOARD creates the association between a file specification (terminal name or OpenVMS RMS file) and a virtual keyboard. The keyboard identifier is then passed to other SMG\$ procedures in order to identify the input stream being acted upon.

If your program also calls the routine SMG\$CREATE_PASTEBOARD, be sure to call that routine *before* you call SMG\$CREATE_VIRTUAL_KEYBOARD.

If **input-device** does not refer to a terminal, the file is opened using RMS and all further access to that file is performed through RMS. If **input-device** is a terminal, this procedure assigns a channel to the terminal and sets the terminal's keyboard to application mode (if supported). These attributes are restored to their previous values when the virtual keyboard is deleted. The virtual keyboard is deleted automatically when the image exits and can also be deleted by a call to SMG\$DELETE_VIRTUAL_KEYBOARD.

Condition Values Returned

| | |
|-----------------|---|
| SS\$NORMAL | Normal successful completion. |
| SMG\$_FILTOOLON | File specification is too long (over 255 characters). |
| SMG\$_WRONUMARG | Wrong number of arguments. |
| LIB\$_INSEF | Insufficient number of event flags. |
| LIB\$_INSVIRMEM | Insufficient virtual memory. |
| LIB\$_INVSTRDES | Invalid string descriptor. |

Any RMS condition values returned by \$OPEN or \$CONNECT.

Any condition values returned by \$GETDVIW, \$ASSIGN, or \$DCLEXH.

SMG\$ Routines SMG\$CREATE_VIRTUAL_KEYBOARD

Example

```
C+
C This Fortran example program demonstrates the use of
C SMG$CREATE_VIRTUAL_KEYBOARD, SMG$CREATE_KEY_TABLE,
C SMG$ADD_KEY_DEF, and SMG$READ_COMPOSED_LINE.
C-

      INTEGER SMG$CREATE_VIRTUAL_KEYBOARD, SMG$CREATE_KEY_TABLE
      INTEGER SMG$ADD_KEY_DEF, SMG$READ_COMPOSED_LINE
      INTEGER SMG$DELETE_KEY_DEF, KEYBOARD, KEYTABLE, STATUS

C+
C Include the SMG definitions. In particular, we want SMG$M_KEY_NOECHO
C and SMG$M_KEY_TERMINATE.
C-

      INCLUDE '($SMGDEF)'

C+
C Create a virtual keyboard (using SMG$CREATE_VIRTUAL_KEYBOARD)
C and create a key table (using SMG$CREATE_KEY_TABLE).
C-

      STATUS = SMG$CREATE_VIRTUAL_KEYBOARD (KEYBOARD)
      IF (.NOT. STATUS) CALL LIB$SIGNAL(%VAL(STATUS))

      STATUS = SMG$CREATE_KEY_TABLE (KEYTABLE)
      IF (.NOT. STATUS) CALL LIB$SIGNAL(%VAL(STATUS))

C+
C Prompt the user with the following instructions.
C-

      WRITE (6,*) 'When you see the prompt (->), strike the following'
      WRITE (6,*) 'keys (on the KEYPAD): '
      WRITE (6,*) '          PF1 '
      WRITE (6,*) '          5 '
      WRITE (6,*) '          PF3 '
      WRITE (6,*) ' '
      WRITE (6,*) 'When you have done this, the following sentence'
      WRITE (6,*) '(and nothing more) should appear following the'
      WRITE (6,*) 'prompt: '
      WRITE (6,*) '(PF3 should act as a carriage return.)'
      WRITE (6,*) ' '
      WRITE (6,*) 'NOW IS THE TIME FOR ALL TEXT TO APPEAR.'

C+
C Add key definitions by calling SMG$ADD_KEY_DEF.
C-

      STATUS = SMG$ADD_KEY_DEF (KEYTABLE, 'PF1', , ,
1 'NOW IS THE TIME FOR ')
      IF (.NOT. STATUS) CALL LIB$SIGNAL(%VAL(STATUS))

      STATUS = SMG$ADD_KEY_DEF (KEYTABLE, 'KP5', , ,
1 'TEXT TO APPEAR.')
      IF (.NOT. STATUS) CALL LIB$SIGNAL(%VAL(STATUS))

      STATUS = SMG$ADD_KEY_DEF (KEYTABLE, 'PF3', , ,
1 SMG$M_KEY_NOECHO + SMG$M_KEY_TERMINATE ,
1 'THIS SHOULD NOT BE ECHOED. IF YOU CAN
1 SEE THIS, AN ERROR EXISTS.')
      IF (.NOT. STATUS) CALL LIB$SIGNAL(%VAL(STATUS))

C+
C Call SMG$READ_COMPOSED_LINE to read a line of input.
C-
```

SMG\$ Routines

SMG\$CREATE_VIRTUAL_KEYBOARD

```
        WRITE(6,*) ' '
        STATUS = SMG$READ_COMPOSED_LINE (KEYBOARD, KEYTABLE, R_TEXT,
1      '->')
        IF (.NOT. STATUS) CALL LIB$SIGNAL(%VAL(STATUS))
        END
```

Output session:

\$ RUN example

When you see the prompt (->), strike the following keys (on the KEYPAD):

```
        PF1
         5
        PF3
```

When you have done this, the following sentence (and nothing more) should appear following the prompt:

(PF3 should act as a carriage return.)

NOW IS THE TIME FOR ALL TEXT TO APPEAR.

->NOW IS THE TIME FOR ALL TEXT TO APPEAR.

\$

SMG\$CURSOR_COLUMN

Return Cursor Column Position

The Return Cursor Column Position routine returns the virtual cursor's current column position in a specified virtual display.

Format

SMG\$CURSOR_COLUMN display-id

Returns

OpenVMS usage: longword_unsigned
type: longword (unsigned)
access: write only
mechanism: by value

SMG\$CURSOR_COLUMN returns the current virtual cursor column position.

Argument

display-id
OpenVMS usage: identifier
type: longword (unsigned)
access: read only
mechanism: by reference

The display for which the column position is returned. The **display-id** argument is the address of an unsigned longword that contains the display identifier.

The display identifier is returned by SMG\$CREATE_VIRTUAL_DISPLAY.

Description

SMG\$CURSOR_COLUMN returns a longword containing the value of the current virtual cursor column position for the specified virtual display. If the **display-id** is omitted, this routine signals SMG\$_WRONUMARG. If the **display-id** is invalid, this routine signals SMG\$_INVDIS_ID.

Condition Values Signaled

| | |
|-----------------|-----------------------------|
| SMG\$_INVDIS_ID | Invalid display-id . |
| SMG\$_WRONUMARG | Wrong number of arguments. |

SMG\$CURSOR_ROW

Return Cursor Row Position

The Return Cursor Row Position routine returns the virtual cursor's current row position in a specified virtual display.

Format

SMG\$CURSOR_ROW display-id

Returns

OpenVMS usage: longword_unsigned
type: longword (unsigned)
access: write only
mechanism: by value

SMG\$CURSOR_ROW returns the current row position.

Argument

display-id
OpenVMS usage: identifier
type: longword (unsigned)
access: read only
mechanism: by reference

The display for which the row position is returned. The **display-id** argument is the address of an unsigned longword that contains the display identifier.

The display identifier is returned by SMG\$CREATE_VIRTUAL_DISPLAY.

Description

SMG\$CURSOR_ROW returns a longword containing the value of the current virtual cursor row position for the specified virtual display. If the **display-id** is omitted, this routine signals SMG\$_WRONUMARG. If the **display-id** is invalid, this routine signals SMG\$_INVDIS_ID.

Condition Values Signaled

| | |
|-----------------|-----------------------------|
| SMG\$_INVDIS_ID | Invalid display-id . |
| SMG\$_WRONUMARG | Wrong number of arguments. |

SMG\$DEFINE_KEY

Perform a DEFINE/KEY Command

The Perform a DEFINE/KEY Command routine performs the DEFINE/KEY command you provide.

Format

SMG\$DEFINE_KEY key-table-id ,command-string

Returns

OpenVMS usage: cond_value
 type: longword (unsigned)
 access: write only
 mechanism: by value

Arguments

key-table-id

OpenVMS usage: identifier
 type: longword (unsigned)
 access: read only
 mechanism: by reference

Identifies the key definition table for which the DEFINE/KEY command is to be performed. The **key-table-id** argument is the address of an unsigned longword that contains the key table identifier.

The key table identifier is returned by SMG\$CREATE_KEY_TABLE.

command-string

OpenVMS usage: char_string
 type: character string
 access: read only
 mechanism: by descriptor

String containing the DEFINE/KEY command to be performed. The **command-string** argument is the address of a descriptor pointing to the command to be performed.

The valid qualifiers for the DEFINE/KEY command are as follows:

- /TERMINATE
- /NOECHO
- /LOCK
- /IF_STATE
- /SET_STATE

The following two restrictions apply to the DEFINE/KEY qualifiers:

- If you use the /LOCK qualifier, you must also use the /SET_STATE qualifier.
- If you use both the /SET_STATE and /TERMINATE qualifiers, you may not use /LOCK.

SMG\$ Routines

SMG\$DEFINE_KEY

Description

SMG\$DEFINE_KEY parses and performs a DEFINE/KEY command. It can be used by programs that accept DEFINE/KEY commands but do not parse the commands themselves.

SMG\$DEFINE_KEY calls CLISDCL_PARSE to parse the command line and then makes the appropriate call to SMG\$ADD_KEY_DEF. The original command is then restored with a call to CLISDCL_PARSE. Use of this procedure requires that the image be run under the DCL command language interpreter (CLI).

Condition Values Returned

SSS_NORMAL Normal successful completion.

SMG\$_WRONUMARG Wrong number of arguments.

Any condition values returned by LIB\$SCOPY_DXDX.

Any condition values returned by CLIS routines.

Any condition values returned by SMG\$ADD_KEY_DEF.

SMG\$DELETE_CHARS

Delete Characters

The Delete Characters routine deletes characters in a virtual display.

Format

SMG\$DELETE_CHARS display-id ,number-of-characters ,start-row ,start-column

Returns

OpenVMS usage: cond_value
type: longword (unsigned)
access: write only
mechanism: by value

Arguments

display-id

OpenVMS usage: identifier
type: longword (unsigned)
access: read only
mechanism: by reference

Identifies the virtual display from which characters are to be deleted. The **display-id** argument is the address of an unsigned longword that contains the display identifier.

The display identifier is returned by SMG\$CREATE_VIRTUAL_DISPLAY.

number-of-characters

OpenVMS usage: longword_signed
type: longword (signed)
access: read only
mechanism: by reference

Specifies the number of characters to be deleted. The **number-of-characters** argument is the address of a signed longword that contains the number of characters to be deleted.

start-row

OpenVMS usage: longword_signed
type: longword (signed)
access: read only
mechanism: by reference

Specifies the row position at which to start the deletion. The **start-row** argument is the address of a signed longword that contains the row number at which to start the deletion.

start-column

OpenVMS usage: longword_signed
type: longword (signed)
access: read only
mechanism: by reference

SMG\$ Routines

SMG\$DELETE_CHARS

Specifies the column position at which to start the deletion. The **start-column** argument is the address of a signed longword that contains the column position at which to start the deletion.

Description

SMG\$DELETE_CHARS deletes a specified number of characters, starting at a specified row and column position. Remaining characters on the line are shifted to the left to occupy the vacated spaces. Note that this routine deletes characters only on a single line.

If you specify more characters than are available for deletion, SMG\$DELETE_CHARS deletes all characters from the specified column position to the end of the line.

This routine leaves the virtual cursor at the position of the first character deleted.

Condition Values Returned

| | |
|----------------|---|
| SS\$NORMAL | Normal successful completion. |
| SMG\$INVARG | Invalid argument. The number of characters specified extends outside the virtual display. |
| SMG\$INVCOL | Invalid column position. The specified column is outside the virtual display. |
| SMG\$INVDIS_ID | Invalid display-id . |
| SMG\$INVROW | Invalid row position. The specified row is outside the virtual display. |
| SMG\$WILUSERMS | Pasteboard is not a video terminal. |
| SMG\$WRONUMARG | Wrong number of arguments. |

Example

```
C+
C This Fortran example program demonstrates the use of
C SMG$DELETE_CHARS.
C-

      INTEGER SMG$CREATE_VIRTUAL_DISPLAY, SMG$CREATE_PASTEBOARD
      INTEGER SMG$PASTE_VIRTUAL_DISPLAY, SMG$PUT_CHARS
      INTEGER SMG$DELETE_CHARS, DISPLAY1, PASTE1
      INTEGER ROWS, COLUMNS, BORDER, STATUS

C+
C Create the virtual display by calling SMG$CREATE_VIRTUAL_DISPLAY.
C To give it a border, set BORDER = 1. No border would be BORDER = 0.
C-

      ROWS = 7
      COLUMNS = 50
      BORDER = 1

      STATUS = SMG$CREATE_VIRTUAL_DISPLAY
1      (ROWS, COLUMNS, DISPLAY1, BORDER)
      IF (.NOT. STATUS) CALL LIB$SIGNAL(%VAL(STATUS))

C+
C Call SMG$CREATE_PASTEBOARD to create the pasteboard.
C-

      STATUS = SMG$CREATE_PASTEBOARD (PASTE1)
      IF (.NOT. STATUS) CALL LIB$SIGNAL(%VAL(STATUS))
```

SMG\$ Routines SMG\$DELETE_CHARS

```
C+
C Use SMG$PUT_CHARS to put data in the virtual display.
C-
      STATUS = SMG$PUT_CHARS ( DISPLAY1,
1      ' This virtual display has 7 rows and 50 columns.', 2, 1)
      IF (.NOT. STATUS) CALL LIB$SIGNAL(%VAL(STATUS))

      STATUS = SMG$PUT_CHARS ( DISPLAY1,
1      ' This is a bordered virtual display.', 4, 1)
      IF (.NOT. STATUS) CALL LIB$SIGNAL(%VAL(STATUS))

      STATUS = SMG$PUT_CHARS ( DISPLAY1,
1      ' SMG$PUT_CHARS puts data in this virtual display.', 6, 1)
      IF (.NOT. STATUS) CALL LIB$SIGNAL(%VAL(STATUS))

C+
C Paste the virtual display to the pasteboard using
C SMG$PASTE_VIRTUAL_DISPLAY.
C-
      STATUS = SMG$PASTE_VIRTUAL_DISPLAY ( DISPLAY1, PASTE1, 4, 15)
      IF (.NOT. STATUS) CALL LIB$SIGNAL(%VAL(STATUS))

C+
C Call SMG$DELETE_CHARS to delete 4 characters from row 4
C starting from character (column) 14, removing the characters
C "rder" from the word "bordered".
C-
      STATUS = SMG$DELETE_CHARS ( DISPLAY1, 4, 4, 14)
      IF (.NOT. STATUS) CALL LIB$SIGNAL(%VAL(STATUS))

      END
```

The output generated by this Fortran program before the call to SMG\$DELETE_CHARS is shown in Figure SMG-10.

SMG\$ Routines
SMG\$DELETE_CHARS

Figure SMG-10 Output Generated Before the Call to SMG\$DELETE_CHARS

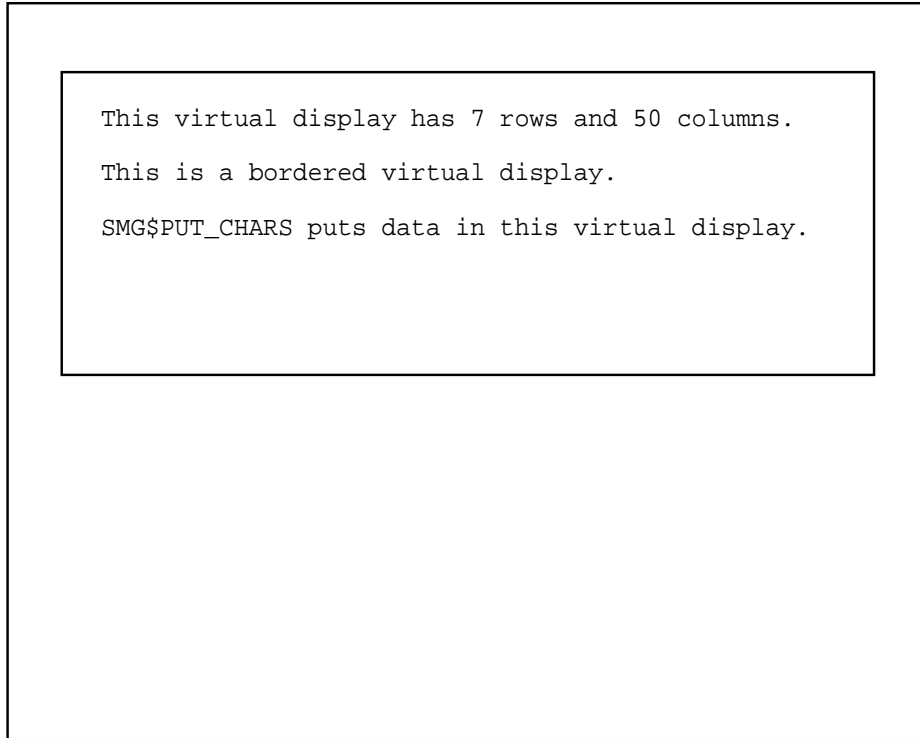

ZK-4101-GE

The output generated after the call to SMG\$DELETE_CHARS is shown in Figure SMG-11.

Figure SMG-11 Output Generated After the Call to SMG\$DELETE_CHARS

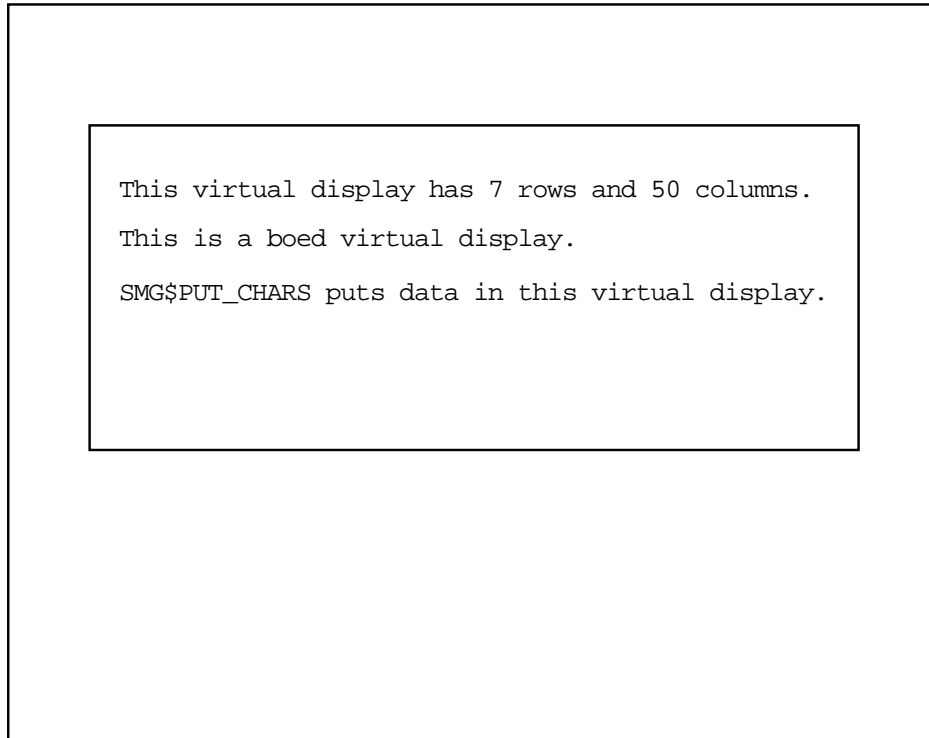

ZK-4107-GE

SMG\$DELETE_KEY_DEF

Delete Key Definition

The Delete Key Definition routine deletes a key definition from the specified table of key definitions.

Format

SMG\$DELETE_KEY_DEF key-table-id ,key-name [,if-state]

Returns

OpenVMS usage: cond_value
type: longword (unsigned)
access: write only
mechanism: by value

Arguments

key-table-id

OpenVMS usage: identifier
type: longword (unsigned)
access: read only
mechanism: by reference

Identifies the key table from which the key definition is deleted. The **key-table-id** argument is the address of an unsigned longword that contains the key table identifier.

key-name

OpenVMS usage: char_string
type: character string
access: read only
mechanism: by descriptor

String containing the name of the key whose definition is to be deleted. The **key-name** argument is the address of a descriptor pointing to the key name. The key name is stripped of trailing blanks and converted to uppercase before use.

Table 3-1 lists the valid key names.

if-state

OpenVMS usage: char_string
type: character string
access: read only
mechanism: by descriptor

String containing a state name that further qualifies **key-name**. The **if-state** argument is the address of a descriptor pointing to the state name. If omitted, the null state is used. Thus if a key has several definitions depending on various values of **if-state**, this routine lets you delete only one of those definitions.

Description

SMG\$DELETE_KEY_DEF deletes a key definition from the specified table of key definitions.

Condition Values Returned

| | |
|-----------------|-------------------------------|
| SS\$_NORMAL | Normal successful completion. |
| SMG\$_INVKEYNAM | Invalid key-name . |
| SMG\$_INVKTB_ID | Invalid key-table-id . |
| SMG\$_KEYDEFPRO | Key definition is protected. |
| SMG\$_KEYNOTDEF | Key is not defined. |
| SMG\$_WRONUMARG | Wrong number of arguments. |

SMG\$DELETE_LINE

Delete Line

The Delete Line routine deletes lines from a virtual display.

Format

SMG\$DELETE_LINE display-id ,start-row [,number-of-rows]

Returns

OpenVMS usage: cond_value
type: longword (unsigned)
access: write only
mechanism: by value

Arguments

display-id

OpenVMS usage: identifier
type: longword (unsigned)
access: read only
mechanism: by reference

Identifies the virtual display from which lines are to be deleted. The **display-id** argument is the address of an unsigned longword that contains the display identifier.

The display identifier is returned by SMG\$CREATE_VIRTUAL_DISPLAY.

start-row

OpenVMS usage: longword_signed
type: longword (signed)
access: read only
mechanism: by reference

Specifies the first line to be deleted from the virtual display. The **start-row** argument is the address of a signed longword that contains the number of the first line to be deleted.

number-of-rows

OpenVMS usage: longword_signed
type: longword (signed)
access: read only
mechanism: by reference

Specifies the number of lines to be deleted. The **number-of-rows** argument is the address of a signed longword that contains the number of lines to be deleted. If omitted, one line is deleted.

Description

SMG\$DELETE_LINE deletes one or more lines from a virtual display and scrolls the remaining lines up into the space created by the deletion. Blank lines fill the display on the bottom. The virtual cursor is left at the first column position in **start-row**.

Condition Values Returned

| | |
|----------------|-------------------------------------|
| SS\$NORMAL | Normal successful completion. |
| SMG\$INVARG | Invalid argument. |
| SMG\$INVDIS_ID | Invalid display-id . |
| SMG\$INVROW | Invalid row. |
| SMG\$WILUSERMS | Pasteboard is not a video terminal. |
| SMG\$WRONUMARG | Wrong number of arguments. |

Example

```

C+
C This Fortran example program demonstrates the use of SMG$DELETE_LINE.
C-

      IMPLICIT INTEGER (A-Z)

C+
C Create the virtual display by calling SMG$CREATE_VIRTUAL_DISPLAY.
C To give it a border, set BORDER = 1.  No border would be BORDER = 0.
C-

      ROWS = 7
      COLUMNS = 50
      BORDER = 1

      STATUS = SMG$CREATE_VIRTUAL_DISPLAY
1      (ROWS, COLUMNS, DISPLAY1, BORDER)
      IF (.NOT. STATUS) CALL LIB$SIGNAL(%VAL(STATUS))

C+
C Call SMG$CREATE_PASTEBOARD to create the pasteboard.
C-

      STATUS = SMG$CREATE_PASTEBOARD (PASTE1)
      IF (.NOT. STATUS) CALL LIB$SIGNAL(%VAL(STATUS))

C+
C Use SMG$PUT_CHARS to put data in the virtual display.
C-

      STATUS = SMG$PUT_CHARS ( DISPLAY1,
1      ' This virtual display has 7 rows and 50 columns.', 2, 1)
      IF (.NOT. STATUS) CALL LIB$SIGNAL(%VAL(STATUS))

      STATUS = SMG$PUT_CHARS ( DISPLAY1,
1      ' This is a bordered virtual display.', 4, 1)
      IF (.NOT. STATUS) CALL LIB$SIGNAL(%VAL(STATUS))

      STATUS = SMG$PUT_CHARS ( DISPLAY1,
1      ' SMG$PUT_CHARS puts data in this virtual display.', 6, 1)
      IF (.NOT. STATUS) CALL LIB$SIGNAL(%VAL(STATUS))

C+
C Paste the virtual display to the pasteboard using
C SMG$PASTE_VIRTUAL_DISPLAY.
C-

      STATUS = SMG$PASTE_VIRTUAL_DISPLAY ( DISPLAY1, PASTE1, 4, 15)
      IF (.NOT. STATUS) CALL LIB$SIGNAL(%VAL(STATUS))

```

SMG\$ Routines

SMG\$DELETE_LINE

```
C+
C Call SMG$DELETE_LINE to delete rows 3, 4, and 5.
C-

      STATUS = SMG$DELETE_LINE ( DISPLAY1, 3, 3)
      IF (.NOT. STATUS) CALL LIB$SIGNAL(%VAL(STATUS))

      END
```

The output generated by this Fortran program before the call to SMG\$DELETE_LINE is shown in Figure SMG-12.

Figure SMG-12 Output Generated by Fortran Program Before the Call to SMG\$DELETE_LINE

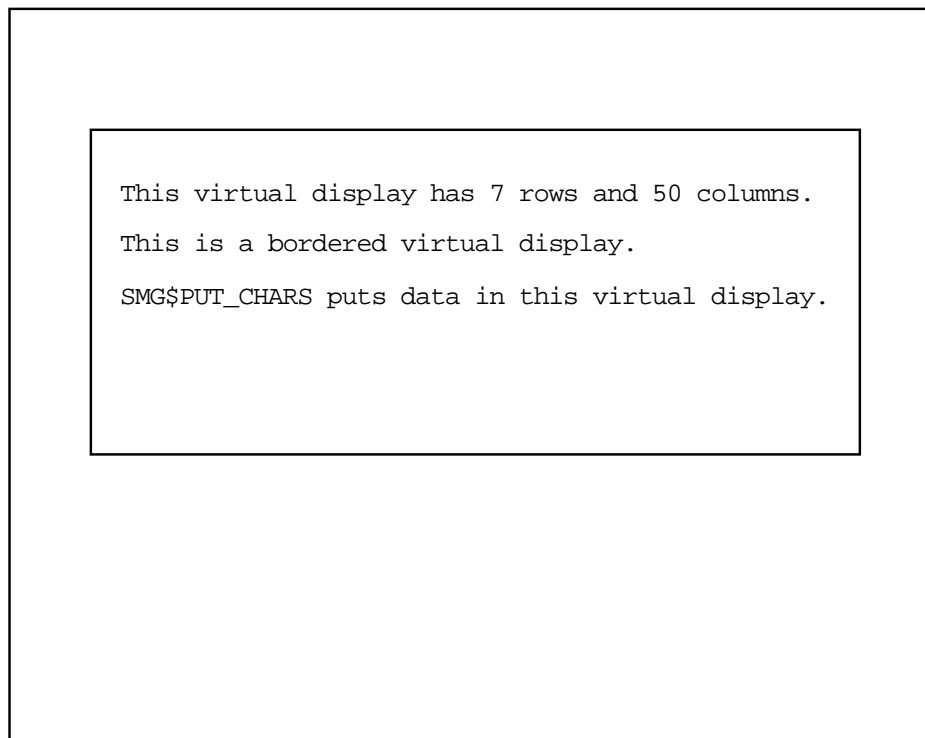

ZK-4103-GE

The output generated after the call to SMG\$DELETE_LINE is shown in Figure SMG-13.

Figure SMG-13 Output Generated After the Call to **SMG\$DELETE_LINE**

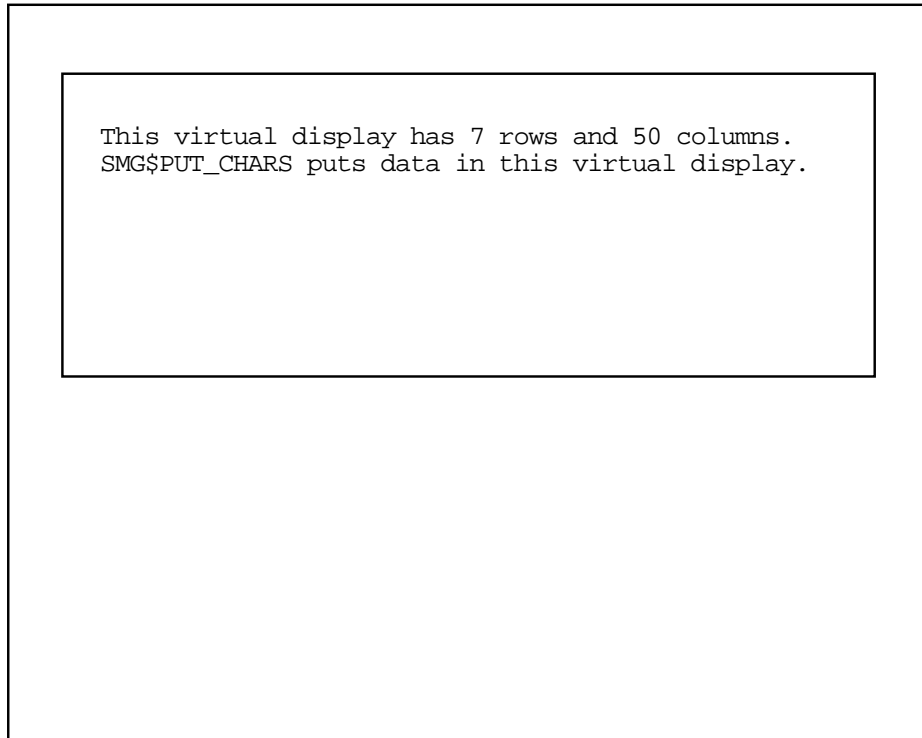

ZK-4109-GE

SMG\$DELETE_MENU

End Access to a Menu in the Virtual Display

The End Access to a Menu in the Virtual Display routine ends access to the menu choices in the specified virtual display.

Format

SMG\$DELETE_MENU display-id [,flags]

Returns

OpenVMS usage: cond_value
type: longword (unsigned)
access: write only
mechanism: by value

Arguments

display-id
OpenVMS usage: identifier
type: longword (unsigned)
access: read only
mechanism: by reference

Identifier of the virtual display in which the menu choices are displayed. The **display-id** argument is the address of an unsigned longword containing this identifier.

flags
OpenVMS usage: mask_longword
type: longword (unsigned)
access: read only
mechanism: by reference

Optional bit mask specifying possible actions to take when deleting the menu. The **flags** argument is the address of an unsigned longword that contains the flag. At this time, the only valid value is SMG\$M_ERASE_MENU. If this option is specified, all rows containing menu items are erased.

Description

SMG\$DELETE_MENU discontinues access to the menu choices in the specified virtual display. The optional **flags** argument lets you specify that the menu choices be removed from the display when the menu is deleted.

Condition Values Returned

| | |
|------------|---|
| SS\$NORMAL | Normal successful completion. |
| LIB\$_xxxx | Any condition value returned by LIB\$FREE_VM. |
| SMG\$_xxxx | Any condition value returned by SMG\$ERASE_DISPLAY. |

SMG\$DELETE_PASTEBOARD

Delete Pasteboard

The Delete Pasteboard routine deletes a pasteboard.

Format

SMG\$DELETE_PASTEBOARD pasteboard-id [,flags]

Returns

OpenVMS usage: cond_value
type: longword (unsigned)
access: write only
mechanism: by value

Arguments

pasteboard-id

OpenVMS usage: identifier
type: longword (unsigned)
access: read only
mechanism: by reference

Specifies the pasteboard to be deleted. The **pasteboard-id** argument is the address of an unsigned longword that contains the pasteboard identifier.

The pasteboard identifier is returned by SMG\$CREATE_PASTEBOARD.

flags

OpenVMS usage: mask_longword
type: longword (unsigned)
access: read only
mechanism: by reference

Optional bit mask specifying whether the screen is cleared after the specified pasteboard is deleted. The **flags** argument is the address of an unsigned longword that contains the flag. Valid values are as follows:

| | |
|-----------------------|---|
| 0 | Does not clear the screen. |
| SMG\$M_ERASE_PBD | Clears the screen (default). |
| SMG\$M_IGNORE_BATCHED | Deletes the pasteboard even if batching is in effect. |

Description

SMG\$DELETE_PASTEBOARD flushes all output to the display, terminates all use of the specified pasteboard, and deallocates all resources associated with the pasteboard.

SMG\$ Routines

SMG\$DELETE_PASTEBOARD

Condition Values Returned

| | |
|-----------------|--|
| SS\$_NORMAL | Normal successful completion. |
| SMG\$_INVPAS_ID | Invalid pasteboard-id . |
| SMG\$_NOTPASTED | The specified virtual display is not pasted to the specified pasteboard. |
| SMG\$_WILUSERMS | Pasteboard is not a video terminal. |
| SMG\$_WRONUMARG | Wrong number of arguments. |

Any condition values returned by \$DASSGN, LIB\$FREE_VM, LIB\$FREE_EF, or SMG\$FLUSH_BUFFER.

SMG\$DELETE_SUBPROCESS

Terminate a Subprocess

The Terminate a Subprocess routine deletes a subprocess that was created with the SMG\$CREATE_SUBPROCESS routine.

Format

SMG\$DELETE_SUBPROCESS display-id

Returns

OpenVMS usage: cond_value
type: longword (unsigned)
access: write only
mechanism: by value

Argument

display-id
OpenVMS usage: identifier
type: longword (unsigned)
access: read only
mechanism: by reference

Identifier of the virtual display associated with the subprocess being deleted. The **display-id** argument is the address of an unsigned longword that contains this virtual display identifier.

Description

SMG\$DELETE_SUBPROCESS deletes a subprocess that was created by a call to SMG\$CREATE_SUBPROCESS. Because the Screen Management Facility provides its own exit handlers, do not invoke SMG\$DELETE_SUBPROCESS from within your own exit handler. For more information, see Section 4.4.

Condition Values Returned

| | |
|-----------------|--------------------------------------|
| SS\$_NORMAL | Normal successful completion. |
| SS\$_xxxx | Any status returned by \$DELPRC. |
| SMG\$_INVDIS_ID | Invalid display-id . |
| SMG\$_NOSUBEXI | No subprocess exists. |
| LIB\$_xxxx | Any status returned by LIB\$FREE_VM. |

SMG\$DELETE_VIEWPORT

Delete a Viewport

The Delete a Viewport routine deletes the specified viewport from any pasteboards to which it is pasted.

Format

SMG\$DELETE_VIEWPORT display-id

Returns

OpenVMS usage: cond_value
type: longword (unsigned)
access: write only
mechanism: by value

Argument

display-id
OpenVMS usage: identifier
type: longword (unsigned)
access: read only
mechanism: by reference

Identifier of the virtual display associated with the viewport to be deleted. The **display-id** argument is the address of an unsigned longword containing the display identifier.

Description

SMG\$DELETE_VIEWPORT deletes a viewport. The viewport is automatically “unpasted” from any pasteboards to which it is pasted. However, the virtual display associated with the deleted viewport has not been deleted. To view this virtual display, you must paste it to the pasteboard with the SMG\$PASTE_VIRTUAL_DISPLAY routine. To delete this virtual display, use the SMG\$DELETE_VIRTUAL_DISPLAY routine.

Condition Values Returned

| | |
|------------------|--|
| SS\$NORMAL | Normal successful completion. |
| SMG\$INVDIS_ID | Invalid display-id . |
| SMG\$NO_WINASSOC | No viewport associated with the virtual display. |
| SMG\$WRONUMARG | Wrong number of arguments. |

SMG\$DELETE_VIRTUAL_DISPLAY

Delete Virtual Display

The Delete Virtual Display routine deletes a virtual display.

Format

SMG\$DELETE_VIRTUAL_DISPLAY display-id

Returns

OpenVMS usage: cond_value
type: longword (unsigned)
access: write only
mechanism: by value

Argument

display-id
OpenVMS usage: identifier
type: longword (unsigned)
access: read only
mechanism: by reference

Specifies the virtual display to be deleted. The **display-id** argument is the address of an unsigned longword that contains the display identifier.

The display identifier **display-id** is returned by SMG\$CREATE_VIRTUAL_DISPLAY.

Description

SMG\$DELETE_VIRTUAL_DISPLAY deletes a virtual display and removes it from any pasteboard on which it is pasted. It also deallocates any buffer space associated with the virtual display.

Condition Values Returned

| | |
|----------------|--|
| SS\$NORMAL | Normal successful completion. |
| SMG\$INVDIS_ID | Invalid display-id . |
| SMG\$NOTPASTED | The specified virtual display is not pasted to the specified pasteboard. |
| SMG\$WILUSERMS | Pasteboard is not a video terminal. |
| SMG\$WRONUMARG | Wrong number of arguments. |

Any condition values returned by LIB\$FREE_VM.

SMG\$ Routines

SMG\$DELETE_VIRTUAL_KEYBOARD

SMG\$DELETE_VIRTUAL_KEYBOARD

Delete Virtual Keyboard

The Delete Virtual Keyboard routine deletes a virtual keyboard.

Format

SMG\$DELETE_VIRTUAL_KEYBOARD keyboard-id

Returns

OpenVMS usage: cond_value
type: longword (unsigned)
access: write only
mechanism: by value

Argument

keyboard-id
OpenVMS usage: identifier
type: longword (unsigned)
access: read only
mechanism: by reference

Specifies the virtual keyboard to be deleted. The **keyboard-id** argument is the address of an unsigned longword that contains the keyboard identifier.

The keyboard identifier is returned by SMG\$CREATE_VIRTUAL_KEYBOARD.

Description

SMG\$DELETE_VIRTUAL_KEYBOARD deletes a virtual keyboard. Any terminal attributes specified when the keyboard was created are reset to their previous values and the keypad mode (numeric or application) is reset to its original state. In addition, the channel is deassigned and, if the virtual keyboard was a file, the file is closed.

Because SMG\$ provides its own exit handlers, this routine should not be called from your own exit handler. For more information, see Section 4.4.

Condition Values Returned

| | |
|-----------------|-------------------------------|
| SS\$NORMAL | Normal successful completion. |
| SMG\$_INVKBD_ID | Invalid keyboard-id . |
| SMG\$_WRONUMARG | Wrong number of arguments. |

SMG\$DEL_TERM_TABLE

Delete Terminal Table

The Delete Terminal Table routine terminates access to a private TERMTABLE.EXE and frees the associated virtual address space.

Format

SMG\$DEL_TERM_TABLE

Returns

OpenVMS usage: cond_value
type: longword (unsigned)
access: write only
mechanism: by value

Arguments

None.

Description

SMG\$DEL_TERM_TABLE terminates access to a private TERMTABLE.EXE. Calling this routine is optional. This routine is useful in the case where a calling program might need to reuse the virtual address space used by a private TERMTABLE. This routine should be used only when you perform direct (non-SMG\$) I/O to terminals.

Condition Values Returned

| | |
|------------|-------------------------------|
| SS\$NORMAL | Normal successful completion. |
|------------|-------------------------------|

SMG\$DISABLE_BROADCAST_TRAPPING

Disable Broadcast Trapping

The Disable Broadcast Trapping routine disables trapping of broadcast messages for the specified terminal.

Format

SMG\$DISABLE_BROADCAST_TRAPPING pasteboard-id

Returns

OpenVMS usage: cond_value
type: longword (unsigned)
access: write only
mechanism: by value

Argument

pasteboard-id
OpenVMS usage: identifier
type: longword (unsigned)
access: read only
mechanism: by reference

Specifies the pasteboard for the terminal to be affected. The **pasteboard-id** argument is the address of an unsigned longword that contains the pasteboard identifier.

Description

SMG\$DISABLE_BROADCAST_TRAPPING disables trapping of broadcast messages for the specified terminal. SMG\$DISABLE_BROADCAST_TRAPPING deassigns the mailbox set with SMG\$SET_BROADCAST_TRAPPING, resets the terminal characteristics, and therefore allows the user to call LIBSSPAWN. This routine must be used to disable any broadcast trapping set with the routine SMG\$SET_BROADCAST_TRAPPING.

When you disable broadcast trapping, any broadcast messages that have been queued to the terminal are lost. If you enable broadcast trapping with SMG\$SET_BROADCAST_TRAPPING but do not disable it with SMG\$DISABLE_BROADCAST_TRAPPING before the image exits, any messages that have been broadcast to the terminal are lost when the image exits.

Note that if both broadcast trapping and the trapping of unsolicited input are enabled, then both SMG\$DISABLE_BROADCAST_TRAPPING and SMG\$DISABLE_UN SOLICITED_INPUT must be invoked to deassign the mailbox.

Condition Values Returned

| | |
|-----------------|-------------------------------|
| SSS_NORMAL | Normal successful completion. |
| SMG\$_WRONUMARG | Wrong number of arguments. |

Any condition value returned by \$QIOW.

SMG\$ Routines SMG\$DISABLE_BROADCAST_TRAPPING

Example

```
10      !+
      !This VAX BASIC program creates three virtual displays on
      !one pasteboard.
      !
      !The first virtual display contains instructions for the user,
      !the second shows trapped unsolicited input, and the third
      !lists trapped broadcast messages. The program sits in an
      !infinite loop until the user types a Ctrl/Z.
      !
      !When the program traps unsolicited input, both broadcast message
      !and unsolicited input trapping are disabled, and a subprocess
      !is spawned which executes the trapped user input.
      !
      !When control returns to the main process, broadcast trapping and
      !the trapping of unsolicited input are both reenabled. If the
      !unsolicited input which is trapped is a Ctrl/Z, the program exits.
      !-

      OPTION TYPE = EXPLICIT

      !+
      !Declaration of all routines called by the main program.
      !-

      %INCLUDE "LIB$ROUTINES" %FROM %LIBRARY "SYS$LIBRARY:BASIC$STARLET"
      %INCLUDE "SMG$ROUTINES" %FROM %LIBRARY "SYS$LIBRARY:BASIC$STARLET"

      !+
      !Declaration of the two AST routines:
      !GET_MSG is called when a broadcast message is trapped
      !GET_INPUT is called when there is unsolicited input
      !GET_INPUT is the routine which spawns the subprocess
      !-

      EXTERNAL INTEGER GET_MSG
      EXTERNAL INTEGER GET_INPUT

      DECLARE LONG pb_id, ret_status, display_id, display2_id, display3_id, &
                key_id, key_tab_id, counter

      !+
      !Create a MAP area for variables which must be shared between the
      !main program and the AST routines.
      !-

      MAP (params) LONG disp_info(2), LONG keyboard_info(4), LONG done_flag

      DECLARE STRING CONSTANT top_label = "User Input"
      DECLARE STRING CONSTANT ins_label = "Instructions"
      DECLARE STRING CONSTANT msg_label = "Messages"
      DECLARE STRING CONSTANT instr_0 = "Type commands to fill INPUT display."
      DECLARE STRING CONSTANT instr_1 = "Type Ctrl/T to fill MESSAGES display."
      DECLARE STRING CONSTANT instr_2 = "Type Ctrl/Z to exit."
      DECLARE LONG CONSTANT  advance = 1

      %INCLUDE "$SMGDEF" %FROM %LIBRARY "SYS$LIBRARY:BASIC$STARLET"
      %INCLUDE "$SMGMSG" %FROM %LIBRARY "SYS$LIBRARY:BASIC$STARLET"

      !+
      !The done_flag variable is clear (0) unless the user input was
      !a Ctrl/Z. In that case, the program exits.
      !-
      done_flag = 0

      !+
      !Create the pasteboard and the virtual keyboard
      !-
```

SMG\$ Routines

SMG\$DISABLE_BROADCAST_TRAPPING

```
ret_status = SMG$CREATE_PASTEBOARD (pb_id)
IF (ret_status AND 1%) = 0% THEN
    CALL LIB$STOP(ret_status BY VALUE)
END IF

!+
!This is one of the values which must be stored in the MAP area.
!-

disp_info(0) = pb_id

ret_status = SMG$CREATE_VIRTUAL_KEYBOARD (key_id)
IF (ret_status AND 1%) = 0% THEN
    CALL LIB$STOP(ret_status BY VALUE)
END IF

ret_status = SMG$CREATE_KEY_TABLE (key_tab_id)
IF (ret_status AND 1%) = 0% THEN
    CALL LIB$STOP(ret_status BY VALUE)
END IF

!+
!Create the three virtual displays
!-

ret_status = SMG$CREATE_VIRTUAL_DISPLAY(3 BY REF, 75 BY REF, &
    display3_id, SMG$M_BORDER BY REF, SMG$M_REVERSE BY REF)
IF (ret_status AND 1%) = 0% THEN
    CALL LIB$STOP(ret_status BY VALUE)
END IF

ret_status = SMG$CREATE_VIRTUAL_DISPLAY(6 BY REF, 75 BY REF, &
    display_id, SMG$M_BORDER BY REF, SMG$M_REVERSE BY REF)
IF (ret_status AND 1%) = 0% THEN
    CALL LIB$STOP(ret_status BY VALUE)
END IF

ret_status = SMG$CREATE_VIRTUAL_DISPLAY(6 BY REF, 75 BY REF, &
    display2_id, SMG$M_BORDER BY REF, SMG$M_REVERSE BY REF)
IF (ret_status AND 1%) = 0% THEN
    CALL LIB$STOP(ret_status BY VALUE)
END IF

!+
!The disp_info and keyboard_info arrays are required in the MAP.
!-
disp_info(1) = display2_id

keyboard_info(0) = key_id
keyboard_info(1) = key_tab_id
keyboard_info(2) = display_id
keyboard_info(4) = pb_id

!+
!Put Label borders around the three virtual displays.
!-

ret_status = SMG$LABEL_BORDER (display3_id, ins_label,,, &
    SMG$M_BOLD BY REF, SMG$M_REVERSE BY REF)
IF (ret_status AND 1%) = 0% THEN
    CALL LIB$STOP(ret_status BY VALUE)
END IF

ret_status = SMG$LABEL_BORDER (display_id, top_label,,, &
    SMG$M_BOLD BY REF,)
IF (ret_status AND 1%) = 0% THEN
    CALL LIB$STOP(ret_status BY VALUE)
END IF
```

SMG\$ Routines

SMG\$DISABLE_BROADCAST_TRAPPING

```
ret_status = SMG$LABEL_BORDER (display2_id, msg_label,,, &
    SMG$m_BOLD BY REF,)
IF (ret_status AND 1%) = 0% THEN
    CALL LIB$STOP(ret_status BY VALUE)
END IF

!+
!Fill the INSTRUCTIONS virtual display with user instructions.
!-

ret_status = SMG$PUT_LINE(display3_id, instr_0, &
advance,,, smg$m_wrap_char)
IF (ret_status AND 1%) = 0% THEN
    CALL LIB$STOP(ret_status BY VALUE)
END IF

ret_status = SMG$PUT_LINE(display3_id, instr_1, &
advance,,, smg$m_wrap_char)
IF (ret_status AND 1%) = 0% THEN
    CALL LIB$STOP(ret_status BY VALUE)
END IF

ret_status = SMG$PUT_LINE(display3_id, instr_2, &
advance,,, smg$m_wrap_char)
IF (ret_status AND 1%) = 0% THEN
    CALL LIB$STOP(ret_status BY VALUE)
END IF

!+
!Paste the virtual displays to the screen.
!-

ret_status = SMG$PASTE_VIRTUAL_DISPLAY(display3_id, pb_id, &
    2 BY REF, 4 BY REF)
IF (ret_status AND 1%) = 0% THEN
    CALL LIB$STOP(ret_status BY VALUE)
END IF

ret_status = SMG$PASTE_VIRTUAL_DISPLAY(display_id, pb_id, &
    8 BY REF, 4 BY REF)
IF (ret_status AND 1%) = 0% THEN
    CALL LIB$STOP(ret_status BY VALUE)
END IF

ret_status = SMG$PASTE_VIRTUAL_DISPLAY(display2_id, pb_id, &
    18 BY REF, 4 BY REF)
IF (ret_status AND 1%) = 0% THEN
    CALL LIB$STOP(ret_status BY VALUE)
END IF

!+
!Enable the trapping of unsolicited input. GET_INPUT is the
!AST procedure that is called when unsolicited input is
!received. This AST has one parameter, passed as null.
!-

ret_status = SMG$ENABLE_UNSOLICITED_INPUT(pb_id, LOC(GET_INPUT))
IF (ret_status AND 1%) = 0% THEN
    CALL LIB$STOP(ret_status BY VALUE)
END IF

!+
!Enable the trapping of broadcast messages. GET_MSG is the
!AST which is called when broadcast messages are received.
!This AST outputs the trapped message into the MESSAGES display.
!-
```

SMG\$ Routines

SMG\$DISABLE_BROADCAST_TRAPPING

```

ret_status = SMG$SET_BROADCAST_TRAPPING(pb_id, LOC(GET_MSG))
IF (ret_status AND 1%) = 0% THEN
    CALL LIB$STOP(ret_status BY VALUE)
END IF

!+
!This loop continually executes until done_flag is set to 1.
!Done_flag is set to 1 when the user input is a Ctrl/Z.
!If done_flag is 1, delete the pasteboard and exit the program.
!-

Infinite_loop:
IF done_flag = 0 THEN
    GOTO infinite_loop
ELSE
    ret_status = SMG$DELETE_PASTEBOARD (pb_id)
    GOTO all_done
END IF

All_done:
END

20    !+
!Start of AST routine GET_INPUT. This AST is called whenever there
!is unsolicited input. The unsolicited input is displayed in the
!INPUT virtual display, and if this input is not Ctrl/Z, a subprocess
!is spawned and the input command is executed. While this spawned
!subprocess is executing, broadcast and unsolicited input trapping
!are disabled.
!-

SUB GET_INPUT (paste_id, param, nl_1, nl_2, nl_3, nl_4)
MAP (params) LONG disp_info(2), LONG keyboard_info(4), LONG done_flag
DECLARE LONG z_status, status2, keybd_id, keybd_tab_id, disp_id, &
    pastebd, new_display, spawn_status
DECLARE WORD msg2_len
DECLARE STRING msg2
DECLARE LONG CONSTANT next_line = 1

%INCLUDE "SMG$ROUTINES" %FROM %LIBRARY "SYS$LIBRARY:BASIC$STARLET"
%INCLUDE "LIB$ROUTINES" %FROM %LIBRARY "SYS$LIBRARY:BASIC$STARLET"
%INCLUDE "$SMGMSG" %FROM %LIBRARY "SYS$LIBRARY:BASIC$STARLET"

EXTERNAL INTEGER GET_MSG
EXTERNAL INTEGER GET_INPUT

!+
!Assign to the local variables the values that were stored from
!the main program using the MAP area.
!-

keybd_id = keyboard_info(0)
keybd_tab_id = keyboard_info(1)
disp_id = keyboard_info(2)
pastebd = keyboard_info(3)

!+
!SMG$ENABLE_UNSOLICITED_INPUT does not read the input, it simply
!signals the specified AST when there is unsolicited input present.
!You must use SMG$READ_COMPOSED_LINE to actually read the input.
!
!At this time, we check to see if the unsolicited input was a Ctrl/Z.
!If so, we skip over the program lines that spawn the subprocess and
!get ready to exit the program.
!-

```

SMG\$ Routines

SMG\$DISABLE_BROADCAST_TRAPPING

```
status2 = SMG$READ_COMPOSED_LINE (keybd_id, keybd_tab_id, msg2,, &
    msg2_len, disp_id)
IF (status2 = SMG$_EOF) THEN
    GOTO Control_Z
END IF

IF (status2 AND 1%) = 0% THEN
    CALL LIB$STOP (status2 BY VALUE)
END IF

!+
!In order to spawn a subprocess, we must first disable
!unsolicited input trapping and broadcast trapping.
!-

status2 = SMG$DISABLE_UN SOLICITED_INPUT (pastebd)
IF (status2 AND 1%) = 0% THEN
    CALL LIB$STOP (status2 BY VALUE)
END IF

status2 = SMG$DISABLE_BROADCAST_TRAPPING (pastebd)
IF (status2 AND 1%) = 0% THEN
    CALL LIB$STOP (status2 BY VALUE)
END IF

!+
!Save the current screen so that it will not be destroyed when
!the subprocess is executing.
!-

status2 = SMG$SAVE_PHYSICAL_SCREEN (pastebd, new_display)
IF (status2 AND 1%) = 0% THEN
    CALL LIB$STOP (status2 BY VALUE)
END IF

!+
!Call LIB$SPAWN to create the subprocess, and pass the unsolicited
!input as the command line.
!-

spawn_status = LIB$SPAWN (msg2)

!+
!Restore the saved screen image.
!-

status2 = SMG$RESTORE_PHYSICAL_SCREEN (pastebd, new_display)
IF (status2 AND 1%) = 0% THEN
    CALL LIB$STOP (status2 BY VALUE)
END IF

!+
!Reenable broadcast trapping and unsolicited input trapping.
!-

status2 = SMG$ENABLE_UN SOLICITED_INPUT (pastebd, LOC(GET_INPUT))
IF (status2 AND 1%) = 0% THEN
    CALL LIB$STOP (status2 BY VALUE)
END IF

status2 = SMG$SET_BROADCAST_TRAPPING (pastebd, LOC(GET_MSG))
IF (status2 AND 1%) = 0% THEN
    CALL LIB$STOP (status2 BY VALUE)
END IF

!+
!Skip the steps which are performed if the unsolicited input
!was a Ctrl/Z.
!-

GOTO Out_of_sub
```

SMG\$ Routines

SMG\$DISABLE_BROADCAST_TRAPPING

```
Control_Z:
    !+
    !We should disable unsolicited input and broadcast trapping
    !before we leave the program.
    !-

    status2 = SMG$DISABLE_UN SOLICITED_INPUT (pastebd)
    IF (status2 AND 1%) = 0% THEN
        CALL LIB$STOP (status2 BY VALUE)
    END IF
    status2 = SMG$DISABLE_BROADCAST_TRAPPING (pastebd)
    IF (status2 AND 1%) = 0% THEN
        CALL LIB$STOP (status2 BY VALUE)
    END IF

    !+
    !Set the done_flag to 1 so that the main program knows we have
    !to exit.
    !-

    done_flag = 1
Out_of_sub:
    END SUB

30    !+
    !Start of AST routine GET_MSG. This AST is called whenever there
    !is a broadcast message. This routine prints the message in the
    !MESSAGES virtual display.
    !-

    SUB GET_MSG (paste_id, nl_1, nl_2, nl_3, nl_4)
    DECLARE LONG status1, pasteboard, second_disp
    DECLARE WORD msg_len
    DECLARE STRING msg
    DECLARE LONG CONSTANT forward = 1

    MAP (params) LONG disp_info(2), LONG keyboard_info(4)

    %INCLUDE "SMG$ROUTINES" %FROM %LIBRARY "SYS$LIBRARY: BASIC$STARLET"
    %INCLUDE "LIB$ROUTINES" %FROM %LIBRARY "SYS$LIBRARY: BASIC$STARLET"
    %INCLUDE "$SMGDEF" %FROM %LIBRARY "SYS$LIBRARY: BASIC$STARLET"
    %INCLUDE "$SMGMSG" %FROM %LIBRARY "SYS$LIBRARY: BASIC$STARLET"

    !+
    !Assign values to the local variables according to the values stored
    !in the MAP area.
    !-

    pasteboard = disp_info(0)
    second_disp = disp_info(1)

    !+
    !Print the trapped message in the MESSAGES display. If there are no
    !more messages, go back to the infinite loop in the main program.
    !-

    WHILE 1
        status1 = SMG$GET_BROADCAST_MESSAGE (pasteboard, msg, msg_len)
        IF (status1 = SMG$_NO_MORMSG) THEN
            GOTO Exitloop
        END IF
        IF (status1 AND 1%) = 0% THEN
            CALL LIB$STOP (status1 BY VALUE)
        END IF
    END WHILE
```

SMG\$ Routines SMG\$DISABLE_BROADCAST_TRAPPING

```
        status1 = SMG$PUT_LINE (second_disp, msg, &  
forward,, SMG$M_WRAP_CHAR)  
        IF (status1 AND 1%) = 0% THEN  
            CALL LIB$STOP (status1 BY VALUE)  
        END IF  
    NEXT  
Exitloop:  
    END SUB
```

To run the example program, use the following commands.

```
$ BASIC TRAPPING  
$ LINK TRAPPING  
$ RUN TRAPPING
```

The output for this program is shown in the following figures. In Figure SMG-14, the program is waiting for either unsolicited input or broadcast messages.

Figure SMG-14 Output Generated Before Any Input or Messages Are Trapped

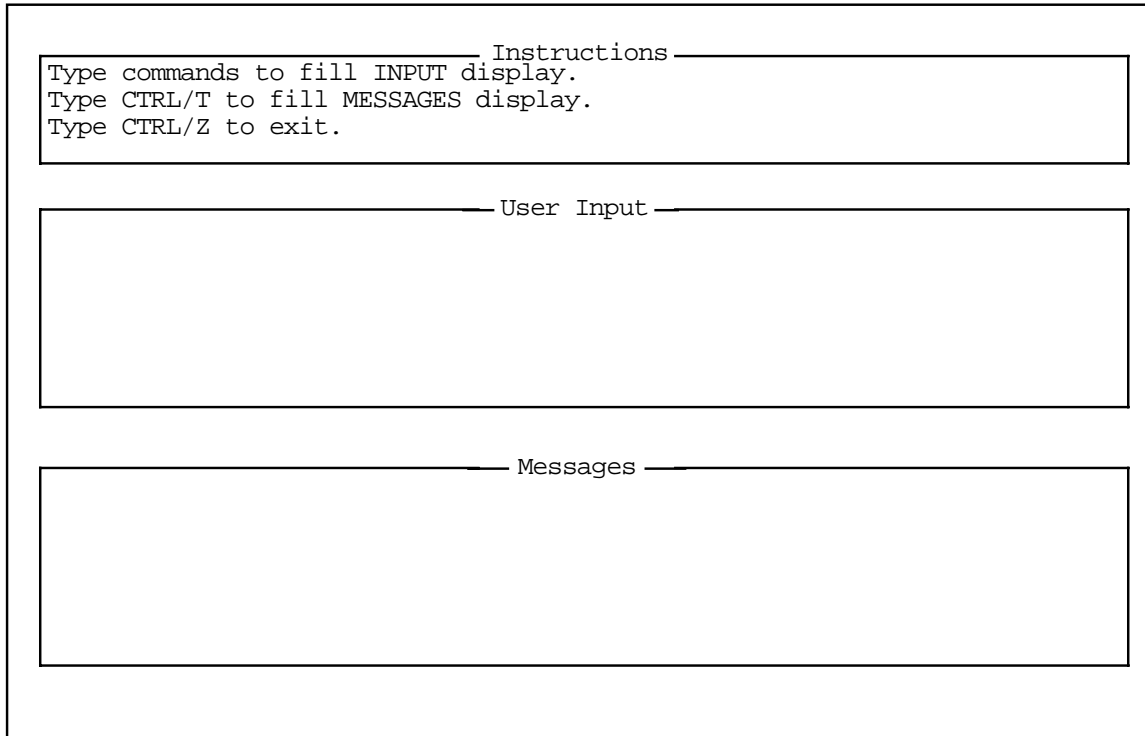

ZK-4805-GE

SMG\$ Routines SMG\$DISABLE_BROADCAST_TRAPPING

The output generated after the user presses Ctrl/T is shown in Figure SMG-15.

Figure SMG-15 Output Generated After a Broadcast Message Is Trapped

```
----- Instructions -----  
Type commands to fill INPUT display.  
Type CTRL/T to fill MESSAGES display.  
Type CTRL/Z to exit.  
  
----- User Input -----  
  
  
  
  
  
  
  
  
  
----- Messages -----  
FUTBAL::COLLINS_1 08:26:43 SAVE CPU=00:00:02.87 PF=401 IO=287 MEM=313
```

ZK-4806-GE

If the user types a command, that command is displayed in the INPUT display, and a subprocess is spawned. The output generated after the user types the MAIL command is shown in Figure SMG-16.

SMG\$ Routines
SMG\$DISABLE_BROADCAST_TRAPPING

Figure SMG-16 Output Generated After a Call to LIB\$SPAWN

```
You have 3 new messages.  
MAIL>
```

ZK-4807-GE

Once the subprocess completes execution, control is returned to the main process. At this point, the screen is repainted and the program continues to wait for broadcast messages or unsolicited input. The user must press Ctrl/Z to exit the program.

SMG\$ Routines

SMG\$DISABLE_UNSOLICITED_INPUT

SMG\$DISABLE_UNSOLICITED_INPUT

Disable Unsolicited Input

The Disable Unsolicited Input routine disables the trapping of unsolicited input.

Format

SMG\$DISABLE_UNSOLICITED_INPUT pasteboard-id

Returns

OpenVMS usage: cond_value
type: longword (unsigned)
access: write only
mechanism: by value

Argument

pasteboard-id
OpenVMS usage: identifier
type: longword (unsigned)
access: read only
mechanism: by reference

Specifies the keyboard (associated with the specified pasteboard) for which unsolicited input is being disabled. The **pasteboard-id** argument is the address of an unsigned longword that contains the pasteboard identifier.

The pasteboard identifier is returned by SMG\$CREATE_PASTEBOARD.

Description

SMG\$DISABLE_UNSOLICITED_INPUT disables unsolicited input ASTs for the specified pasteboard. SMG\$DISABLE_UNSOLICITED_INPUT deassigns the mailbox set with SMG\$ENABLE_UNSOLICITED_INPUT, resets the terminal characteristics and, therefore, allows the user to call LIB\$SPAWN. This routine must be used to disable any unsolicited input trapping enabled with the SMG\$ENABLE_UNSOLICITED_INPUT routine.

Note that if both unsolicited input trapping and the trapping of broadcast messages are enabled, then both SMG\$DISABLE_UNSOLICITED_INPUT and SMG\$DISABLE_BROADCAST_TRAPPING must be invoked in order to deassign the mailbox.

Condition Values Returned

| | |
|-----------------|--------------------------------|
| SS\$NORMAL | Normal successful completion. |
| SMG\$_INVPAS_ID | Invalid pasteboard-id . |
| SMG\$_WRONUMARG | Wrong number of arguments. |

Any condition values returned by \$QIOW.

Example

For an example of using SMG\$DISABLE_UNSOLICITED_INPUT, see the example for the SMG\$DISABLE_BROADCAST_TRAPPING routine.

SMG\$DRAW_CHAR

Draw a Character in a Virtual Display

The Draw a Character in a Virtual Display routine draws a character at the specified position in a virtual display.

Format

```
SMG$DRAW_CHAR display-id ,flags [,row] [,column] [,rendition-set]
               [,rendition-complement]
```

Returns

OpenVMS usage: cond_value
type: longword (unsigned)
access: write only
mechanism: by value

Arguments

display-id

OpenVMS usage: identifier
type: longword (unsigned)
access: read only
mechanism: by reference

Identifier of the virtual display. The **display-id** argument is the address of an unsigned longword containing this identifier.

flags

OpenVMS usage: mask_longword
type: longword (unsigned)
access: read only
mechanism: by reference

Optional bit mask indicating the character to be drawn. The **flags** argument is the address of an unsigned longword that contains the flag. The **flags** argument accepts the following character values:

- SMG\$M_UP
- SMG\$M_DOWN
- SMG\$M_LEFT
- SMG\$M_RIGHT

Note that you may perform a logical OR operation to draw T characters, corner characters, cross characters, and so forth. A value of 0 draws a diamond character.

row

OpenVMS usage: longword_signed
type: longword (signed)
access: read only
mechanism: by reference

Optional row number specifying the row position at which the specified character is drawn. The **row** argument is the address of a signed longword containing the row number. If **row** is omitted, the character is drawn at the row position of the current virtual cursor.

column

OpenVMS usage: longword_signed
type: longword (signed)
access: read only
mechanism: by reference

Optional column number specifying the column position at which the specified character is drawn. The **column** argument is the address of a signed longword containing the column number. If **column** is omitted, the character is drawn at the column position of the current virtual cursor.

rendition-set

OpenVMS usage: mask_longword
type: longword (unsigned)
access: read only
mechanism: by reference

Attribute specifier. The optional **rendition-set** argument is the address of a longword bit mask in which each attribute set causes the corresponding attribute to be set in the display. The following attributes can be specified using the **rendition-set** argument:

| | |
|--|---|
| SMG\$M_BLINK | Displays blinking characters. |
| SMG\$M_BOLD | Displays characters in higher-than-normal intensity. |
| SMG\$M_REVERSE | Displays characters in reverse video; that is, using the opposite of the default rendition of the virtual display. |
| SMG\$M_UNDERLINE | Displays underlined characters. |
| SMG\$M_INVISIBLE | Specifies invisible characters; that is, the characters exist in the virtual display but do not appear on the pasteboard. |
| SMG\$M_USER1 through SMG\$M_ USER8 | Displays user-defined attributes. |

The **display-id** argument must be specified when you use the **rendition-set** argument.

rendition-complement

OpenVMS usage: mask_longword
type: longword (unsigned)
access: read only
mechanism: by reference

Attribute complement specifier. The optional **rendition-complement** argument is the address of a longword bit mask in which each attribute set causes the corresponding attribute to be complemented in the display. All of the attributes that can be specified with the **rendition-set** argument can be complemented with the **rendition-complement** argument. The **display-id** argument must be specified when you use the **rendition-complement** argument.

SMG\$ Routines

SMG\$DRAW_CHAR

The optional arguments **rendition-set** and **rendition-complement** let the user control the attributes of the virtual display. The **rendition-set** argument sets certain virtual display attributes, while **rendition-complement** complements these attributes. If the same bit is specified in both the **rendition-set** and **rendition-complement** parameters, **rendition-set** is evaluated first, followed by **rendition-complement**. By using these two parameters together, the user can control each virtual display attribute in a single procedure call. On a single-attribute basis, the user can cause the following transformations:

| Set | Complement | Action |
|-----|------------|--|
| 0 | 0 | Attribute set to default |
| 1 | 0 | Attribute on |
| 0 | 1 | Attribute set to complement of default setting |
| 1 | 1 | Attribute off |

Description

SMG\$DRAW_CHAR draws a designated character at the specified position in the specified virtual display. Note that this routine does not change the position of the virtual cursor. The characters drawn depend on the type of terminal. For example, SMG\$ uses the terminal's line-drawing character set if possible. If that is not available, SMG\$ uses the plus sign (+), minus sign (-), and vertical bar (|) to draw a line.

Condition Values Returned

| | |
|----------------|-------------------------------|
| SS\$NORMAL | Normal successful completion. |
| SMG\$INVCOL | Invalid column number. |
| SMG\$INVROW | Invalid row number. |
| SMG\$WRONUMARG | Wrong number of arguments. |

Example

```
C+
C This Fortran example demonstrates the use of
C SMG$DRAW_CHAR to use the terminal line drawing
C characters.
C-
  IMPLICIT INTEGER (A-Z)
  INCLUDE '($SMGDEF)'

  s = SMG$CREATE_PASTEBOARD(p_id)
  IF (.NOT. s) CALL LIB$SIGNAL(%VAL(s))
  s = SMG$CREATE_VIRTUAL_DISPLAY(17,7,d_id,SMG$M_BORDER)
  IF (.NOT. s) CALL LIB$SIGNAL(%VAL(s))
  s = SMG$PASTE_VIRTUAL_DISPLAY(d_id,p_id,4,30)
  IF (.NOT. s) CALL LIB$SIGNAL(%VAL(s))
  s = SMG$SET_CURSOR_REL(d_id,1,3)
  IF (.NOT. s) CALL LIB$SIGNAL(%VAL(s))
```

SMG\$ Routines SMG\$DRAW_CHAR

```
s = SMG$DRAW_CHAR(d_id,SMG$M_UP,1,4,SMG$M_BOLD)
IF (.NOT. s) CALL LIB$SIGNAL(%VAL(s))
s = SMG$DRAW_CHAR(d_id,SMG$M_DOWN,2,4,0,SMG$M_REVERSE)
IF (.NOT. s) CALL LIB$SIGNAL(%VAL(s))
s = SMG$DRAW_CHAR(d_id,SMG$M_LEFT,3,4,SMG$M_BLINK)
IF (.NOT. s) CALL LIB$SIGNAL(%VAL(s))
s = SMG$DRAW_CHAR(d_id,SMG$M_RIGHT,4,4,0,0)
IF (.NOT. s) CALL LIB$SIGNAL(%VAL(s))
s = SMG$DRAW_CHAR(d_id,SMG$M_UP + SMG$M_DOWN,5)
IF (.NOT. s) CALL LIB$SIGNAL(%VAL(s))
s = SMG$DRAW_CHAR(d_id,SMG$M_UP + SMG$M_LEFT,6)
IF (.NOT. s) CALL LIB$SIGNAL(%VAL(s))
s = SMG$DRAW_CHAR(d_id,SMG$M_UP + SMG$M_RIGHT,7)
IF (.NOT. s) CALL LIB$SIGNAL(%VAL(s))
s = SMG$DRAW_CHAR(d_id,SMG$M_DOWN + SMG$M_LEFT,8)
IF (.NOT. s) CALL LIB$SIGNAL(%VAL(s))
s = SMG$DRAW_CHAR(d_id,SMG$M_DOWN + SMG$M_RIGHT,9)
IF (.NOT. s) CALL LIB$SIGNAL(%VAL(s))
s = SMG$DRAW_CHAR(d_id,SMG$M_LEFT + SMG$M_RIGHT,10)
IF (.NOT. s) CALL LIB$SIGNAL(%VAL(s))
s = SMG$DRAW_CHAR(d_id,SMG$M_UP + SMG$M_DOWN + SMG$M_LEFT,11)
IF (.NOT. s) CALL LIB$SIGNAL(%VAL(s))
s = SMG$DRAW_CHAR(d_id,SMG$M_UP + SMG$M_DOWN + SMG$M_RIGHT,12)
IF (.NOT. s) CALL LIB$SIGNAL(%VAL(s))
s = SMG$DRAW_CHAR(d_id,SMG$M_DOWN + SMG$M_LEFT + SMG$M_RIGHT,13)
IF (.NOT. s) CALL LIB$SIGNAL(%VAL(s))
s = SMG$DRAW_CHAR(d_id,SMG$M_UP + SMG$M_LEFT + SMG$M_RIGHT,14)
IF (.NOT. s) CALL LIB$SIGNAL(%VAL(s))
s = SMG$DRAW_CHAR(d_id,SMG$M_UP + SMG$M_DOWN + SMG$M_RIGHT +
1          SMG$M_LEFT, 15)
IF (.NOT. s) CALL LIB$SIGNAL(%VAL(s))
s = SMG$DRAW_CHAR(d_id,0,16)
IF (.NOT. s) CALL LIB$SIGNAL(%VAL(s))

END
```

This example generates line-drawing characters in a single column.

SMG\$DRAW_LINE

Draw a Line

The Draw a Line routine draws a horizontal or vertical line.

Format

SMG\$DRAW_LINE display-id ,start-row ,start-column ,end-row ,end-column
[,rendition-set] [,rendition-complement]

Returns

OpenVMS usage: cond_value
type: longword (unsigned)
access: write only
mechanism: by value

Arguments

display-id

OpenVMS usage: identifier
type: longword (unsigned)
access: read only
mechanism: by reference

Specifies the virtual display on which the line is to be drawn. The **display-id** argument is the address of an unsigned longword that contains the display identifier.

The display identifier is returned by SMG\$CREATE_VIRTUAL_DISPLAY.

start-row

OpenVMS usage: longword_signed
type: longword (signed)
access: read only
mechanism: by reference

Specifies the row at which to begin drawing the line. The **start-row** argument is the address of a signed longword that contains the row number at which to begin drawing the line.

start-column

OpenVMS usage: longword_signed
type: longword (signed)
access: read only
mechanism: by reference

Specifies the column at which to begin drawing the line. The **start-column** argument is the address of a signed longword that contains the column number at which to begin drawing the line.

end-row

OpenVMS usage: longword_signed
type: longword (signed)
access: read only
mechanism: by reference

Specifies the row at which the drawn line ends. The **end-row** argument is the address of a signed longword that contains the row number at which the drawn line ends.

end-column

OpenVMS usage: longword_signed
type: longword (signed)
access: read only
mechanism: by reference

Specifies the column at which the drawn line ends. The **end-column** argument is the address of a signed longword that contains the column number at which the drawn line ends.

rendition-set

OpenVMS usage: mask_longword
type: longword (unsigned)
access: read only
mechanism: by reference

Attribute specifier. The optional **rendition-set** argument is the address of a longword bit mask in which each attribute set causes the corresponding attribute to be set in the display. The following attributes can be specified using the **rendition-set** argument:

| | |
|---|---|
| SMG\$M_BLINK | Displays blinking characters. |
| SMG\$M_BOLD | Displays characters in higher-than-normal intensity. |
| SMG\$M_REVERSE | Displays characters in reverse video; that is, using the opposite of the default rendition of the virtual display. |
| SMG\$M_UNDERLINE | Displays underlined characters. |
| SMG\$M_INVISIBLE | Specifies invisible characters; that is, the characters exist in the virtual display but do not appear on the pasteboard. |
| SMG\$M_USER1 through SMG\$M_USER8 | Displays user-defined attributes. |

The **display-id** argument must be specified when you use the **rendition-set** argument.

rendition-complement

OpenVMS usage: mask_longword
type: longword (unsigned)
access: read only
mechanism: by reference

Attribute complement specifier. The optional **rendition-complement** argument is the address of a longword bit mask in which each attribute set causes the corresponding attribute to be complemented in the display. All of the attributes that can be specified with the **rendition-set** argument can be complemented with the **rendition-complement** argument. The **display-id** argument must be specified when you use the **rendition-complement** argument.

SMG\$ Routines

SMG\$DRAW_LINE

The optional arguments **rendition-set** and **rendition-complement** let the user control the attributes of the virtual display. The **rendition-set** argument sets certain virtual display attributes, while **rendition-complement** complements these attributes. If the same bit is specified in both the **rendition-set** and **rendition-complement** parameters, **rendition-set** is evaluated first, followed by **rendition-complement**. By using these two parameters together, the user can control each virtual display attribute in a single procedure call. On a single-attribute basis, the user can cause the following transformations:

| Set | Complement | Action |
|-----|------------|--|
| 0 | 0 | Attribute set to default |
| 1 | 0 | Attribute on |
| 0 | 1 | Attribute set to complement of default setting |
| 1 | 1 | Attribute off |

Description

SMG\$DRAW_LINE draws a line from a specified starting row and column to a specified ending row and column. Note that this routine does not change the virtual cursor position. You can draw only horizontal or vertical lines. The characters used to draw the line depend on the type of terminal. If possible, SMG\$ uses the terminal's line-drawing character set. If that is not available, SMG\$ uses the plus sign (+), minus sign (-), and vertical bar (|) to draw the line.

Condition Values Returned

| | |
|-----------------|---|
| SS\$NORMAL | Normal successful completion. |
| SMG\$_DIALINNOT | Diagonal line not allowed. |
| SMG\$_INVCOL | Invalid column number. The specified column is outside the virtual display. |
| SMG\$_INVDIS_ID | Invalid display-id . |
| SMG\$_INVROW | Invalid row number. The specified row is outside the virtual display |
| SMG\$_WRONUMARG | Wrong number of arguments. |

Example

```
C+
C This Fortran example program demonstrates the use of SMG$DRAW_LINE.
C-
      INTEGER SMG$CREATE_VIRTUAL_DISPLAY, SMG$CREATE_PASTEBOARD
      INTEGER SMG$PASTE_VIRTUAL_DISPLAY, SMG$DRAW_LINE
      INTEGER DISPLAY1, PASTE1, ROWS, COLUMNS, BORDER, STATUS
C+
C First, create the virtual display using SMG$CREATE_VIRTUAL_DISPLAY.
C To give it a border, set BORDER = 1. No border would be BORDER = 0.
C-
      ROWS = 7
      COLUMNS = 50
      BORDER = 1
```

SMG\$ Routines SMG\$DRAW_LINE

```
      STATUS = SMG$CREATE_VIRTUAL_DISPLAY
1      (ROWS, COLUMNS, DISPLAY1, BORDER)
      IF (.NOT. STATUS) CALL LIB$SIGNAL(%VAL(STATUS))

C+
C Call SMG$CREATE_PASTEBOARD to create the pasteboard.
C-

      STATUS = SMG$CREATE_PASTEBOARD (PASTE1)
      IF (.NOT. STATUS) CALL LIB$SIGNAL(%VAL(STATUS))

C+
C Draw a vertical line using SMG$DRAW_LINE.
C Start at row 2, column 20. End at row 6.
C-

      STATUS = SMG$DRAW_LINE (DISPLAY1, 2, 20, 6, 20)
      IF (.NOT. STATUS) CALL LIB$SIGNAL(%VAL(STATUS))

C+
C Now, use SMG$DRAW_LINE to draw a vertical line.
C Start at row 6, column 40. End at row 2.
C This is similar to the line drawn above, but we are drawing the
C line in the reverse direction.
C-

      STATUS = SMG$DRAW_LINE (DISPLAY1, 6, 40, 2, 40)
      IF (.NOT. STATUS) CALL LIB$SIGNAL(%VAL(STATUS))

C+
C Draw a horizontal line now, again calling SMG$DRAW_LINE.
C Start at row 4, column 8. End at column 50.
C-

      STATUS = SMG$DRAW_LINE (DISPLAY1, 4, 8, 4, 50)
      IF (.NOT. STATUS) CALL LIB$SIGNAL(%VAL(STATUS))

C+
C Paste the virtual display using SMG$PASTE_VIRTUAL_DISPLAY.
C-

      STATUS = SMG$PASTE_VIRTUAL_DISPLAY ( DISPLAY1, PASTE1, 4, 15)
      IF (.NOT. STATUS) CALL LIB$SIGNAL(%VAL(STATUS))

      END
```

The output generated by this Fortran example is shown in Figure SMG-17.

SMG\$ Routines
SMG\$DRAW_LINE

Figure SMG-17 Output Generated by Fortran Program Calling SMG\$DRAW_LINE

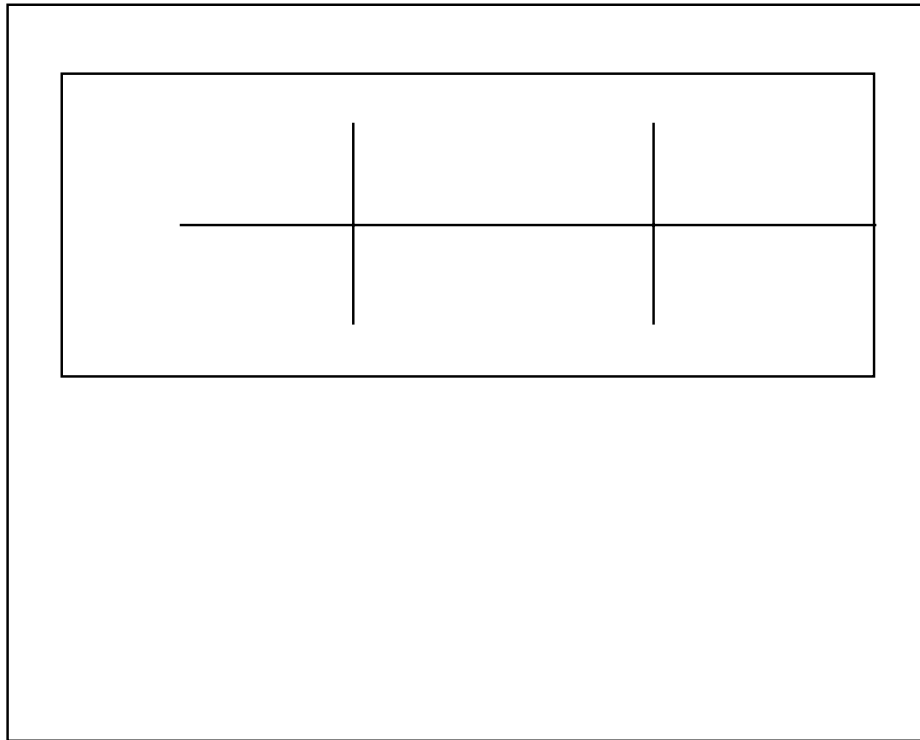

ZK-4110-GE

SMG\$DRAW_RECTANGLE

Draw a Rectangle

The Draw a Rectangle routine draws a rectangle.

Format

SMG\$DRAW_RECTANGLE `display-id ,start-row ,start-column ,end-row ,end-column
[,rendition-set] [,rendition-complement]`

Returns

OpenVMS usage: `cond_value`
type: `longword (unsigned)`
access: `write only`
mechanism: `by value`

Arguments

display-id

OpenVMS usage: `identifier`
type: `longword (unsigned)`
access: `read only`
mechanism: `by reference`

Specifies the virtual display on which the rectangle is to be drawn. The **display-id** argument is the address of an unsigned longword that contains the display identifier.

The display identifier is returned by SMG\$CREATE_VIRTUAL_DISPLAY.

start-row

OpenVMS usage: `longword_signed`
type: `longword (signed)`
access: `read only`
mechanism: `by reference`

Specifies the row number of the top left corner of the rectangle. The **start-row** argument is the address of a signed longword that contains the row number of the top left corner of the rectangle.

start-column

OpenVMS usage: `longword_signed`
type: `longword (signed)`
access: `read only`
mechanism: `by reference`

Specifies the column number of the top left corner of the rectangle. The **start-column** argument is the address of a signed longword that contains the column number of the top left corner of the rectangle.

end-row

OpenVMS usage: `longword_signed`
type: `longword (signed)`
access: `read only`
mechanism: `by reference`

SMG\$ Routines

SMG\$DRAW_RECTANGLE

Specifies the row number of the bottom right corner of the rectangle. The **end-row** argument is the address of a signed longword that contains the row number of the bottom right corner of the rectangle.

end-column

OpenVMS usage: longword_signed
type: longword (signed)
access: read only
mechanism: by reference

Specifies the column number of the bottom right corner of the rectangle. The **end-column** argument is the address of a signed longword that contains the column number of the bottom right corner of the rectangle.

rendition-set

OpenVMS usage: mask_longword
type: longword (unsigned)
access: read only
mechanism: by reference

Attribute specifier. The optional **rendition-set** argument is the address of a longword bit mask in which each attribute set causes the corresponding attribute to be set in the display. The following attributes can be specified using the **rendition-set** argument:

| | |
|---|---|
| SMG\$M_BLINK | Displays blinking characters. |
| SMG\$M_BOLD | Displays characters in higher-than-normal intensity. |
| SMG\$M_REVERSE | Displays characters in reverse video; that is, using the opposite of the default rendition of the virtual display. |
| SMG\$M_UNDERLINE | Displays underlined characters. |
| SMG\$M_INVISIBLE | Specifies invisible characters; that is, the characters exist in the virtual display but do not appear on the pasteboard. |
| SMG\$M_USER1 through SMG\$M_USER8 | Displays user-defined attributes. |

The **display-id** argument must be specified when you use the **rendition-set** argument.

rendition-complement

OpenVMS usage: mask_longword
type: longword (unsigned)
access: read only
mechanism: by reference

Attribute complement specifier. The optional **rendition-complement** argument is the address of a longword bit mask in which each attribute set causes the corresponding attribute to be complemented in the display. All of the attributes that can be specified with the **rendition-set** argument can be complemented with the **rendition-complement** argument. The **display-id** argument must be specified when you use the **rendition-complement** argument.

The optional arguments **rendition-set** and **rendition-complement** let the user control the attributes of the virtual display. The **rendition-set** argument sets certain virtual display attributes, while **rendition-complement** complements these attributes. If the same bit is specified in both the **rendition-set** and **rendition-complement** parameters, **rendition-set** is evaluated first, followed by **rendition-complement**. By using these two parameters together, the user can control each virtual display attribute in a single procedure call. On a single-attribute basis, the user can cause the following transformations:

| Set | Complement | Action |
|-----|------------|--|
| 0 | 0 | Attribute set to default |
| 1 | 0 | Attribute on |
| 0 | 1 | Attribute set to complement of default setting |
| 1 | 1 | Attribute off |

Description

SMG\$DRAW_RECTANGLE draws a rectangle in a virtual display, given the position of the upper left corner and the lower right corner. Note that this routine does not change the virtual cursor position. The characters used to draw the lines making up the rectangle depend on the type of terminal. If possible, SMG\$ uses the terminal's line-drawing character set. If that is not available, SMG\$ uses the plus sign (+), minus sign (-), and vertical bar (|) to draw the lines.

Condition Values Returned

| | |
|----------------|---|
| SS\$NORMAL | Normal successful completion. |
| SMG\$INVCOL | Invalid column number. The specified column is outside the virtual display. |
| SMG\$INVDIS_ID | Invalid display-id . |
| SMG\$INVROW | Invalid row number. The specified row is outside the virtual display. |
| SMG\$WRONUMARG | Wrong number of arguments. |

Example

```
C+
C This Fortran example program demonstrates the use of
C SMG$DRAW_RECTANGLE.
C
C This routine creates a virtual display and uses SMG$DRAW_RECTANGLE
C to draw a rectangle inside the bordered virtual display.
C-

C+
C Include the SMG definitions. In particular, we want SMG$M_BORDER.
C-

      INCLUDE '($SMGDEF)'
      INTEGER SMG$CREATE_VIRTUAL_DISPLAY, SMG$CREATE_PASTEBOARD
      INTEGER SMG$PASTE_VIRTUAL_DISPLAY, SMG$DRAW_RECTANGLE
      INTEGER DISPLAY1, PASTE1, ROWS, COLUMNS, STATUS
```

SMG\$ Routines

SMG\$DRAW_RECTANGLE

```
C+
C Create a virtual display with a border by calling
C SMG$CREATE_VIRTUAL_DISPLAY.
C-

      ROWS = 7
      COLUMNS = 50

      STATUS = SMG$CREATE_VIRTUAL_DISPLAY
1      (ROWS, COLUMNS, DISPLAY1, SMG$M_BORDER)
      IF (.NOT. STATUS) CALL LIB$SIGNAL(%VAL(STATUS))

C+
C Use SMG$CREATE_PASTEBOARD to create the pasteboard.
C-

      STATUS = SMG$CREATE_PASTEBOARD (PASTE1)
      IF (.NOT. STATUS) CALL LIB$SIGNAL(%VAL(STATUS))

C+
C Using SMG$DRAW_RECTANGLE, draw a rectangle inside the bordered region.
C-

      STATUS = SMG$DRAW_RECTANGLE (DISPLAY1, 2, 10, 6, 20)
      IF (.NOT. STATUS) CALL LIB$SIGNAL(%VAL(STATUS))

C+
C Paste the virtual display by calling SMG$PASTE_VIRTUAL_DISPLAY.
C-

      STATUS = SMG$PASTE_VIRTUAL_DISPLAY ( DISPLAY1, PASTE1, 4, 15)
      IF (.NOT. STATUS) CALL LIB$SIGNAL(%VAL(STATUS))

      END
```

The output generated by this Fortran example is shown in Figure SMG-18.

Figure SMG-18 Output Generated by Fortran Program Calling SMG\$DRAW_RECTANGLE

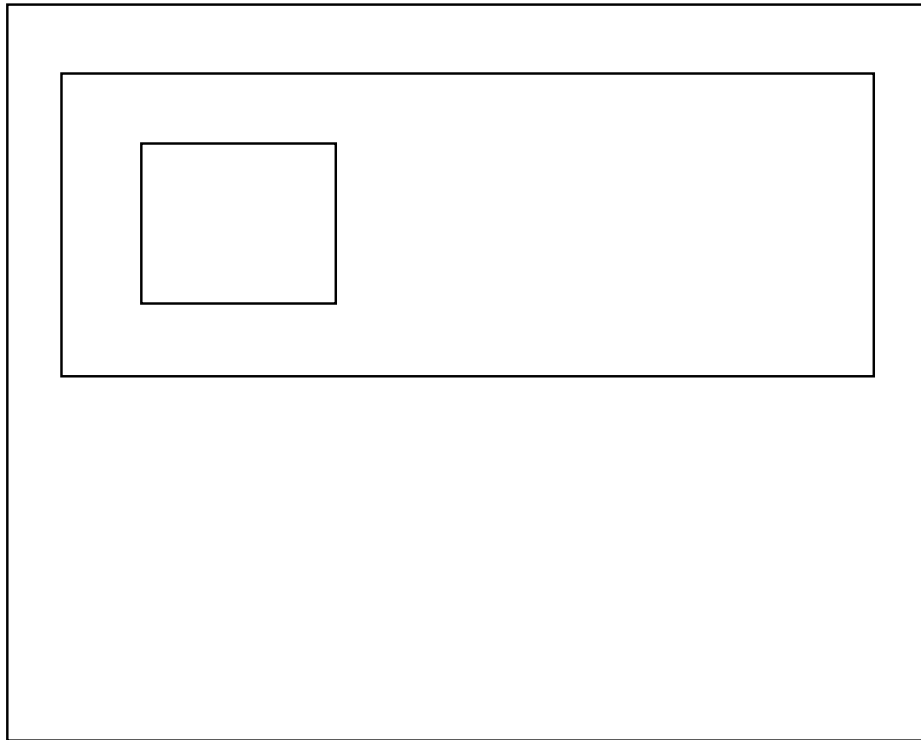

ZK-4111-GE

SMG\$ Routines

SMG\$ENABLE_UNSOLICITED_INPUT

SMG\$ENABLE_UNSOLICITED_INPUT

Enable Unsolicited Input

The Enable Unsolicited Input routine detects unsolicited input and calls an AST routine in response.

Format

SMG\$ENABLE_UNSOLICITED_INPUT pasteboard-id ,AST-routine [,AST-argument]

Returns

OpenVMS usage: cond_value
type: longword (unsigned)
access: write only
mechanism: by value

Arguments

pasteboard-id

OpenVMS usage: identifier
type: longword (unsigned)
access: read only
mechanism: by reference

Specifies the pasteboard for which unsolicited input is being enabled. The **pasteboard-id** argument is the address of an unsigned longword that contains the pasteboard identifier.

The pasteboard identifier is returned by SMG\$CREATE_VIRTUAL_PASTEBOARD.

AST-routine

OpenVMS usage: ast_procedure
type: procedure value
access: read only
mechanism: by value

AST routine to be called upon receipt of unsolicited input at the terminal. The **AST-routine** argument contains the routine's procedure value. SMG\$ENABLE_UNSOLICITED_INPUT detects the presence of unsolicited input and calls the AST routine with six arguments: the **pasteboard-id**, the **AST-argument**, R0, R1, PC, and PSL (on VAX systems) or PS (on Alpha systems). The AST routine arguments are shown in Figure SMG-19.

Figure SMG–19 AST Routine Arguments

| |
|---------------|
| Pasteboard ID |
| AST Argument |
| R0 |
| R1 |
| PC |
| PSL |

ZK-4802-GE

AST-argument

OpenVMS usage: user_arg
type: longword (unsigned)
access: read only
mechanism: by value

A value to be passed to the AST routine. The **AST-argument** argument contains the value to be passed to the AST routine.

Description

SMG\$ENABLE_UNSOLICITED_INPUT detects the presence of unsolicited input and calls an AST routine in response.

Note that this routine does not read any input characters; it merely calls an AST routine to “notify” the application that it should issue a read operation with SMG\$READ_COMPOSED_LINE, SMG\$READ_KEYSTROKE, SMG\$READ_STRING or SMG\$READ_VERIFY. It is up to you to read the unsolicited input.

SMG\$ENABLE_UNSOLICITED_INPUT establishes a mailbox that receives messages when terminal-related events occur that require the attention of the user image. This mailbox carries status messages, not terminal data, from the driver to the user program. This status message is sent to the mailbox when there is unsolicited data in the type-ahead buffer. In this case, the user process enters into a dialogue with the terminal after an unsolicited data message arrives. Once this dialogue is complete, the Screen Management Facility reenables the unsolicited data message function on the last I/O exchange. Only one message is sent between read operations. (The SYSGEN parameters DEFMBXBUFQUO and DEFMBXMXMSG are used when creating the mailbox.)

Condition Values Returned

| | |
|----------------|--------------------------------|
| SS\$NORMAL | Normal successful completion. |
| SMG\$INVPAS_ID | Invalid pasteboard-id . |
| SMG\$WRONUMARG | Wrong number of arguments. |

Any condition values returned by \$QIOW.

SMG\$ Routines

SMG\$ENABLE_UNSOLICITED_INPUT

Example

For an example using SMG\$ENABLE_UNSOLICITED_INPUT, see the example for the SMG\$DISABLE_BROADCAST_TRAPPING routine.

SMG\$END_DISPLAY_UPDATE

End Display Update

The End Display Update routine ends update batching for a virtual display.

Format

SMG\$END_DISPLAY_UPDATE display-id

Returns

OpenVMS usage: cond_value
type: longword (unsigned)
access: write only
mechanism: by value

Argument

display-id
OpenVMS usage: identifier
type: longword (unsigned)
access: read only
mechanism: by reference

Specifies the virtual display to be affected. The **display-id** argument is the address of an unsigned longword that contains the display identifier.

The display identifier is returned by SMG\$CREATE_VIRTUAL_DISPLAY.

Description

SMG\$END_DISPLAY_UPDATE and SMG\$BEGIN_DISPLAY_UPDATE work together to control the batching of output operations on a given virtual display. Each call to SMG\$BEGIN_DISPLAY_UPDATE increments a batch count. Each call to SMG\$END_DISPLAY_UPDATE decrements this count. When the batch count reaches 0, the virtual display is updated with all operations done under batching, and written to the pasteboard if the virtual display is pasted.

Calling SMG\$END_DISPLAY_UPDATE when the batch count is zero is a valid operation; therefore a success status is returned.

Condition Values Returned

| | |
|----------------|---|
| SS\$NORMAL | Normal successful completion. |
| SMG\$BATSTIPRO | Successful completion. Note that batching is still in progress. |
| SMG\$BATWASOFF | Successful completion. Note that batching was already off. |
| SMG\$INVDIS_ID | Invalid display-id . |
| SMG\$WRONUMARG | Wrong number of arguments. |

SMG\$ Routines

SMG\$END_PASTEBOARD_UPDATE

SMG\$END_PASTEBOARD_UPDATE

End Pasteboard Update

The End Pasteboard Update routine ends update batching for a pasteboard.

Format

SMG\$END_PASTEBOARD_UPDATE pasteboard-id

Returns

OpenVMS usage: cond_value
type: longword (unsigned)
access: write only
mechanism: by value

Argument

pasteboard-id
OpenVMS usage: identifier
type: longword (unsigned)
access: read only
mechanism: by reference

Specifies the pasteboard on which the batch count is to be decremented. The **pasteboard-id** argument is the address of an unsigned longword that contains the pasteboard identifier.

The pasteboard identifier is returned by SMG\$CREATE_PASTEBOARD. If the batch count reaches 0, all buffered output for the specified pasteboard is written out.

Description

SMG\$END_PASTEBOARD_UPDATE and SMG\$BEGIN_PASTEBOARD_UPDATE work together to control the batching of output operations on a given pasteboard. Each call to SMG\$BEGIN_PASTEBOARD_UPDATE increments a batch count. Each call to SMG\$END_PASTEBOARD_UPDATE decrements this count. When the batch count reaches 0, the pasteboard is written to the screen.

Calling SMG\$END_PASTEBOARD_UPDATE when the batch count is 0 is a valid operation; a success status is returned.

Condition Values Returned

| | |
|-----------------|---|
| SS\$_NORMAL | Normal successful completion. |
| SMG\$_BATSTIPRO | Successful completion. Note that batching is still in progress. |
| SMG\$_BATWASOFF | Successful completion. Note that batching was already off. |
| SMG\$_INVDIS_ID | Invalid display-id . |
| SMG\$_WRONUMARG | Wrong number of arguments. |

SMG\$ERASE_CHARS

Erase Characters

The Erase Characters routine erases characters in a virtual display by replacing them with blanks.

Format

SMG\$ERASE_CHARS display-id ,number-of-characters ,start-row ,start-column

Returns

OpenVMS usage: cond_value
type: longword (unsigned)
access: write only
mechanism: by value

Arguments

display-id

OpenVMS usage: identifier
type: longword (unsigned)
access: read only
mechanism: by reference

Specifies the virtual display from which characters will be erased. The **display-id** argument is the address of an unsigned longword that contains the display identifier.

The display identifier is returned by SMG\$CREATE_VIRTUAL_DISPLAY.

number-of-characters

OpenVMS usage: longword_signed
type: longword (signed)
access: read only
mechanism: by reference

Specifies the number of characters to be replaced with blanks. The **number-of-characters** argument is the address of a signed longword that contains the number of characters to be replaced with blanks.

start-row

OpenVMS usage: longword_signed
type: longword (signed)
access: read only
mechanism: by reference

Specifies the row on which the erase operation begins. The **start-row** argument is the address of a signed longword that contains the number of the row at which the erasure is to begin.

start-column

OpenVMS usage: longword_signed
type: longword (signed)
access: read only
mechanism: by reference

SMG\$ Routines

SMG\$ERASE_CHARS

Specifies the column on which the erase operation begins. The **start-column** argument is the address of a signed longword that contains the number of the column at which the erasure is to begin.

Description

SMG\$ERASE_CHARS erases characters in a virtual display by replacing them with blanks. The remaining text in the display is not moved. An erase operation is limited to the specified line. If **number-of-characters** is greater than the number of characters remaining in the line, all characters from the specified starting position to the end of the line are erased. This routine leaves the virtual cursor at the position of the first character erased.

Condition Values Returned

| | |
|----------------|-------------------------------|
| SS\$NORMAL | Normal successful completion. |
| SMG\$INVCOL | Invalid column. |
| SMG\$INVDIS_ID | Invalid display-id . |
| SMG\$INVROW | Invalid row. |
| SMG\$WRONUMARG | Wrong number of arguments. |

Example

```
C+
C This Fortran example demonstrates the use of SMG$ERASE_CHARS.
C
C Include the SMG definitions. In particular, we want SMG$M_BORDER.
C-

      IMPLICIT INTEGER (A-Z)
      INCLUDE '($SMGDEF)'

C+
C Create a virtual display with a border by calling
C SMG$CREATE_VIRTUAL_DISPLAY.
C-

      ROWS = 7
      COLUMNS = 50

      STATUS = SMG$CREATE_VIRTUAL_DISPLAY
1     (ROWS, COLUMNS, DISPLAY1, SMG$M_BORDER)
      IF (.NOT. STATUS) CALL LIB$SIGNAL(%VAL(STATUS))

C+
C Call SMG$CREATE_PASTEBOARD to create the pasteboard.
C-

      STATUS = SMG$CREATE_PASTEBOARD (PASTE1)
      IF (.NOT. STATUS) CALL LIB$SIGNAL(%VAL(STATUS))

C+
C Using SMG$PUT_CHARS, put data in the virtual display.
C-

      STATUS = SMG$PUT_CHARS ( DISPLAY1,
1     ' This virtual display has 7 rows and 50 columns.', 2, 1)
      IF (.NOT. STATUS) CALL LIB$SIGNAL(%VAL(STATUS))

      STATUS = SMG$PUT_CHARS ( DISPLAY1,
1     ' This is a bordered virtual display.', 4, 1)
      IF (.NOT. STATUS) CALL LIB$SIGNAL(%VAL(STATUS))
```

SMG\$ Routines SMG\$ERASE_CHARS

```
STATUS = SMG$PUT_CHARS ( DISPLAY1,  
1 ' SMG$PUT_CHARS puts data in this virtual display.', 6, 1)  
IF (.NOT. STATUS) CALL LIB$SIGNAL(%VAL(STATUS))  
  
C+  
C Call SMG$PASTE_VIRTUAL_DISPLAY to paste the virtual display.  
C-  
  
STATUS = SMG$PASTE_VIRTUAL_DISPLAY ( DISPLAY1, PASTE1, 4, 15)  
IF (.NOT. STATUS) CALL LIB$SIGNAL(%VAL(STATUS))  
  
C+  
C Erase 4 characters on row 4 starting from character (column) 14 by  
C calling SMG$ERASE_CHARS. This will remove the characters "rder"  
C from the word "bordered".  
C-  
  
STATUS = SMG$ERASE_CHARS ( DISPLAY1, 4, 4, 14)  
IF (.NOT. STATUS) CALL LIB$SIGNAL(%VAL(STATUS))  
  
END
```

The initial output generated by this Fortran example program is shown in Figure SMG-20.

Figure SMG-20 Output Before the Call to SMG\$ERASE_CHARS

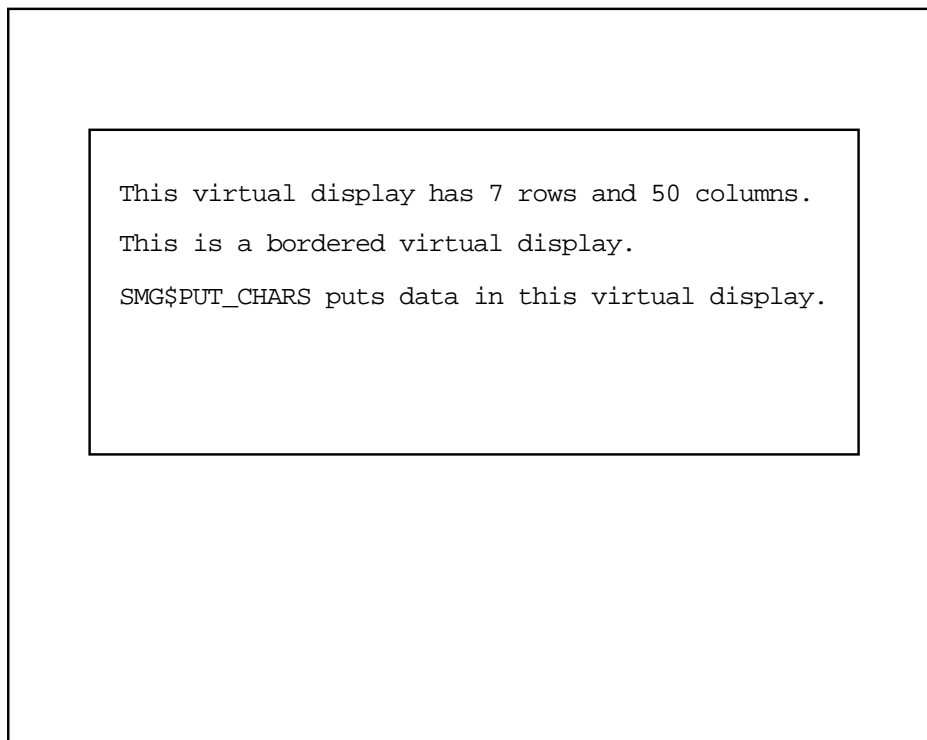

```
This virtual display has 7 rows and 50 columns.  
This is a bordered virtual display.  
SMG$PUT_CHARS puts data in this virtual display.
```

ZK-4105-GE

The output generated after the call to SMG\$ERASE_CHARS is shown in Figure SMG-21.

SMG\$ Routines
SMG\$ERASE_CHARS

Figure SMG-21 Output After the Call to SMG\$ERASE_CHARS

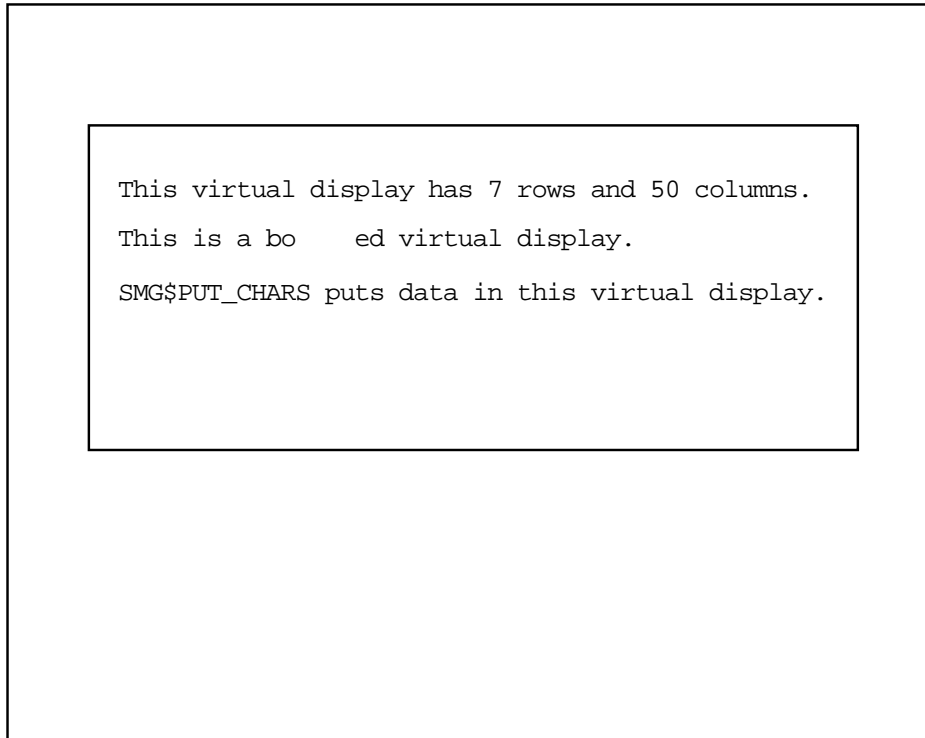

ZK-4113-GE

SMG\$ERASE_COLUMN

Erase Column from Display

The Erase Column from Display routine erases the specified portion of the virtual display from the given position to the end of the column.

Format

SMG\$ERASE_COLUMN display-id [,start-row] [,column-number] [,end-row]

Returns

OpenVMS usage: cond_value
 type: longword (unsigned)
 access: write only
 mechanism: by value

Arguments

display-id

OpenVMS usage: identifier
 type: longword (unsigned)
 access: read only
 mechanism: by reference

Identifier of the virtual display to be affected. The **display-id** argument is the address of an unsigned longword containing this virtual display identifier.

start-row

OpenVMS usage: longword_signed
 type: longword (signed)
 access: read only
 mechanism: by reference

Optional line number at which the erase operation begins. The **start-row** argument is the address of a signed longword that contains the specified line number. If this argument is omitted, the **column-number** argument is ignored and the erase operation begins at the current location of the virtual cursor for that virtual display.

column-number

OpenVMS usage: longword_signed
 type: longword (signed)
 access: read only
 mechanism: by reference

Optional column number at which the erase operation begins. The **column-number** argument is the address of a signed longword that contains the specified column number. If this argument is omitted, the **start-row** argument is ignored and the erase operation begins at the current location of the virtual cursor for that virtual display.

SMG\$ Routines

SMG\$ERASE_COLUMN

end-row

OpenVMS usage: longword_signed
type: longword (signed)
access: read only
mechanism: by reference

Optional row number at which the erase operation ends. The **end-row** argument is the address of a signed longword that contains the specified row number.

Description

SMG\$ERASE_COLUMN lets you erase a column of the virtual display from the specified position to the end of the column. If the position is not specified, the erase operation begins at the current position of the virtual cursor in the specified virtual display. After the erase operation has completed, this routine leaves the virtual cursor at the position of the first character erased.

Condition Values Returned

| | |
|------------|-------------------------------|
| SS\$NORMAL | Normal successful completion. |
|------------|-------------------------------|

SMG\$ERASE_DISPLAY

Erase Virtual Display

The Erase Virtual Display routine erases all or part of a virtual display by replacing text characters with blanks.

Format

```
SMG$ERASE_DISPLAY  display-id [,start-row] [,start-column] [,end-row]
                    [,end-column]
```

Returns

OpenVMS usage: cond_value
 type: longword (unsigned)
 access: write only
 mechanism: by value

Arguments

display-id

OpenVMS usage: identifier
 type: longword (unsigned)
 access: read only
 mechanism: by reference

Specifies the virtual display to be erased. The **display-id** argument is the address of an unsigned longword that contains the display identifier.

The display identifier is returned by SMG\$CREATE_VIRTUAL_DISPLAY.

start-row

OpenVMS usage: longword_signed
 type: longword (signed)
 access: read only
 mechanism: by reference

Specifies the row at which the erase operation begins. The **start-row** argument is the address of a signed longword that contains the number of the row at which the erasure begins.

If the **start-row** argument is not specified, **start-column** is also ignored and the entire virtual display is erased. If you do not specify **start-row** and **start-column**, then **end-row** and **end-column** are ignored and the entire virtual display is erased.

start-column

OpenVMS usage: longword_signed
 type: longword (signed)
 access: read only
 mechanism: by reference

Specifies the column at which the erase operation begins. The **start-column** argument is the address of a signed longword that contains the number of the column at which the erasure begins.

SMG\$ Routines

SMG\$ERASE_DISPLAY

If the **start-column** argument is not specified, **start-row** is also ignored and the entire virtual display is erased. If you do not specify **start-row** and **start-column**, then **end-row** and **end-column** are ignored and the entire virtual display is erased.

end-row

OpenVMS usage: longword_signed
type: longword (signed)
access: read only
mechanism: by reference

Specifies the row at which the erase operation ends; that is, the last row to be erased. The **end-row** argument is the address of a signed longword that contains the number of the last row to be erased.

If the **end-row** argument is not specified, **end-column** is also ignored and all remaining rows in the display are erased.

end-column

OpenVMS usage: longword_signed
type: longword (signed)
access: read only
mechanism: by reference

Specifies the column at which the erase operation ends; that is, the last column to be erased. The **end-column** argument is the address of a signed longword that contains the number of the last column to be erased.

If the **end-column** argument is not specified, **end-row** is also ignored and all remaining columns in the display are erased.

Description

SMG\$ERASE_DISPLAY causes all or part of a virtual display to be erased by replacing text characters with blanks. If omitted, the starting positions default to 1,1. The ending positions default to the last row or column in the display. Thus, to erase the entire virtual display, you need only pass the **display-id**. This routine leaves the virtual cursor at the start of the erased position. If the entire display is erased, the virtual cursor is left at position 1,1.

Condition Values Returned

| | |
|-----------------|---|
| SS\$_NORMAL | Normal successful completion. |
| SMG\$_INVCOL | Invalid column number. The specified column is outside the virtual display. |
| SMG\$_INVDIS_ID | Invalid display-id . |
| SMG\$_INVROW | Invalid row number. The specified row is outside the virtual display. |
| SMG\$_WRONUMARG | Wrong number of arguments. |

Example

```

C+
C This Fortran example program demonstrates the use of SMG$ERASE_DISPLAY.
C-

      IMPLICIT INTEGER (A-Z)

C+
C Call SMG$CREATE_VIRTUAL_DISPLAY to create the virtual
C display. To give it a border, set BORDER = 1.
C No border would be BORDER = 0.
C-

      ROWS = 7
      COLUMNS = 50
      BORDER = 1

      STATUS = SMG$CREATE_VIRTUAL_DISPLAY
1      (ROWS, COLUMNS, DISPLAY1, BORDER)
      IF (.NOT. STATUS) CALL LIB$SIGNAL(%VAL(STATUS))

C+
C Using SMG$CREATE_PASTEBOARD, create the pasteboard.
C-

      STATUS = SMG$CREATE_PASTEBOARD (PASTE1)
      IF (.NOT. STATUS) CALL LIB$SIGNAL(%VAL(STATUS))

C+
C Call SMG$PUT_CHARS to put data in the virtual display.
C-

      STATUS = SMG$PUT_CHARS ( DISPLAY1,
1      ' This virtual display has 7 rows and 50 columns.', 2, 1)
      IF (.NOT. STATUS) CALL LIB$SIGNAL(%VAL(STATUS))

      STATUS = SMG$PUT_CHARS ( DISPLAY1,
1      ' This is a bordered virtual display.', 4, 1)
      IF (.NOT. STATUS) CALL LIB$SIGNAL(%VAL(STATUS))

      STATUS = SMG$PUT_CHARS ( DISPLAY1,
1      ' SMG$PUT_CHARS puts data in this virtual display.', 6, 1)
      IF (.NOT. STATUS) CALL LIB$SIGNAL(%VAL(STATUS))

C+
C Paste the virtual display by calling SMG$PASTE_VIRTUAL_DISPLAY.
C-

      STATUS = SMG$PASTE_VIRTUAL_DISPLAY ( DISPLAY1, PASTE1, 4, 15)
      IF (.NOT. STATUS) CALL LIB$SIGNAL(%VAL(STATUS))

C+
C Call SMG$ERASE_DISPLAY to erase the display from row 2,
C column 6, through row 4, column 28.
C-

      STATUS = SMG$ERASE_DISPLAY ( DISPLAY1, 2, 6, 4, 28)
      IF (.NOT. STATUS) CALL LIB$SIGNAL(%VAL(STATUS))

      END

```

The initial display output by this Fortran program is shown in Figure SMG–22.

SMG\$ Routines
SMG\$ERASE_DISPLAY

Figure SMG-22 Initial Output of Fortran Program Calling SMG\$ERASE_DISPLAY

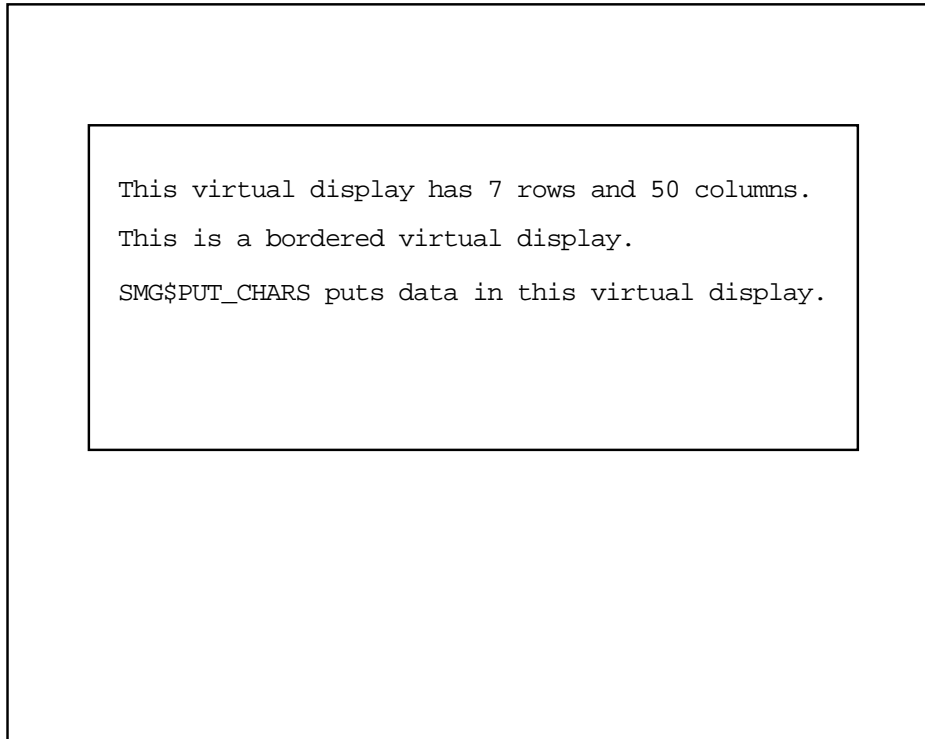

ZK-4105-GE

This output displayed after the call to SMG\$ERASE_DISPLAY is shown in Figure SMG-23.

Figure SMG-23 Output Displayed After the Call to **SMG\$ERASE_DISPLAY**

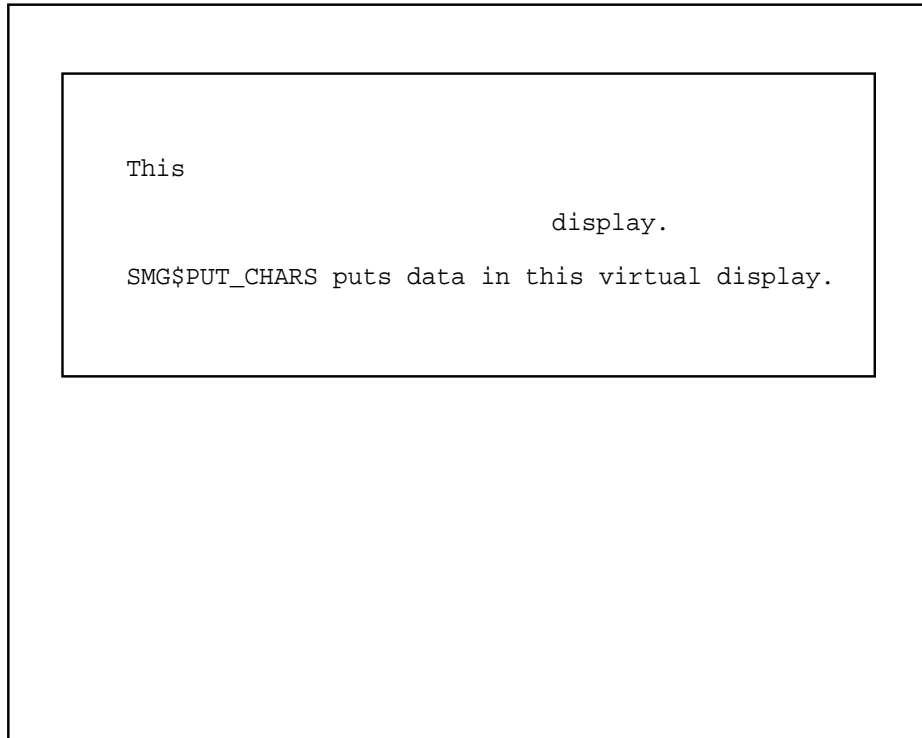

ZK-4115-GE

SMG\$ERASE_LINE

Erase Line

The Erase Line routine erases all or part of a line in a virtual display.

Format

SMG\$ERASE_LINE display-id [,start-row] [,start-column]

Returns

OpenVMS usage: cond_value
type: longword (unsigned)
access: write only
mechanism: by value

Arguments

display-id

OpenVMS usage: identifier
type: longword (unsigned)
access: read only
mechanism: by reference

Specifies the virtual display to be affected. The **display-id** argument is the address of an unsigned longword that contains the display identifier.

The display identifier is returned by SMG\$CREATE_VIRTUAL_DISPLAY.

start-row

OpenVMS usage: longword_signed
type: longword (signed)
access: read only
mechanism: by reference

Specifies the line at which the erase operation starts. The **start-row** argument is the address of a signed longword that contains the number of the row at which the erasure starts. If omitted, **start-column** is also ignored and the current cursor position is used.

start-column

OpenVMS usage: longword_signed
type: longword (signed)
access: read only
mechanism: by reference

Specifies the column at which the erase operation starts. The **start-column** argument is the address of a signed longword that contains the number of the column at which the erasure starts. If omitted, **start-row** is also ignored and the current cursor position is used.

Description

SMG\$ERASE_LINE erases a line from the specified starting position to the end of the line. If you do not specify a starting position, SMG\$ERASE_LINE erases text from the current virtual cursor position to the end of the line. This routine leaves the virtual cursor at the start of the erased portion.

Condition Values Returned

| | |
|------------------|---|
| SS\$ _NORMAL | Normal successful completion. |
| SMG\$ _INVCOL | Invalid column number. The specified column is outside the virtual display. |
| SMG\$ _INVDIS_ID | Invalid display-id . |
| SMG\$ _INVROW | Invalid row number. The specified row is outside the virtual display. |
| SMG\$ _WRONUMARG | Wrong number of arguments. |

Example

```

C+
C This Fortran example program demonstrates the use of
C SMG$ERASE_LINE.
C-

        IMPLICIT INTEGER (A-Z)
        INCLUDE '($SMGDEF)'

C+
C Use SMG$CREATE_VIRTUAL_DISPLAY to create a virtual display
C with a border.
C-

        ROWS = 7
        COLUMNS = 50

        STATUS = SMG$CREATE_VIRTUAL_DISPLAY
1         (ROWS, COLUMNS, DISPLAY1, SMG$_BORDER)
        IF (.NOT. STATUS) CALL LIB$SIGNAL(%VAL(STATUS))

C+
C Call SMG$CREATE_PASTEBOARD to create the pasteboard.
C-

        STATUS = SMG$CREATE_PASTEBOARD (PASTE1)
        IF (.NOT. STATUS) CALL LIB$SIGNAL(%VAL(STATUS))

C+
C Put data in the virtual display by calling SMG$PUT_CHARS.
C-

        STATUS = SMG$PUT_CHARS ( DISPLAY1,
1         ' This virtual display has 7 rows and 50 columns.', 2, 1)
        IF (.NOT. STATUS) CALL LIB$SIGNAL(%VAL(STATUS))

        STATUS = SMG$PUT_CHARS ( DISPLAY1,
1         ' This is a bordered virtual display.', 4, 1)
        IF (.NOT. STATUS) CALL LIB$SIGNAL(%VAL(STATUS))

        STATUS = SMG$PUT_CHARS ( DISPLAY1,
1         ' SMG$PUT_CHARS puts data in this virtual display.', 6, 1)
        IF (.NOT. STATUS) CALL LIB$SIGNAL(%VAL(STATUS))

```

SMG\$ Routines

SMG\$ERASE_LINE

```
C+
C Use SMG$PASTE_VIRTUAL_DISPLAY to paste the virtual display.
C-
      STATUS = SMG$PASTE_VIRTUAL_DISPLAY ( DISPLAY1, PASTE1, 4, 15)
      IF (.NOT. STATUS) CALL LIB$SIGNAL(%VAL(STATUS))

C+
C Call SMG$ERASE_LINE to erase line 2, and then again to
C erase the last 4 words on line 4.
C-
      STATUS = SMG$ERASE_LINE ( DISPLAY1, 2, 1)
      IF (.NOT. STATUS) CALL LIB$SIGNAL(%VAL(STATUS))

      STATUS = SMG$ERASE_LINE ( DISPLAY1, 4, 9)
      IF (.NOT. STATUS) CALL LIB$SIGNAL(%VAL(STATUS))

      END
```

The initial output generated by the Fortran program is shown in Figure SMG-24.

Figure SMG-24 Initial Output Generated by Fortran Program Calling SMG\$ERASE_LINE

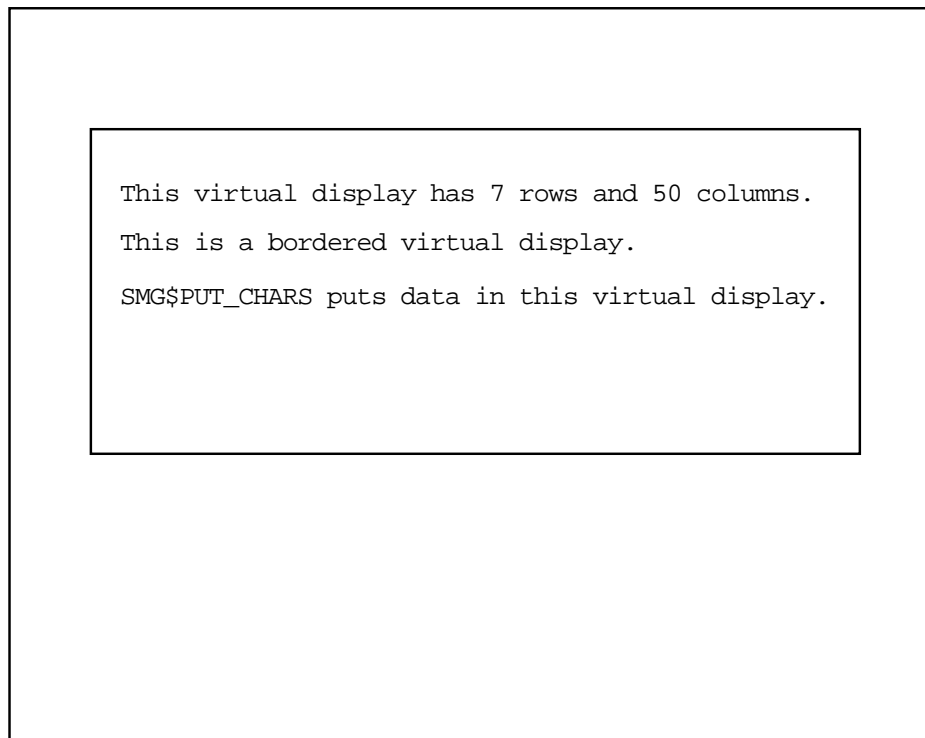

ZK-4108-GE

The output generated after the call to SMG\$ERASE_LINE is shown in Figure SMG-25.

Figure SMG-25 Output Generated After the Call to SMG\$ERASE_LINE

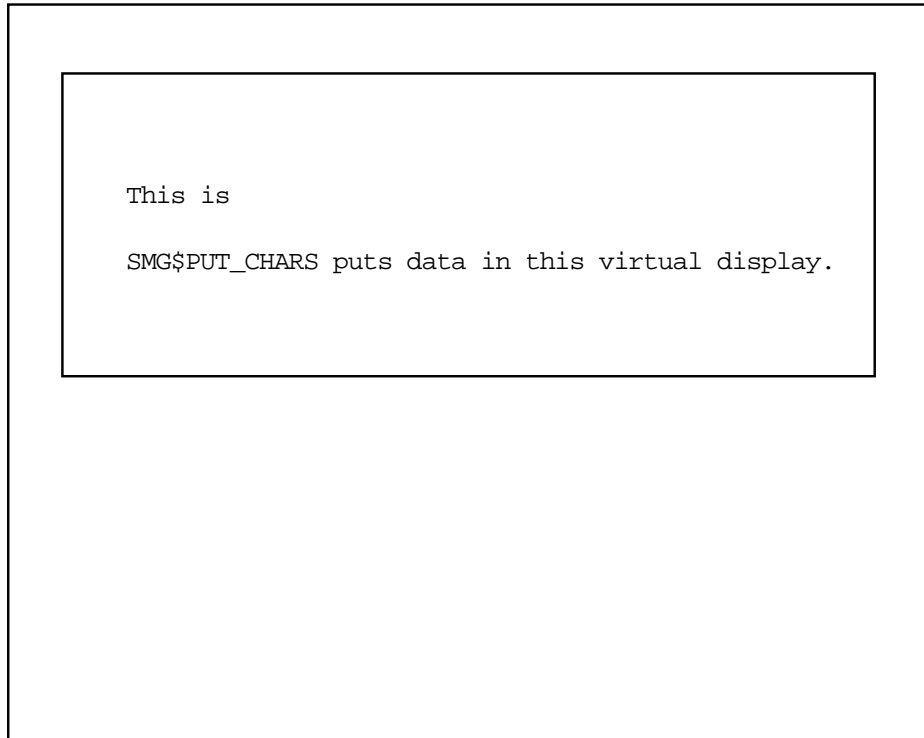

ZK-4117-GE

SMG\$ERASE_PASTEBOARD

Erase Pasteboard

The Erase Pasteboard routine erases the contents of a pasteboard.

Format

SMG\$ERASE_PASTEBOARD pasteboard-id

Returns

OpenVMS usage: cond_value
type: longword (unsigned)
access: write only
mechanism: by value

Argument

pasteboard-id
OpenVMS usage: identifier
type: longword (unsigned)
access: read only
mechanism: by reference

Specifies the pasteboard to be erased. The **pasteboard-id** argument is the address of an unsigned longword that contains the pasteboard identifier.

The pasteboard identifier is returned by SMG\$CREATE_PASTEBOARD.

Description

SMG\$ERASE_PASTEBOARD erases the contents of a specified pasteboard. The physical cursor is left at position 1,1. If there are any virtual displays pasted to the pasteboard, they will be redrawn the next time the Screen Management Facility is used to output to the pasteboard.

Condition Values Returned

| | |
|------------------|--------------------------------|
| SS\$ _NORMAL | Normal successful completion. |
| SS\$ _xxxx | Any status from \$QIOW. |
| SMG\$ _BATWAS_ON | Pasteboard is batched. |
| SMG\$ _INVPAS_ID | Invalid pasteboard-id . |
| SMG\$ _WRONUMARG | Wrong number of arguments. |

Example

```
C+
C This Fortran example program demonstrates the use of
C SMG$ERASE_PASTEBOARD.
C-
      IMPLICIT INTEGER*4 (A-Z)
      CHARACTER*80   OUT_STR,TRIM_STR
      CHARACTER*18   PROMPT          //'Please enter data '/
```

SMG\$ Routines SMG\$ERASE_PASTEBOARD

```

        SMG$M_BOLD = 1
        SMG$M_REVERSE = 2
        SMG$M_BLINK = 4
        SMG$M_UNDERLINE = 8
C+
C Establish the terminal screen as a pasteboard using
C SMG$CREATE_PASTEBOARD.
C-

        STATUS = SMG$CREATE_PASTEBOARD (NEW_PID,,,)
        IF (.NOT. STATUS) CALL LIB$STOP(%VAL(STATUS))
C+
C Establish the terminal keyboard as the virtual keyboard
C by calling SMG$CREATE_VIRTUAL_KEYBOARD.
C-

        STATUS = SMG$CREATE_VIRTUAL_KEYBOARD(KEYBOARD_ID,,,)
        IF (.NOT. STATUS) CALL LIB$STOP(%VAL(STATUS))
C+
C Establish a virtual display region by
C calling SMG$CREATE_VIRTUAL_DISPLAY.
C-

        STATUS = SMG$CREATE_VIRTUAL_DISPLAY (5,80,DISPLAY_ID,,,)
        IF (.NOT. STATUS) CALL LIB$STOP(%VAL(STATUS))
C+
C Paste the virtual display to the screen, starting at
C row 10, column 15. To paste the virtual display, use
C SMG$PASTE_VIRTUAL_DISPLAY.
C-

        STATUS = SMG$PASTE_VIRTUAL_DISPLAY(DISPLAY_ID,NEW_PID,10,15)
        IF (.NOT. STATUS) CALL LIB$STOP(%VAL(STATUS))
C+
C Prompt the user for input, and accept that input using
C SMG$READ_STRING.
C-

        STATUS = SMG$READ_STRING(KEYBOARD_ID,OUT_STR,PROMPT,,,,,,,,)
        IF (.NOT. STATUS) CALL LIB$STOP(%VAL(STATUS))
C+
C Clear the screen using SMG$ERASE_PASTEBOARD.
C-

        STATUS = SMG$ERASE_PASTEBOARD (NEW_PID)
        IF (.NOT. STATUS) CALL LIB$STOP(%VAL(STATUS))
C+
C Trim any trailing blanks from the user input
C by calling STR$TRIM.
C-

        STATUS = STR$TRIM(TRIM_STR,OUT_STR,STR_LEN)
        IF (.NOT. STATUS) CALL LIB$STOP(%VAL(STATUS))
C+
C Display the data input by the user using SMG$PUT_CHARS
C and SMG$PUT_LINE.
C-

        STATUS = SMG$PUT_CHARS(DISPLAY_ID,'You entered: ',,,,,,,,,)
        IF (.NOT. STATUS) CALL LIB$STOP(%VAL(STATUS))
        STATUS = SMG$PUT_LINE(DISPLAY_ID,TRIM_STR(1:STR_LEN),,
1                               SMG$M_REVERSE,0,,)
        IF (.NOT. STATUS) CALL LIB$STOP(%VAL(STATUS))
        END

```

This Fortran program calls Run-Time Library Screen Management routines to format screen output, and to accept and display user input.

SMG\$EXECUTE_COMMAND

Execute Command in a Subprocess

The Execute Command in a Subprocess routine executes the specified command in the subprocess created with the SMG\$CREATE_SUBPROCESS routine.

Format

SMG\$EXECUTE_COMMAND display-id ,command-desc [,flags] [,ret-status]

Returns

OpenVMS usage: cond_value
type: longword (unsigned)
access: write only
mechanism: by value

Arguments

display-id

OpenVMS usage: identifier
type: longword (unsigned)
access: read only
mechanism: by reference

Display identifier of the virtual display with which the subprocess is associated. The **display-id** argument is the address of an unsigned longword containing this identifier.

command-desc

OpenVMS usage: char_string
type: character string
access: read only
mechanism: by descriptor

Command string. The **command-desc** argument is the address of a descriptor pointing to the command string.

flags

OpenVMS usage: mask_longword
type: longword (unsigned)
access: read only
mechanism: by reference

Optional bit mask that specifies optional behavior. The **flags** argument is the address of an unsigned longword that contains the flag. The valid values for **flags** are as follows:

SMG\$M_DATA_FOLLOWS

Input data follows. The next call to SMG\$EXECUTE_COMMAND contains input data for the currently executing command. Do not specify this value if this is the last input data item. If you do specify this value, **ret-status** is not returned.

SMG\$M_SEND_EOF Send end-of-file marker. The end-of-file marker is sent to the subprocess.

ret-status

OpenVMS usage: cond_value
 type: longword (unsigned)
 access: write only
 mechanism: by reference

Optional status of the executed command, provided that the commands are not being buffered. The **ret-status** argument is the address of an unsigned longword containing this status.

Description

SMG\$EXECUTE_COMMAND lets you execute the specified command in the subprocess created with SMG\$CREATE_SUBPROCESS. If commands are being buffered, this routine returns control after the command has been buffered, and the user-specified AST routine is invoked when the command completes. If commands are not being buffered, SMG\$EXECUTE_COMMAND waits until the command has completed execution before returning the status of the command.

When specifying the command string, you must specify a dollar sign (\$) as the first character of any DCL command. Any command string that does not begin with a dollar sign is assumed to be input data for the previous command. SMG\$EXECUTE_COMMAND outputs the commands and their output to the specified virtual display as they are executed. Do not perform I/O to the specified virtual display. Note that the commands SPAWN, GOTO, and LOGOUT are illegal to use as command strings and generate unpredictable results.

Since I/O is performed using mailboxes and not through the terminal driver, command prompts and single-character commands such as Ctrl/C, Ctrl/Y, Ctrl/Z, and so forth have no effect. You should specify SMG\$M_SEND_EOF for the **flags** argument in order to send a Ctrl/Z to the subprocess. For more information on mailboxes, see the mailbox driver section of the *OpenVMS I/O User's Reference Manual*.

Condition Values Returned

| | |
|-----------------|--|
| SS\$_NORMAL | Normal successful completion. |
| SS\$_xxxx | Any status from \$QIO, \$DCLAST, or \$SYNCH. |
| SMG\$_INPTOOLON | Input is longer than 255 characters. |
| SMG\$_INVDIS_ID | Invalid display-id . |
| SMG\$_NOSUBEXI | No subprocess exists. |
| SMG\$_xxxx | Any status from SMG\$PUT_LINE. |
| LIB\$_xxxx | Any status from LIB\$ANALYZE_SDESC. |

SMG\$FIND_CURSOR_DISPLAY

Find Display that Contains the Cursor

The Find Display that Contains the Cursor routine returns the identifier of the most recently pasted virtual display that contains the physical cursor.

Format

```
SMG$FIND_CURSOR_DISPLAY  pasteboard-id ,display-id [,pasteboard-row]  
                        [,pasteboard-column]
```

Returns

OpenVMS usage: cond_value
type: longword (unsigned)
access: write only
mechanism: by value

Arguments

pasteboard-id

OpenVMS usage: identifier
type: longword (unsigned)
access: read only
mechanism: by reference

Specifies the pasteboard in which the physical cursor is to be found. The **pasteboard-id** argument is the address of an unsigned longword that contains the pasteboard identifier.

The pasteboard identifier is returned by SMG\$CREATE_PASTEBOARD.

display-id

OpenVMS usage: identifier
type: longword (unsigned)
access: write only
mechanism: by reference

Receives the identifier of the display in which the physical cursor was found. The **display-id** argument is the address of an unsigned longword into which the display identifier is written.

pasteboard-row

OpenVMS usage: longword_signed
type: longword (signed)
access: read only
mechanism: by reference

The row position at which to begin the search for the physical cursor. The optional **pasteboard-row** argument is the address of a signed longword containing the pasteboard row. You can use **pasteboard-row** instead of the physical cursor row.

pasteboard-column

OpenVMS usage: longword_signed
type: longword (signed)
access: read only
mechanism: by reference

The column position at which to begin the search for the physical cursor. The optional **pasteboard-column** argument is the address of a signed longword containing the pasteboard column. You can use **pasteboard-column** instead of the physical cursor column.

Description

SMG\$FIND_CURSOR_DISPLAY determines which virtual display contains the physical cursor on a specified pasteboard, and returns the virtual display's identifier. SMG\$FIND_CURSOR_DISPLAY returns the **display-id** of the most recently pasted virtual display that contains the physical cursor. If no virtual display contains the physical cursor, this routine returns a zero, which is an invalid display identifier.

Condition Values Returned

| | |
|----------------|--------------------------------|
| SS\$NORMAL | Normal successful completion. |
| SMG\$INVPAS_ID | Invalid pasteboard-id . |
| SMG\$WRONUMARG | Wrong number of arguments. |

SMG\$FLUSH_BUFFER

Flush Buffer

The Flush Buffer routine flushes all buffered output to the terminal.

Format

SMG\$FLUSH_BUFFER pasteboard-id

Returns

OpenVMS usage: cond_value
type: longword (unsigned)
access: write only
mechanism: by value

Argument

pasteboard-id
OpenVMS usage: identifier
type: longword (unsigned)
access: read only
mechanism: by reference

Specifies the pasteboard to be flushed. The **pasteboard-id** argument is the address of an unsigned longword that contains the pasteboard identifier.

The pasteboard identifier is returned by SMG\$CREATE_PASTEBOARD.

Description

SMG\$FLUSH_BUFFER causes all buffered output that is not already output to be sent to the pasteboard immediately. The Screen Management Facility outputs the text when the buffer is full; therefore, this routine is only needed when a partial buffer must be output. The calling program would normally call this routine just before performing some CPU-intensive calculations, or whenever the pasteboard must be up to date.

Condition Values Returned

| | |
|-----------------|--------------------------------|
| SS\$_NORMAL | Normal successful completion. |
| SS\$_xxxx | Any error from \$QIOW. |
| SMG\$_INVPAS_ID | Invalid pasteboard-id . |
| SMG\$_WRONUMARG | Wrong number of arguments. |

SMG\$FLUSH_DISPLAY_UPDATE

Flush Display Update

The Flush Display Update routine flushes any update batching to the screen and leaves the update batching in effect.

Format

SMG\$FLUSH_DISPLAY_UPDATE display-id

Returns

OpenVMS usage: cond_value
type: longword (unsigned)
access: write only
mechanism: by value

Argument

display-id
OpenVMS usage: identifier
type: longword (unsigned)
access: read only
mechanism: by reference

Specifies the virtual display to be affected. The **display-id** argument is the address of an unsigned longword that contains the display identifier.

The display argument is returned by SMG\$CREATE_VIRTUAL_DISPLAY.

Description

SMG\$FLUSH_DISPLAY_UPDATE works with SMG\$END_DISPLAY_UPDATE and SMG\$BEGIN_DISPLAY_UPDATE to control the batching of output operations on a given virtual display. Each call to SMG\$FLUSH_DISPLAY_UPDATE immediately updates the virtual display with all operations previously performed under batching, and written to the pasteboard if the virtual display is pasted.

SMG\$FLUSH_DISPLAY_UPDATE can be used in place of a call to SMG\$END_DISPLAY_UPDATE that is immediately followed by a call to SMG\$BEGIN_DISPLAY_UPDATE, when the batch count is zero, with much better performance than the two calls.

Condition Values Returned

| | |
|-----------------|-------------------------------|
| SS\$NORMAL | Normal successful completion. |
| SMG\$_INVDIS_ID | Invalid display-id . |
| SMG\$_WRONUMARG | Wrong number of arguments. |

SMG\$ Routines

SMG\$GET_BROADCAST_MESSAGE

SMG\$GET_BROADCAST_MESSAGE

Get Broadcast Message

The Get Broadcast Message routine determines whether a message has been broadcast to the pasteboard and returns the message.

Format

```
SMG$GET_BROADCAST_MESSAGE  pasteboard-id [,message] [,message-length]
                             [,message-type]
```

Returns

OpenVMS usage: cond_value
type: longword (unsigned)
access: write only
mechanism: by value

Arguments

pasteboard-id

OpenVMS usage: identifier
type: longword (unsigned)
access: read only
mechanism: by reference

Specifies the pasteboard to be checked for the presence of a broadcast message. The **pasteboard-id** argument is the address of an unsigned longword that contains the pasteboard identifier.

The pasteboard identifier is returned by SMG\$CREATE_PASTEBOARD.

message

OpenVMS usage: char_string
type: character string
access: write only
mechanism: by descriptor

A string that receives the broadcast message, if such a message is available. The **message** argument is the address of a descriptor that points to the string into which the message text is written. If this argument is omitted, the broadcast message is discarded.

message-length

OpenVMS usage: word_unsigned
type: word (unsigned)
access: write only
mechanism: by reference

Receives the actual length of the broadcast message. The **message-length** argument is the address of an unsigned word into which is written the length of the message.

message-type

OpenVMS usage: word_unsigned
type: word (unsigned)
access: write only
mechanism: by reference

Receives the type of broadcast message. The **message-type** argument is the address of an unsigned word into which is written the type of message. Values for **message-type** are defined by the \$MSGDEF library definition. If the value for **message-type** is not MSG\$_TRMBRDCST, the condition value returned is SMG\$_NOBRDMSG.

Description

SMG\$GET_BROADCAST_MESSAGE determines if any broadcast messages have been sent to the specified pasteboard while broadcast trapping was enabled and, if so, returns the message in the **message** argument. You may call this routine repeatedly until all broadcast messages have been returned. If there are no more broadcast messages available, SMG\$GET_BROADCAST_MESSAGE returns the success status SMG\$_NO_MORMSG.

Condition Values Returned

| | |
|-----------------|---|
| SS\$_NORMAL | Normal successful completion. |
| SMG\$_INVPAS_ID | Invalid pasteboard-id . |
| SMG\$_NO_MORMSG | Successful completion. No more messages to be returned. |
| SMG\$_NONBRDMSG | Nonbroadcast message returned. |
| SMG\$_WRONUMARG | Wrong number of arguments. |

Any condition values returned by LIB\$COPY_DXDX.

SMG\$GET_CHAR_AT_PHYSICAL_CURSOR

Return Character at Cursor

The Return Character at Cursor routine returns the character at the current physical cursor position.

Format

SMG\$GET_CHAR_AT_PHYSICAL_CURSOR pasteboard-id ,character-code
[,rendition] [,user-rendition]

Returns

OpenVMS usage: cond_value
type: longword (unsigned)
access: write only
mechanism: by value

Arguments

pasteboard-id

OpenVMS usage: identifier
type: longword (unsigned)
access: read only
mechanism: by reference

Specifies the pasteboard from which to retrieve the character. The **pasteboard-id** argument is the address of an unsigned longword that contains the pasteboard identifier.

The pasteboard identifier is returned by SMG\$CREATE_PASTEBOARD.

character-code

OpenVMS usage: byte_unsigned
type: byte (unsigned)
access: write only
mechanism: by reference

Returned character code. The **character-code** argument is the address of an unsigned byte into which is written the character's ASCII code.

rendition

OpenVMS usage: byte_unsigned
type: byte (unsigned)
access: write only
mechanism: by reference

Receives the rendition code associated with the character code returned by the **character-code** argument. The **rendition** argument is the address of an unsigned byte into which is written the rendition code.

SMG\$ Routines SMG\$GET_CHAR_AT_PHYSICAL_CURSOR

user-rendition

OpenVMS usage: byte_unsigned
type: byte (unsigned)
access: write only
mechanism: by reference

Receives the user rendition code associated with the character code returned by the **character-code** argument. The **user-rendition** argument is the address of an unsigned byte into which is written the user rendition code.

Description

SMG\$GET_CHAR_AT_PHYSICAL_CURSOR returns the character that occupies the screen position corresponding to the current physical cursor position.

Note

If the Screen Management Facility has not written to the screen location occupied by the physical cursor, then the contents of that position are unknown.

If the returned character has an ASCII value less than 32 (decimal), it is not a printable character. Rather, it is an internal terminal-independent code denoting what should be displayed at that position (for example, an element of the line-drawing character set). Do not attempt to use this code for subsequent output operations.

SMG\$GET_CHAR_AT_PHYSICAL_CURSOR may not return valid data if display batching or pasteboard batching is on. This can occur because the cursor position does not reflect any calls to SMG\$SET_PHYSICAL_CURSOR or the SMG\$SET_CURSOR_XXXX routines until batching ends.

Condition Values Returned

| | |
|----------------|--------------------------------|
| SS\$NORMAL | Normal successful completion. |
| SMG\$INVPAS_ID | Invalid pasteboard-id . |
| SMG\$WRONUMARG | Wrong number of arguments. |

SMG\$GET_DISPLAY_ATTR

Get Display Attributes

The Get Display Attributes routine receives the attributes associated with a virtual display.

Format

SMG\$GET_DISPLAY_ATTR display-id [,height] [,width] [,display-attributes]
[,video-attributes] [,character-set] [,flags]

Returns

OpenVMS usage: cond_value
type: longword (unsigned)
access: write only
mechanism: by value

Arguments

display-id

OpenVMS usage: identifier
type: longword (unsigned)
access: read only
mechanism: by reference

Specifies the virtual display for which information is requested. The **display-id** argument is the address of an unsigned longword that contains the display identifier.

The display identifier is returned by SMG\$CREATE_VIRTUAL_DISPLAY.

height

OpenVMS usage: longword_signed
type: longword (signed)
access: write only
mechanism: by reference

Receives the number of rows in the display. The optional **height** argument is the address of a signed longword into which the height is written.

width

OpenVMS usage: longword_signed
type: longword (signed)
access: write only
mechanism: by reference

Receives the number of columns in the display. The optional **width** argument is the address of a signed longword into which is written the number of columns in the display.

display-attributes

OpenVMS usage: mask_longword
type: longword (unsigned)
access: write only
mechanism: by reference

Receives the current default display attributes. The optional **display-attributes** argument is the address of an unsigned longword into which the current display attributes are written.

Valid values for **display-attributes** are as follows:

| | |
|-------------------------|---|
| SMG\$M_BORDER | Specifies a bordered display. If omitted, the display is not bordered. |
| SMG\$M_BLOCK_BORDER | Specifies a block bordered display. If omitted, the display is not bordered. |
| SMG\$M_DISPLAY_CONTROLS | Specifies that control characters such as carriage return and line feed are displayed as graphic characters, if your terminal supports them. |
| SMG\$M_TRUNC_ICON | Specifies that an icon (generally a diamond shape) is displayed where truncation of a line exceeding the width of the virtual display has occurred. |

video-attributes

OpenVMS usage: mask_longword
 type: longword (unsigned)
 access: write only
 mechanism: by reference

Receives the current default video attributes. The optional **video-attributes** argument is the address of an unsigned longword into which the current video attributes are written.

Valid video attributes are as follows:

| | |
|--------------------------------------|---|
| SMG\$M_BLINK | Displays blinking characters. |
| SMG\$M_BOLD | Displays characters in higher-than-normal intensity. |
| SMG\$M_REVERSE | Displays characters in reverse video; that is, using the opposite of the default rendition of the virtual display. |
| SMG\$M_UNDERLINE | Displays underlined characters. |
| SMG\$M_INVISIBLE | Specifies invisible characters; that is, the characters exist in the virtual display but do not appear on the pasteboard. |
| SMG\$M_USER1 through SMG\$M_USER8 | Displays user-defined attributes. |

character-set

OpenVMS usage: longword_unsigned
 type: longword (unsigned)
 access: write only
 mechanism: by reference

Receives the default character set for all text in this virtual display. The optional **character-set** argument is the address of an unsigned longword that specifies the character set. Valid values are SMG\$C_ASCII (the default) and SMG\$C_SPEC_GRAPHICS.

SMG\$ Routines

SMG\$GET_DISPLAY_ATTR

flags

OpenVMS usage: mask_longword
type: longword (unsigned)
access: write only
mechanism: by reference

Optional bit mask specifying attributes of the specified display. The **flags** argument is the address of an unsigned longword containing the flag. Valid values for **flags** are as follows:

| | |
|-------------------|--|
| SMG\$M_SUBPROCESS | Display has a subprocess attached to it. |
| SMG\$M_MENU | Display contains a menu. |
| SMG\$M_VIEWPORT | Display contains a viewport. |

Description

SMG\$GET_DISPLAY_ATTR receives the attributes of a virtual display.

Condition Values Returned

| | |
|----------------|-------------------------------|
| SS\$NORMAL | Normal successful completion. |
| SMG\$INVDIS_ID | Invalid display-id . |
| SMG\$WRONUMARG | Wrong number of arguments. |

SMG\$GET_KEYBOARD_ATTRIBUTES

Get Keyboard Attributes

The Get Keyboard Attributes routine gets information about a virtual keyboard and leaves it in a user-supplied area: the keyboard information table (KIT).

Format

```
SMG$GET_KEYBOARD_ATTRIBUTES keyboard-id ,keyboard-info-table
                             ,keyboard-info-table-size
```

Returns

```
OpenVMS usage: cond_value
type:          longword (unsigned)
access:        write only
mechanism:     by value
```

Arguments

keyboard-id

```
OpenVMS usage: identifier
type:          longword (unsigned)
access:        read only
mechanism:     by reference
```

Keyboard identifier. The **keyboard-id** argument is the address of an unsigned longword containing the identifier of the virtual keyboard from which to read.

Create a virtual keyboard by calling the SMG\$CREATE_VIRTUAL_KEYBOARD routine.

keyboard-info-table

```
OpenVMS usage: unspecified
type:          unspecified
access:        write only
mechanism:     by reference, array reference
```

Receives the keyboard attributes. The **keyboard-info-table** argument is the address of a data block into which the keyboard attributes are written.

The KIT is a byte block whose size and field references are described in \$SMGDEF. It is the caller's responsibility to allocate the correct size block and to pass its address to this routine.

The values in the **keyboard-info-table** can be accessed through the following symbolic names:

| | |
|--------------------|---|
| SMG\$L_DEV_CHAR | Device characteristics (longword) |
| SMG\$L_DEV_DEPEND | Specific characteristics 1 (longword) |
| SMG\$L_DEV_DEPEND2 | Specific characteristics 2 (longword) |
| SMG\$L_DEV_DEPEND3 | Specific characteristics 3 (longword) |
| SMG\$B_DEV_CLASS | Device class (byte) — for example, DCS_TERM |
| SMG\$B_RECALL_NUM | Size of recall buffer (byte)* |

SMG\$ Routines

SMG\$GET_KEYBOARD_ATTRIBUTES

| | |
|---------------------|--|
| SMG\$B_DEVTYPE | Physical device type (byte) — for example, TTS_VT100 |
| SMG\$B_TYPEAHD_CHAR | First character in type-ahead buffer (byte)* |
| SMG\$W_NUM_COLUMNS | Terminal width (word) |
| SMG\$W_TYPEAHD_CNT | Number of characters in type-ahead buffer (word)* |

Items marked with an asterisk (*) will be zero unless the device is a terminal (DEVCLASS = DC\$_TERM).

keyboard-info-table-size

OpenVMS usage: longword_unsigned
type: longword (unsigned)
access: read only
mechanism: by reference

Size of the keyboard information table. The **keyboard-info-table-size** argument is the address of an unsigned longword containing the size of the KIT in bytes.

The size you specify must be exact. You can specify this size with the symbolic constant SMG\$C_KEYBOARD_INFO_BLOCK.

Description

SMG\$GET_KEYBOARD_ATTRIBUTES retrieves information about a virtual keyboard and leaves this information in the KIT.

Condition Values Returned

| | |
|-----------------|-------------------------------|
| SS\$_NORMAL | Normal successful completion. |
| SMG\$_INVARG | KIT is the wrong size. |
| SMG\$_INVKBD_ID | Invalid keyboard-id . |

Example

```
10      !+
        !This VAX BASIC program demonstrates the use of
        !SMG$GET_KEYBOARD_ATTRIBUTES.
        !-

        OPTION TYPE = EXPLICIT
        OPTION CONSTANT TYPE = INTEGER

        %INCLUDE "$SMGDEF" %FROM %LIBRARY "SYS$LIBRARY:BASIC$STARLET"
        %INCLUDE "$SSDEF" %FROM %LIBRARY "SYS$LIBRARY:BASIC$STARLET"

        EXTERNAL LONG FUNCTION LIB$SIGNAL( LONG BY VALUE), &
        SMG$CREATE_VIRTUAL_KEYBOARD( LONG ), &
        SMG$GET_KEYBOARD_ATTRIBUTES( LONG, ANY, LONG )

        DECLARE SMG$ATTRIBUTE_INFO_BLOCK SMG_INFO
        DECLARE LONG S, KEYBOARD_ID

        S = SMG$CREATE_VIRTUAL_KEYBOARD( KEYBOARD_ID )
        IF S <> SS$_NORMAL THEN CALL LIB$SIGNAL( S ) END IF

        S = SMG$GET_KEYBOARD_ATTRIBUTES( KEYBOARD_ID, &
        SMG_INFO, &
        SMG$C_KEYBOARD_INFO_BLOCK )
        IF S <> SS$_NORMAL THEN CALL LIB$SIGNAL( S ) END IF
```

SMG\$ Routines SMG\$GET_KEYBOARD_ATTRIBUTES

```
PRINT SMG_INFO::SMG$L_DEV_CHAR      ! Device characteristics
PRINT SMG_INFO::SMG$L_DEV_DEPEND    ! Specific characteristics (1)
PRINT SMG_INFO::SMG$L_DEV_DEPEND2  ! Specific characteristics (2)
PRINT SMG_INFO::SMG$B_DEV_CLASS     ! Device class ( DC$TERM )
PRINT SMG_INFO::SMG$B_RECALL_NUM    ! Size of SMG recall buffer
PRINT SMG_INFO::SMG$B_DEV_TYPE      ! Device type ( DT$VT100 )
PRINT SMG_INFO::SMG$B_TYPEAHD_CHAR  ! First character in
                                     ! typeahead buffer
PRINT SMG_INFO::SMG$W_NUM_COLUMNS   ! Terminal width
PRINT SMG_INFO::SMG$W_TYPEAHD_CNT   ! Number of characters in
                                     ! typeahead buffer

END
```

SMG\$GET_KEY_DEF

Get Key Definition

The Get Key Definition routine returns the key definition for a specified key.

Format

```
SMG$GET_KEY_DEF  key-table-id ,key-name [,if-state] [,attributes]
                  [,equivalence-string] [,state-string]
```

Returns

OpenVMS usage: cond_value
type: longword (unsigned)
access: write only
mechanism: by value

Arguments

key-table-id

OpenVMS usage: identifier
type: longword (unsigned)
access: read only
mechanism: by reference

Specifies the key table from which you are extracting a definition. The **key-table-id** argument is the address of an unsigned longword that contains the key table identifier.

The key table identifier is returned by SMG\$CREATE_KEY_TABLE.

key-name

OpenVMS usage: char_string
type: character string
access: read only
mechanism: by descriptor

Specifies the name of the key associated with the definition. The **key-name** argument is the address of a descriptor pointing to the key name.

Table 3-1 lists the valid key names.

if-state

OpenVMS usage: char_string
type: character string
access: read only
mechanism: by descriptor

Specifies the current state name in effect after the key is pressed. The **if-state** argument is the address of a descriptor pointing to the state name.

See SMG\$ADD_KEY_DEF for more information.

attributes

OpenVMS usage: mask_longword
type: longword (unsigned)
access: write only
mechanism: by reference

Receives the attributes bit mask for this key definition. The **attributes** argument is the address of a longword into which is written the bit mask describing the key's attributes.

Valid values are as follows:

| | |
|----------------------|--|
| SMG\$M_KEY_NOECHO | If set, this bit specifies that equiv_string is not to be echoed when this key is pressed. If clear, equiv_string is echoed. If SMG\$M_KEY_TERMINATE is not set, SMG\$M_KEY_NOECHO is ignored. |
| SMG\$M_KEY_TERMINATE | If set, this bit specifies that when this key is pressed (as qualified by if-state), the input line is complete and more characters should not be accepted. If clear, more characters may be accepted. |
| SMG\$M_KEY_LOCKSTATE | If set, and if state-string is specified, the state name specified by state-string remains at the current state until explicitly changed by a subsequent keystroke whose definition includes a state-string . If clear, the state name specified by state-string remains in effect only for the next defined key stroke. |
| SMG\$M_KEY_PROTECTED | If set, this bit specifies that this key definition cannot be modified or deleted. If clear, the key definition can be modified or deleted. |

equivalence-string

OpenVMS usage: char_string
type: character string
access: write only
mechanism: by descriptor

Receives the equivalence string for this key definition. The **equivalence-string** argument is the address of a descriptor pointing to the string into which is written the equivalence string.

state-string

OpenVMS usage: char_string
type: character string
access: write only
mechanism: by descriptor

Receives the new state name, if any, which is set by this key definition. The **state-string** argument is the address of a descriptor pointing to the string into which is written the new state string.

SMG\$ Routines

SMG\$GET_KEY_DEF

Description

SMG\$GET_KEY_DEF returns the key definition associated with a specified **key-name** and **if-state**. This key definition may be used in calls to SMG\$READ_COMPOSED_LINE.

Condition Values Returned

| | |
|-----------------|-------------------------------|
| SS\$_NORMAL | Normal successful completion. |
| SMG\$_INVKEYNAM | Invalid key-name . |
| SMG\$_INVKTB_ID | Invalid key-table-id . |
| SMG\$_KEYNOTDEF | Key not defined. |
| SMG\$_WRONUMARG | Wrong number of arguments. |

Any condition values returned by LIB\$SCOPY_DXDX.

SMG\$GET_NUMERIC_DATA

Get Numeric Terminal Data

The Get Numeric Terminal Data routine accesses TERMTABLE.EXE and returns the value associated with a specified Boolean or numeric capability.

Format

SMG\$GET_NUMERIC_DATA *termtable-address* ,*request-code* ,*buffer-address*

Returns

OpenVMS usage: *cond_value*
 type: longword (unsigned)
 access: write only
 mechanism: by value

Arguments

termtable-address

OpenVMS usage: *address*
 type: longword (unsigned)
 access: read only
 mechanism: by reference

Specifies the address of the TERMTABLE entry for the desired terminal. The **termtable-address** argument is the address of an unsigned longword that contains the address of the terminal capabilities table (TERMTABLE).

Before calling SMG\$GET_NUMERIC_DATA, you must obtain this terminal table address by calling either SMG\$INIT_TERM_TABLE or SMG\$INIT_TERM_TABLE_BY_TYPE.

request-code

OpenVMS usage: *longword_unsigned*
 type: longword (unsigned)
 access: read only
 mechanism: by reference

Request code that specifies the desired capability. The **request-code** argument is an unsigned longword constant containing this request code. The request code is of the form SMG\$K_ *code*, where *code* corresponds to a keyword in the terminal capabilities table (TERMTABLE), for example, ANSI_CRT. The SMG\$K_ *code* constants can be found in the library supplied by Compaq, \$SMGTRMPTR.

See Table 5-1, Table 5-2, Table 5-3, and Table 5-4 for valid capability fields.

buffer-address

OpenVMS usage: *address*
 type: longword (unsigned)
 access: write only
 mechanism: by reference

Address of the first byte of the longword to which SMG\$GET_NUMERIC_DATA writes the numeric capability data. The **buffer-address** argument is an unsigned longword that contains the address of this buffer.

SMG\$ Routines

SMG\$GET_NUMERIC_DATA

Description

SMG\$GET_NUMERIC_DATA extracts the requested numeric information from a specified terminal table. Before calling SMG\$GET_NUMERIC_DATA, you must obtain that terminal table address by calling either SMG\$INIT_TERM_TABLE or SMG\$INIT_TERM_TABLE_BY_TYPE. This routine need only be used if you are doing your own TERMTABLE access, and only when you perform direct (non-SMG\$) I/O to terminals.

Condition Values Returned

| | |
|----------------|---------------------------------|
| SS\$NORMAL | Normal successful completion. |
| SMG\$INVREQCOD | Invalid request code. |
| SMG\$INVTERTAB | Invalid terminal table address. |

SMG\$GET_PASTEBOARD_ATTRIBUTES

Get Pasteboard Attributes

The Get Pasteboard Attributes routine gets pasteboard attributes and stores them in the pasteboard information table.

Format

```
SMG$GET_PASTEBOARD_ATTRIBUTES  pasteboard-id ,pasteboard-info-table  
                                ,pasteboard-info-table-size
```

Returns

OpenVMS usage: cond_value
type: longword (unsigned)
access: write only
mechanism: by value

Arguments

pasteboard-id

OpenVMS usage: identifier
type: longword (unsigned)
access: read only
mechanism: by reference

Specifies the pasteboard for which information is requested. The **pasteboard-id** argument is the address of an unsigned longword that contains the pasteboard identifier.

The pasteboard identifier is returned by SMG\$CREATE_PASTEBOARD.

pasteboard-info-table

OpenVMS usage: unspecified
type: unspecified
access: write only
mechanism: by reference, array reference

Receives the pasteboard attributes. The **pasteboard-info-table** argument is the address of a data structure into which are written the pasteboard attributes.

The values in the **pasteboard-info-table** can be accessed through the following symbolic names:

| | |
|-------------------|---|
| SMG\$L_DEVCHAR | Device characteristics (longword). |
| SMG\$L_DEVDEPEND | Specific characteristics 1 (longword). |
| SMG\$L_DEVDEPEND2 | Specific characteristics 2 (longword). |
| SMG\$L_DEVDEPEND3 | Specific characteristics 3 (longword). |
| SMG\$B_DEVCLASS | Device class (byte)—for example, DC\$_TERM. |

SMG\$ Routines

SMG\$GET_PASTEBOARD_ATTRIBUTES

| | |
|------------------------|--|
| SMG\$B_SMG_DEVTYPE | Internal SMG device type (byte). The four possible values for SMG\$B_SMG_DEVTYPE are as follows: SMG\$K_UNKNOWN SMG\$K_VTForeign SMG\$K_HARDCOPY SMG\$K_VTTERMTABLE |
| SMG\$B_PHY_DEVTYPE | Physical device type (byte)—for example, TT\$VT100. The possible values for SMG\$B_PHY_DEVTYPE are defined in \$TTDEF in STARLET. |
| SMG\$B_ROWS | Number of rows on pasteboard (byte). |
| SMG\$W_WIDTH | Pasteboard width (word). |
| SMG\$B_COLOR | Background color setting (byte). Valid values for SMG\$B_COLOR are as follows: SMG\$C_COLOR_UNKNOWN Unknown background color SMG\$C_COLOR_WHITE Light background SMG\$C_COLOR_BLACK Dark background SMG\$C_COLOR_BLUE Blue background SMG\$C_COLOR_CYAN Cyan (green-blue) background SMG\$C_COLOR_GREEN Green background SMG\$C_COLOR_MAGENTA Magenta background SMG\$C_COLOR_RED Red background SMG\$C_COLOR_YELLOW Yellow background SMG\$C_COLOR_LIGHT White background SMG\$C_COLOR_DARK Black background SMG\$C_COLOR_USER1 User-defined background 1 SMG\$C_COLOR_USER2 User-defined background 2 |
| SMG\$B_PARITY | Parity attributes (byte)—this field is zero if the pasteboard is not a terminal. |
| SMG\$W_SPEED | Terminal speed (word)—this field is zero if the pasteboard is not a terminal. |
| SMG\$W_FILL | Fill characteristics (word)—this field is zero if the pasteboard is not a terminal. |
| SMG\$W_PHYS_CURSOR_ROW | Pasteboard row containing physical cursor (word). |
| SMG\$W_PHYS_CURSOR_COL | Pasteboard column containing physical cursor (word). |
| SMG\$L_CURSOR_DID | Display identifier of topmost display containing physical cursor (longword). |

pasteboard-info-table-size

OpenVMS usage: longword_unsigned
 type: longword (unsigned)
 access: read only
 mechanism: by reference

SMG\$ Routines

SMG\$GET_PASTEBOARD_ATTRIBUTES

Specifies the number of bytes in the pasteboard information table. The **pasteboard-info-table-size** argument is the address of an unsigned longword that contains the size (in bytes) of the pasteboard information table.

The size you specify must be exact. You can specify this size with the symbolic constant `SMG$C_PASTEBOARD_INFO_BLOCK`.

Description

`SMG$GET_PASTEBOARD_ATTRIBUTES` gets pasteboard attributes and stores them in the pasteboard information table.

Condition Values Returned

| | |
|------------------------------|---|
| <code>SS\$_NORMAL</code> | Normal successful completion. |
| <code>SMG\$_INVARG</code> | Incorrect size specified in pasteboard-info-table-size . |
| <code>SMG\$_WRONUMARG</code> | Wrong number of arguments. |

SMG\$GET_PASTING_INFO

Return Pasting Information

Provided that the specified virtual display is currently pasted, the Return Pasting Information routine returns the row and column of the pasting.

Format

```
SMG$GET_PASTING_INFO display-id ,pasteboard-id ,flags [,pasteboard-row]
                    [,pasteboard-column]
```

Returns

OpenVMS usage: cond_value
type: longword (unsigned)
access: write only
mechanism: by value

Arguments

display-id

OpenVMS usage: identifier
type: longword (unsigned)
access: read only
mechanism: by reference

Identifier of the virtual display to be examined. The **display-id** argument is the address of an unsigned longword containing the identifier of this virtual display.

pasteboard-id

OpenVMS usage: identifier
type: longword (unsigned)
access: read only
mechanism: by reference

Identifier of the pasteboard on which the virtual display is pasted. The **pasteboard-id** argument is the address of an unsigned longword containing the identifier of this pasteboard.

flags

OpenVMS usage: mask_longword
type: longword (unsigned)
access: write only
mechanism: by reference

Bit mask indicating the status of the specified virtual display with respect to the specified pasteboard. The **flags** argument is the address of an unsigned longword that contains the flag. Valid values for **flags** are as follows:

- | | |
|-----------------------|--|
| 0 | The virtual display is not pasted to the specified pasteboard. |
| SMG\$M_DISPLAY_PASTED | The virtual display specified by display-id is pasted to the pasteboard specified by the pasteboard-id argument. |

pasteboard-row

OpenVMS usage: longword_signed
type: longword (signed)
access: write only
mechanism: by reference

Row of the pasteboard that contains row 1 of the specified virtual display. The optional **pasteboard-row** argument is the address of a signed longword containing the number of the pasteboard row that contains the first row of the virtual display.

pasteboard-column

OpenVMS usage: longword_signed
type: longword (signed)
access: write only
mechanism: by reference

Column of the pasteboard that contains column 1 of the specified virtual display. The optional **pasteboard-column** argument is the address of a signed longword containing the number of the pasteboard column that contains the first column of the virtual display.

Description

SMG\$GET_PASTING_INFO first checks to see if the virtual display specified by **display-id** is pasted to the pasteboard specified by **pasteboard-id**. If this virtual display is pasted to this pasteboard, SMG\$GET_PASTING_INFO returns the row and column numbers of the pasteboard that correspond to row 1 and column 1 of the pasted virtual display.

Condition Values Returned

| | |
|----------------|--------------------------------|
| SS\$NORMAL | Normal successful completion. |
| SMG\$ILLBATFNC | Display is batched. |
| SMG\$INVDIS_ID | Invalid display-id . |
| SMG\$INVPAS_ID | Invalid pasteboard-id . |
| SMG\$WRONUMARG | Wrong number of arguments. |

SMG\$GET_TERM_DATA

Get Terminal Data

The Get Terminal Data routine accesses TERMTABLE.EXE and returns the character sequence that causes a terminal to perform a specified operation.

Format

SMG\$GET_TERM_DATA *termtable-address* ,*request-code* ,*maximum-buffer-length*
,*return-length* ,*capability-data* [,*input-argument-vector*]

Returns

OpenVMS usage: *cond_value*
type: longword (unsigned)
access: write only
mechanism: by value

Arguments

termtable-address

OpenVMS usage: *address*
type: longword (unsigned)
access: read only
mechanism: by reference

Specifies the address of the TERMTABLE entry for the desired terminal. The **termtable-address** argument is the address of an unsigned longword that contains the address of the terminal capabilities table (TERMTABLE).

The TERMTABLE address is returned by SMG\$INIT_TERM_TABLE or SMG\$INIT_TERM_TABLE_BY_TYPE.

request-code

OpenVMS usage: *longword_signed*
type: longword (signed)
access: read only
mechanism: by reference

Longword constant of the form SMG\$K_ *code*, where **code** is the name of the desired capability field. The **request-code** argument is the address of a signed longword that contains the request code. The SMG\$K_ *code* constants can be found in the library supplied by Compaq, \$SMGTRMPTR.

See Table 5-1, Table 5-2, Table 5-3, and Table 5-4 for valid capability fields.

maximum-buffer-length

OpenVMS usage: *longword_signed*
type: longword (signed)
access: read only
mechanism: by reference

Maximum length of the buffer into which the requested capability data is written. The **maximum-buffer-length** argument is the address of a signed longword that contains the maximum number of bytes that can be written into the buffer.

return-length

OpenVMS usage: longword_signed
type: longword (signed)
access: write only
mechanism: by reference

Receives the number of bytes actually written into the buffer. The **return-length** argument is the address of a signed longword into which is written the number of bytes transferred into the buffer.

capability-data

OpenVMS usage: unspecified
type: unspecified
access: by reference, array reference

Address of the first byte of the buffer which is to receive the capability data. The **capability-data** argument contains the address of the buffer.

input-argument-vector

OpenVMS usage: vector_longword_unsigned
type: longword (unsigned)
access: read only
mechanism: by reference, array reference

Address of a list of longwords used for capabilities that require a variable number of arguments, and for those that require substitution or arithmetic operations on an argument. The **input-argument-vector** argument is the address of an array of unsigned longwords that contains capability arguments. The first longword must contain the number of arguments that follow.

Description

SMG\$GET_TERM_DATA should be used only when you perform direct (non-SMG\$) I/O to terminals. It accesses the TERMTABLE.EXE entry for the specified type of terminal and returns the character sequence that performs the specified operation. It is up to you to send this character sequence to the terminal.

Condition Values Returned

| | |
|-----------------|---------------------------------|
| SS\$_NORMAL | Normal successful completion. |
| SMG\$_INVREQCOD | Invalid request code. |
| SMG\$_INVTERTAB | Invalid terminal table address. |

SMG\$GET_VIEWPORT_CHAR

Get Characteristics of Display Viewport

The Get Characteristics of Display Viewport routine returns the characteristics of the specified viewport.

Format

```
SMG$GET_VIEWPORT_CHAR  display-id [,viewport-row-start]
                        [,viewport-column-start] [,viewport-number-rows]
                        [,viewport-number-columns]
```

Returns

OpenVMS usage: cond_value
type: longword (unsigned)
access: write only
mechanism: by value

Arguments

display-id

OpenVMS usage: identifier
type: longword (unsigned)
access: read only
mechanism: by reference

Identifier of the virtual display associated with the viewport. The **display-id** argument is the address of an unsigned longword containing this identifier.

viewport-row-start

OpenVMS usage: longword_signed
type: longword (signed)
access: write only
mechanism: by reference

Optional argument that receives the starting row number of the viewport. The **viewport-row-start** argument is the address of a signed longword that receives this row number.

viewport-column-start

OpenVMS usage: longword_signed
type: longword (signed)
access: write only
mechanism: by reference

Optional argument that receives the starting column number of the specified viewport. The **viewport-column-start** argument is the address of a signed longword that receives this column number.

viewport-number-rows

OpenVMS usage: longword_signed
 type: longword (signed)
 access: write only
 mechanism: by reference

Optional argument that receives the number of rows in the specified viewport. The **viewport-number-rows** argument is the address of a signed longword that receives this number.

viewport-number-columns

OpenVMS usage: longword_signed
 type: longword (signed)
 access: write only
 mechanism: by reference

Optional argument that receives the number of columns in the specified viewport. The **viewport-number-columns** argument is the address of a signed longword that receives this number.

Description

SMG\$GET_VIEWPORT_CHAR returns the requested characteristics of the specified viewport.

Condition Values Returned

| | |
|------------------|--|
| SS\$NORMAL | Normal successful completion. |
| SMG\$INVDIS_ID | Invalid display-id . |
| SMG\$NO_WINASSOC | No viewport associated with the virtual display. |
| SMG\$WRONUMARG | Wrong number of arguments. |

Example

```
C+
C This Fortran example demonstrates the use of SMG$GET_VIEWPORT_CHAR.
C The viewport created will start at row 3, column 4. It will consist of
C 7 rows and 29 columns. Note the parameters used in the SMG$CREATE_VIEWPORT
C routine. I request 26 rows and 55 columns, but my viewport is truncated
C to fit.
C-
  IMPLICIT INTEGER (A-Z)
  INCLUDE '($SMGDEF)'

C Create the virtual display. Give it a border.

  ROWS = 4
  COLUMNS = 34

  STATUS = SMG$CREATE_VIRTUAL_DISPLAY
           1 ( ROWS, COLUMNS, DISPLAY1, SMG$M_BORDER )
  IF (.NOT. STATUS) CALL LIB$SIGNAL(%val(STATUS))

C Create the pasteboard.

  STATUS = SMG$CREATE_PASTEBOARD (PASTE1)
  IF (.NOT. STATUS) CALL LIB$SIGNAL(%val(STATUS))

C Put data in the virtual display.
```

SMG\$ Routines

SMG\$GET_VIEWPORT_CHAR

```
STATUS = SMG$PUT_CHARS ( DISPLAY1,
  1 'This is row number 1 of 4, you see', 1, 1 )
IF (.not. STATUS) CALL LIB$SIGNAL(%val(STATUS))

STATUS = SMG$PUT_CHARS ( DISPLAY1,
  1 'This is row number 2 of 4, you see', 2, 1 )
IF (.not. STATUS) CALL LIB$SIGNAL(%val(STATUS))

STATUS = SMG$PUT_CHARS ( DISPLAY1,
  1 'This is row number 3 of 4, you see', 3, 1 )
IF (.not. STATUS) CALL LIB$SIGNAL(%val(STATUS))

STATUS = SMG$PUT_CHARS ( DISPLAY1,
  1 'This is row number 4 of 4, you see', 4, 1 )
IF (.not. STATUS) CALL LIB$SIGNAL(%val(STATUS))

C Paste the virtual display.

STATUS = SMG$COPY_VIRTUAL_DISPLAY(DISPLAY1,DISPLAY2)
IF (.NOT. STATUS) CALL LIB$SIGNAL(%VAL(STATUS))

STATUS = SMG$LABEL_BORDER (DISPLAY1, 'Full Display',,,SMG$M_BOLD)
IF (.NOT. STATUS) CALL LIB$SIGNAL(%VAL(STATUS))

STATUS = SMG$LABEL_BORDER (DISPLAY2,'Viewport',,,SMG$M_BOLD)
IF (.NOT. STATUS) CALL LIB$SIGNAL(%VAL(STATUS))

STATUS = SMG$PASTE_VIRTUAL_DISPLAY ( DISPLAY1, PASTE1, 2, 2 )
IF (.NOT. STATUS) CALL LIB$SIGNAL(%VAL(STATUS))

STATUS = SMG$CREATE_VIEWPORT ( DISPLAY2, 1, 5, 26, 55 )
IF (.NOT. STATUS) CALL LIB$SIGNAL(%VAL(STATUS))

STATUS = SMG$PASTE_VIRTUAL_DISPLAY ( DISPLAY2, PASTE1, 8, 2 )
IF (.NOT. STATUS) CALL LIB$SIGNAL(%VAL(STATUS))

CALL SMG$SET_PHYSICAL_CURSOR(PASTE1, 16, 1)
TYPE *, ' '
TYPE *, LIB$SIGNAL(%VAL(STATUS))

STATUS = SMG$GET_VIEWPORT_CHAR ( DISPLAY2, A, B, C, D )
IF (.NOT. STATUS) CALL LIB$SIGNAL(%VAL(STATUS))

TYPE *, ' '
WRITE(5,7) A,B
7 FORMAT(1X,'Row start = ',I2,8X,'Column start = ',I2)
TYPE *, ' '
WRITE(5,8) C,D
8 FORMAT(1X,'Number of rows = ',I2,4X,'Number of columns = ',I3)

END
```

The output for this program is shown in Figure SMG-26.

Figure SMG-26 Output Generated by SMG\$GET_VIEWPORT_CHAR

```
          Full Display
-----
This is row number 1 of 4, you see
This is row number 2 of 4, you see
This is row number 3 of 4, you see
This is row number 4 of 4, you see

          Viewport
-----
is row number 1 of 4, you see
is row number 2 of 4, you see
is row number 3 of 4, you see
is row number 4 of 4, you see

%SMG-S-WINTRUNCFIT, Viewport truncated to fit
2146623360

Row start = 1           Column start = 5
Number of rows = 4     Number of columns = 30
```

ZK-6425-GE

SMG\$HOME_CURSOR

Home Cursor

The Home Cursor routine moves the virtual cursor to the specified corner of a virtual display.

Format

SMG\$HOME_CURSOR display-id [,position-code]

Returns

OpenVMS usage: cond_value
type: longword (unsigned)
access: write only
mechanism: by value

Arguments

display-id

OpenVMS usage: identifier
type: longword (unsigned)
access: read only
mechanism: by reference

Specifies the virtual display in which the virtual cursor is moved. The **display-id** argument is the address of a longword that contains the display identifier.

The display identifier is returned by SMG\$CREATE_VIRTUAL_DISPLAY.

position-code

OpenVMS usage: longword_unsigned
type: longword (unsigned)
access: read only
mechanism: by reference

Specifies the point to which the virtual cursor moves. The **position-code** argument is the address of a longword that contains the position code.

Valid codes for **position-code** are as follows:

| Code | Meaning |
|-------------------|--|
| SMG\$C_UPPER_LEFT | Row 1, column 1 (the upper left corner). This is the default if position-code is not specified. |
| SMG\$C_LOWER_LEFT | Row <i>n</i> , column 1 (where <i>n</i> is the number of rows in the display). That is, the lower left corner. It is useful to specify this position when accepting input for an upward-scrolling virtual display. |

| Code | Meaning |
|--------------------|--|
| SMG\$C_UPPER_RIGHT | Row 1, column m (where m is the number of columns in the display). That is, the upper right corner. |
| SMG\$C_LOWER_RIGHT | Row n , column m (where n is the number of rows and m is the number of columns in the display). That is, the lower right corner. |

Description

SMG\$HOME_CURSOR moves the virtual cursor to a corner of the specified virtual display, according to the code specified in the **position-code** argument. You do not need to know the dimensions of the virtual display, or the virtual cursor location. If you omit the **position-code** argument, SMG\$HOME_CURSOR moves the virtual display cursor to the upper left corner of the virtual display.

Condition Values Returned

| | |
|----------------|-------------------------------|
| SS\$NORMAL | Normal successful completion. |
| SMG\$INVARG | Invalid argument. |
| SMG\$INVDIS_ID | Invalid display-id . |
| SMG\$WRONUMARG | Wrong number of arguments. |

SMG\$INIT_TERM_TABLE

Initialize Terminal Table

The Initialize Terminal Table routine initializes the TERMTABLE database for the terminal named, so that subsequent calls to SMG\$GET_TERM_DATA can extract information and command strings for that terminal.

Format

SMG\$INIT_TERM_TABLE terminal-name, termtable-address

Returns

OpenVMS usage: cond_value
type: longword (unsigned)
access: write only
mechanism: by value

Arguments

terminal-name

OpenVMS usage: device_name
type: character string
access: read only
mechanism: by descriptor

Specifies the name of the terminal. The **terminal-name** argument is the address of a descriptor pointing to the terminal name. The name must be an entry in TERMTABLE.EXE.

termtable-address

OpenVMS usage: address
type: longword (unsigned)
access: write only
mechanism: by reference

Address of the entry for a particular type of terminal in TERMTABLE.EXE. The **termtable-address** argument is the address of an unsigned longword that contains the address of the terminal capabilities table.

You use this address when calling the SMG\$GET_TERM_DATA procedure for the specified type of terminal. The TERMTABLE address is also returned by SMG\$INIT_TERM_TABLE_BY_TYPE.

Description

SMG\$INIT_TERM_TABLE initializes the TERMTABLE database for the terminal named, so that subsequent calls to SMG\$GET_TERM_DATA can extract information and command strings for that terminal. This routine should be used only when you perform direct (non-SMG\$) I/O to terminals.

SMG\$INIT_TERM_TABLE first searches for TERMTABLE.EXE in the area logically named TERM\$TABLOC. If TERMTABLE.EXE is not found there, the routine searches the global section SMG\$TERMTABLE.

Condition Values Returned

| | |
|-----------------|--|
| SS\$_NORMAL | Normal successful completion. |
| SMG\$_GBLSECMAP | Successful completion. The definition was found in the global TERMTABLE. |
| SMG\$_PRISECMAP | Successful completion. The definition was found in a private TERMTABLE. |
| SMG\$_UNDTERNAM | Undefined terminal name. |
| SMG\$_UNDTERNOP | Undefined terminal. No definition was found for the terminal and no private TERMTABLE was found. |
| SMG\$_UNDTERNOS | Undefined terminal. No definition was found for the terminal and no system TERMTABLE was found. |

SMG\$INIT_TERM_TABLE_BY_TYPE

Initialize TERMTABLE by OpenVMS Terminal Type

The Initialize TERMTABLE by OpenVMS Terminal Type routine initializes the TERMTABLE database for the terminal named, so that subsequent calls to SMG\$GET_TERM_DATA can extract information and command strings for that terminal.

Format

```
SMG$INIT_TERM_TABLE_BY_TYPE terminal-type ,termtable-address  
                                [,terminal-name]
```

Returns

OpenVMS usage: cond_value
type: longword (unsigned)
access: write only
mechanism: by value

Arguments

terminal-type

OpenVMS usage: byte_signed
type: byte (signed)
access: read only
mechanism: by reference

The device type of the terminal, as designated by an OpenVMS symbolic terminal type or by another value returned by the \$GETDVI system service. The **terminal-type** argument is the address of a signed byte that contains the terminal type.

termtable-address

OpenVMS usage: address
type: longword (unsigned)
access: write only
mechanism: by reference

Address of the entry for a particular type of terminal in TERMTABLE.EXE. The **termtable-address** argument is the address of an unsigned longword into which is written the address of a terminal entry.

Use this address when calling the SMG\$GET_TERM_DATA procedure for the specified type of terminal.

terminal-name

OpenVMS usage: device_name
type: character string
access: write only
mechanism: by descriptor

A string into which is written the terminal name associated with the device type. The **terminal-name** argument is the address of a descriptor pointing to the string into which the terminal name is written.

Description

SMG\$INIT_TERM_TABLE_BY_TYPE initializes the TERMTABLE database for the terminal type specified, so that subsequent calls to SMG\$GET_TERM_DATA can extract information and command strings for that type of terminal. This routine should be used only when you perform direct (non-SMG\$) I/O to terminals.

SMG\$INIT_TERM_TABLE_BY_TYPE first searches for TERMTABLE.EXE in the area logically named TERM\$TABLOC. If TERMTABLE.EXE is not found there, the routine searches the global section SMG\$TERMTABLE.

Condition Values Returned

| | |
|-----------------|--|
| SS\$_NORMAL | Normal successful completion. |
| SMG\$_GBLSECMAP | Successful completion. The definition was found in the global TERMTABLE. |
| SMG\$_PRISECMAP | Successful completion. The definition was found in a private TERMTABLE. |
| SMG\$_UNDTERNAM | Undefined terminal name. |
| SMG\$_UNDTERNOP | Undefined terminal. No definition was found for the terminal and no private TERMTABLE was found. |
| SMG\$_UNDTERNOS | Undefined terminal. No definition was found for the terminal and no system TERMTABLE was found. |

SMG\$INSERT_CHARS

Insert Characters

The Insert Characters routine inserts characters into a virtual display.

Format

SMG\$INSERT_CHARS display-id ,character-string ,start-row ,start-column
[,rendition-set] [,rendition-complement] [,character-set]

Returns

OpenVMS usage: cond_value
type: longword (unsigned)
access: write only
mechanism: by value

Arguments

display-id

OpenVMS usage: identifier
type: longword (unsigned)
access: read only
mechanism: by reference

Specifies the virtual display affected. The **display-id** argument is the address of an unsigned longword that contains the display identifier.

The display identifier is returned by SMG\$CREATE_VIRTUAL_DISPLAY.

character-string

OpenVMS usage: char_string
type: character string
access: read only
mechanism: by descriptor

The character string to be inserted. The **character-string** argument is the address of a descriptor that points to the string to be inserted.

start-row

OpenVMS usage: longword_signed
type: longword (signed)
access: read only
mechanism: by reference

The row position at which to begin the insertion. The **start-row** argument is the address of a signed longword that contains the row number.

start-column

OpenVMS usage: longword_signed
type: longword (signed)
access: read only
mechanism: by reference

The column position at which to begin the insertion. The **start-column** argument is the address of a signed longword that contains the column number.

rendition-set

OpenVMS usage: mask_longword
 type: longword (unsigned)
 access: read only
 mechanism: by reference

Attribute specifier. The optional **rendition-set** argument is the address of a longword bit mask in which each attribute set causes the corresponding attribute to be set in the display. The following attributes can be specified using the **rendition-set** argument:

- SMG\$M_BLINK Displays blinking characters.
- SMG\$M_BOLD Displays characters in higher-than-normal intensity.
- SMG\$M_REVERSE Displays characters in reverse video; that is, using the opposite of the default rendition of the virtual display.
- SMG\$M_UNDERLINE Displays underlined characters.
- SMG\$M_INVISIBLE Specifies invisible characters; that is, the characters exist in the virtual display but do not appear on the pasteboard.
- SMG\$M_USER1 Displays user-defined attributes.
- through
- SMG\$M_USER8

The **display-id** argument must be specified when you use the **rendition-set** argument.

rendition-complement

OpenVMS usage: mask_longword
 type: longword (unsigned)
 access: read only
 mechanism: by reference

Attribute complement specifier. The optional **rendition-complement** argument is the address of a longword bit mask in which each attribute set causes the corresponding attribute to be complemented in the display. All of the attributes that can be specified with the **rendition-set** argument can be complemented with the **rendition-complement** argument. The **display-id** argument must be specified when you use the **rendition-complement** argument.

The optional arguments **rendition-set** and **rendition-complement** let the user control the attributes of the virtual display. The **rendition-set** argument sets certain virtual display attributes, while **rendition-complement** complements these attributes. If the same bit is specified in both the **rendition-set** and **rendition-complement** parameters, **rendition-set** is evaluated first, followed by **rendition-complement**. By using these two parameters together, the user can control each virtual display attribute in a single procedure call. On a single-attribute basis, the user can cause the following transformations:

| Set | Complement | Action |
|-----|------------|--|
| 0 | 0 | Attribute set to default |
| 1 | 0 | Attribute on |
| 0 | 1 | Attribute set to complement of default setting |

SMG\$ Routines

SMG\$INSERT_CHARS

| Set | Complement | Action |
|-----|------------|---------------|
| 1 | 1 | Attribute off |

character-set

OpenVMS usage: longword_unsigned
type: longword (unsigned)
access: read only
mechanism: by reference

Specifies the default character set for all text in this virtual display. The **character-set** argument is the address of an unsigned longword that contains the character set code. Valid values are SMG\$C_ASCII (the default) and SMG\$C_SPEC_GRAPHICS.

Description

SMG\$INSERT_CHARS inserts the specified character string at the **start-row** and **start-column** positions specified. Characters to the right of the insertion are shifted to the right. Any characters that do not fit on the current line are discarded. The virtual cursor remains at the character position following the last character inserted.

Condition Values Returned

| | |
|----------------|-------------------------------------|
| SS\$NORMAL | Normal successful completion. |
| SMG\$INVARG | Unrecognized rendition code. |
| SMG\$INVCOL | Invalid column. |
| SMG\$INVDIS_ID | Invalid display-id . |
| SMG\$INVROW | Invalid row. |
| SMG\$WILUSERMS | Pasteboard is not a video terminal. |
| SMG\$WRONUMARG | Wrong number of arguments. |
| LIB\$INVSTRDES | Invalid string descriptor. |

Example

```
C+
C This Fortran example program demonstrates the use of SMG$INSERT_CHARS.
C-

      IMPLICIT INTEGER (A-Z)
      INCLUDE '($SMGDEF)'
```

```
C+
C Use SMG$CREATE_VIRTUAL_DISPLAY to create a virtual display
C with a border.
C-

      ROWS = 7
      COLUMNS = 50

      STATUS = SMG$CREATE_VIRTUAL_DISPLAY
1      (ROWS, COLUMNS, DISPLAY1, SMG$M_BORDER)
      IF (.NOT. STATUS) CALL LIB$SIGNAL(%VAL(STATUS))
```

```
C+
C Call SMG$CREATE_PASTEBOARD to create the pasteboard.
C-
```

SMG\$ Routines SMG\$INSERT_CHARS

```
STATUS = SMG$CREATE_PASTEBOARD (PASTE1)
IF (.NOT. STATUS) CALL LIB$SIGNAL(%VAL(STATUS))

C+
C Put data in the virtual display by calling SMG$PUT_CHARS.
C-

STATUS = SMG$PUT_CHARS ( DISPLAY1,
1 ' This virtual display has 7 rows and 50 columns.', 2, 1 )
IF (.NOT. STATUS) CALL LIB$SIGNAL(%VAL(STATUS))

STATUS = SMG$PUT_CHARS ( DISPLAY1,
1 ' This is a bordered virtual display.', 4, 1 )
IF (.NOT. STATUS) CALL LIB$SIGNAL(%VAL(STATUS))

STATUS = SMG$PUT_CHARS ( DISPLAY1,
1 ' SMG$PUT_CHARS puts data in this virtual display.', 6, 1 )
IF (.NOT. STATUS) CALL LIB$SIGNAL(%VAL(STATUS))

C+
C Use SMG$PASTE_VIRTUAL_DISPLAY to paste the virtual display.
C-

STATUS = SMG$PASTE_VIRTUAL_DISPLAY ( DISPLAY1, PASTE1, 4, 15 )
IF (.NOT. STATUS) CALL LIB$SIGNAL(%VAL(STATUS))

C+
C Call SMG$INSERT_CHARS to add a row 1 of text, starting at column 6.
C Underline these characters.
C-

STATUS = SMG$INSERT_CHARS ( DISPLAY1,
1 'This is a new row.', 1, 6, SMG$M_UNDERLINE )
IF (.NOT. STATUS) CALL LIB$SIGNAL(%VAL(STATUS))

C+
C Calling SMG$INSERT_CHARS again, add text to row 6.
C Note that there will be some characters that will no
C longer fit on the line. They will be discarded. The
C new text will be bolded.
C-

STATUS = SMG$INSERT_CHARS ( DISPLAY1,
1 'to this bordered display.', 6, 28, SMG$M_BOLD )
IF (.NOT. STATUS) CALL LIB$SIGNAL(%VAL(STATUS))

END
```

The output generated by this Fortran program before the call to SMG\$INSERT_CHARS is shown in Figure SMG-27.

SMG\$ Routines
SMG\$INSERT_CHARS

Figure SMG-27 Output Generated by Fortran Program Before the Call to SMG\$INSERT_CHARS

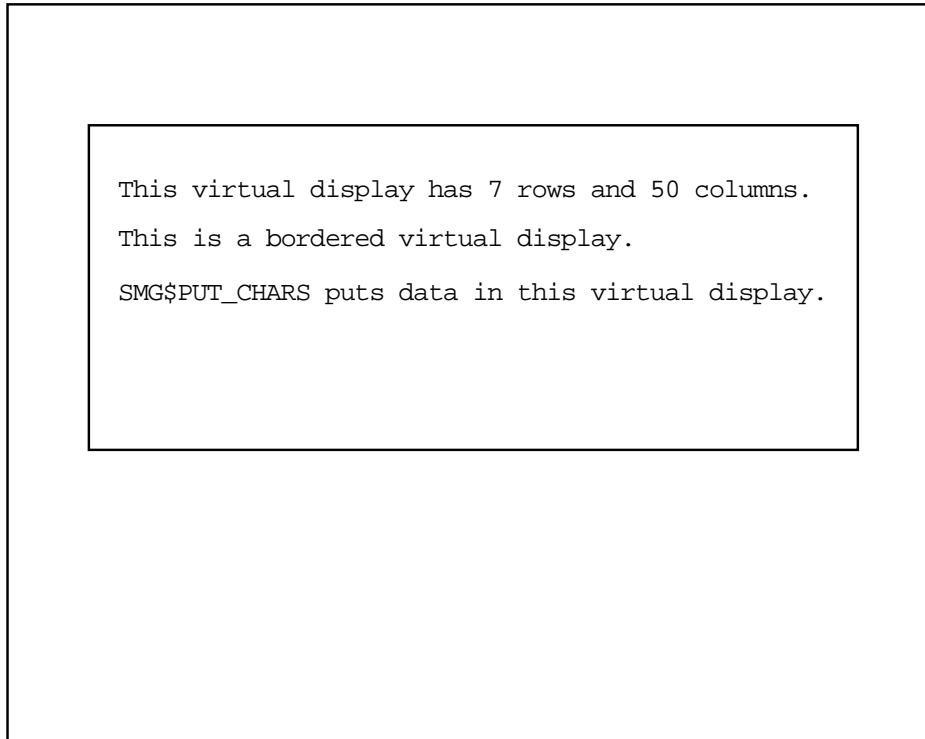

ZK-4132-GE

The output generated by this Fortran program after the call to SMG\$INSERT_CHARS is shown in Figure SMG-28.

Figure SMG-28 Output Generated by Fortran Program After the Call to SMG\$INSERT_CHARS

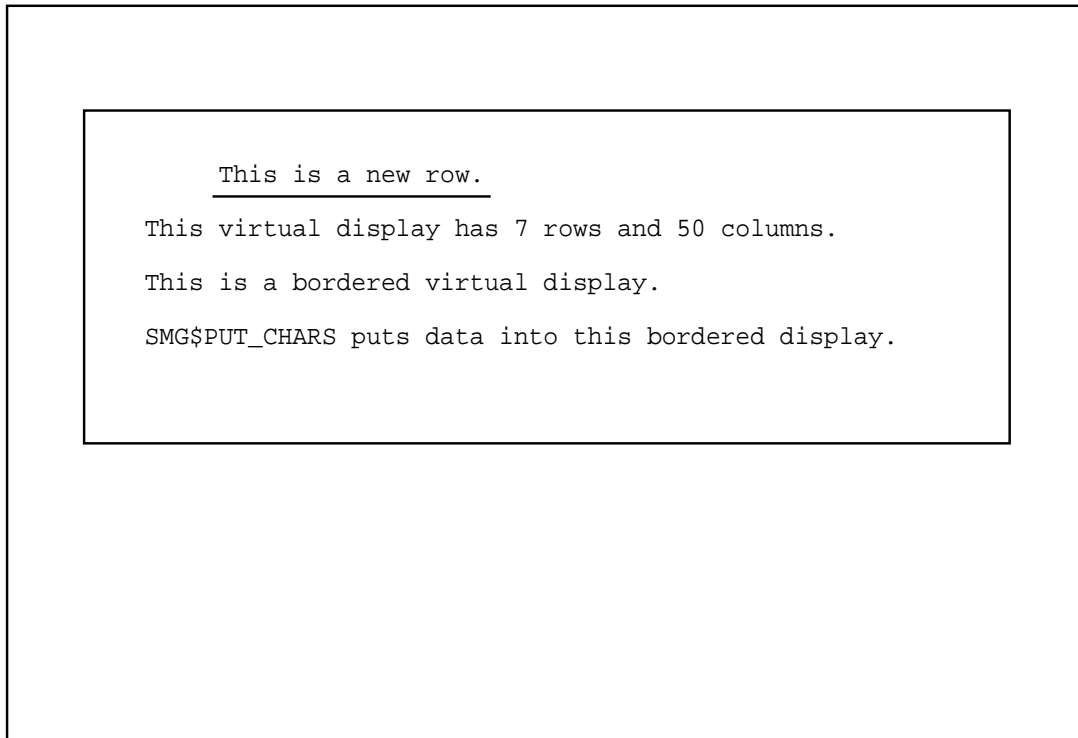

```
          This is a new row.  
This virtual display has 7 rows and 50 columns.  
This is a bordered virtual display.  
SMG$PUT_CHARS puts data into this bordered display.
```

ZK-4144-GE

SMG\$INSERT_LINE

Insert Line

The Insert Line routine inserts a line into a virtual display and scrolls the display.

Format

```
SMG$INSERT_LINE  display-id ,start-row [,character-string] [,direction]
                  [,rendition-set] [,rendition-complement] [,flags] [,character-set]
```

Returns

OpenVMS usage: cond_value
type: longword (unsigned)
access: write only
mechanism: by value

Arguments

display-id

OpenVMS usage: identifier
type: longword (unsigned)
access: read only
mechanism: by reference

Specifies the virtual display affected. The **display-id** argument is the address of an unsigned longword that contains the display identifier.

The display identifier is returned by SMG\$CREATE_VIRTUAL_DISPLAY.

start-row

OpenVMS usage: longword_signed
type: longword (signed)
access: read only
mechanism: by reference

Specifies the row number at which the string is inserted and at which scrolling begins. The **start-row** argument is the address of a signed longword that contains the row number.

character-string

OpenVMS usage: char_string
type: character string
access: read only
mechanism: by descriptor

The character string to be inserted by SMG\$INSERT_LINE. The **character-string** argument is the address of a descriptor pointing to this string.

direction

OpenVMS usage: mask_longword
type: longword (unsigned)
access: read only
mechanism: by reference

Specifies the scrolling direction. The **direction** argument is the address of a longword bit mask that contains the direction code. Valid values are SMG\$M_UP and SMG\$M_DOWN. SMG\$M_UP is the default.

rendition-set

OpenVMS usage: mask_longword
 type: longword (unsigned)
 access: read only
 mechanism: by reference

Attribute specifier. The optional **rendition-set** argument is the address of a longword bit mask in which each attribute set causes the corresponding attribute to be set in the display. The following attributes can be specified using the **rendition-set** argument:

- SMG\$M_BLINK Displays blinking characters.
- SMG\$M_BOLD Displays characters in higher-than-normal intensity.
- SMG\$M_REVERSE Displays characters in reverse video; that is, using the opposite of the default rendition of the virtual display.
- SMG\$M_UNDERLINE Displays underlined characters.
- SMG\$M_INVISIBLE Specifies invisible characters; that is, the characters exist in the virtual display but do not appear on the pasteboard.
- SMG\$M_USER1 Displays user-defined attributes.
- through SMG\$M_
- USER8

The **display-id** argument must be specified when you use the **rendition-set** argument.

rendition-complement

OpenVMS usage: mask_longword
 type: longword (unsigned)
 access: read only
 mechanism: by reference

Attribute complement specifier. The optional **rendition-complement** argument is the address of a longword bit mask in which each attribute set causes the corresponding attribute to be complemented in the display. All of the attributes that can be specified with the **rendition-set** argument can be complemented with the **rendition-complement** argument. The **display-id** argument must be specified when you use the **rendition-complement** argument.

The optional arguments **rendition-set** and **rendition-complement** let the user control the attributes of the virtual display. The **rendition-set** argument sets certain virtual display attributes, while **rendition-complement** complements these attributes. If the same bit is specified in both the **rendition-set** and **rendition-complement** parameters, **rendition-set** is evaluated first, followed by **rendition-complement**. By using these two parameters together, the user can control each virtual display attribute in a single procedure call. On a single-attribute basis, the user can cause the following transformations:

SMG\$ Routines

SMG\$INSERT_LINE

| Set | Complement | Action |
|-----|------------|--|
| 0 | 0 | Attribute set to default |
| 1 | 0 | Attribute on |
| 0 | 1 | Attribute set to complement of default setting |
| 1 | 1 | Attribute off |

flags

OpenVMS usage: mask_longword
type: longword (unsigned)
access: read only
mechanism: by reference

Optional bit mask that specifies the action to take if the text does not fit on the line. The **flags** argument is the address of an unsigned longword that contains the flag. Valid values for **flags** are as follows:

| | |
|------------------|---|
| 0 | Does not wrap (the default) |
| SMG\$M_WRAP_CHAR | Wraps at the last character on the line |
| SMG\$M_WRAP_WORD | Wraps at the last space on the line |

character-set

OpenVMS usage: longword_unsigned
type: longword (unsigned)
access: read only
mechanism: by reference

Specifies the default character set for all text in this virtual display. The **character-set** argument is the address of an unsigned longword that contains the character set code. Valid values are SMG\$C_ASCII (the default) and SMG\$C_SPEC_GRAPHICS.

Description

SMG\$INSERT_LINE lets you insert a line into a virtual display at a location other than the first or last line. Existing lines are scrolled in the specified direction to create an open space. If you specify a **character-string** argument, that string is written in the space created; otherwise, the new line remains blank. If the string does not span the width of the display, it is padded with blanks.

If the value of **flags** is SMG\$M_WRAP_WORD or SMG\$M_WRAP_CHAR and the specified **character-string** is longer than the width of the virtual display, SMG\$INSERT_LINE scrolls another line and writes the excess characters in the created space. If **flags** is 0, any excess characters are discarded. The virtual cursor remains at the character position following the last character written.

See SMG\$PUT_LINE to add lines and scroll at the first or last line in a virtual display.

Condition Values Returned

| | |
|----------------|--|
| SS\$NORMAL | Normal successful completion. |
| SMG\$INVARG | Invalid argument. The specified direction is not up or down. |
| SMG\$INVCOL | Invalid column. |
| SMG\$INVDIS_ID | Invalid display-id . |
| SMG\$INVROW | Invalid row. |
| SMG\$WILUSERMS | Pasteboard is not a video terminal. |
| SMG\$WRONUMARG | Wrong number of arguments. |

Example

```

C+
C This Fortran example program demonstrates the use of SMG$INSERT_LINE.
C
C Include the SMG definitions. In particular, we want SMG$M_BORDER,
C SMG$M_UNDERLINE, and SMG$M_UP.
C-

      IMPLICIT INTEGER (A-Z)
      INCLUDE '($SMGDEF)'

C+
C Use SMG$CREATE_VIRTUAL_DISPLAY to create a virtual display
C with a border.
C-

      ROWS = 7
      COLUMNS = 50

      STATUS = SMG$CREATE_VIRTUAL_DISPLAY
1      (ROWS, COLUMNS, DISPLAY1, SMG$M_BORDER)
      IF (.NOT. STATUS) CALL LIB$SIGNAL(%VAL(STATUS))

C+
C Call SMG$CREATE_PASTEBOARD to create the pasteboard.
C-

      STATUS = SMG$CREATE_PASTEBOARD (PASTE1)
      IF (.NOT. STATUS) CALL LIB$SIGNAL(%VAL(STATUS))

C+
C Use SMG$PUT_CHARS to put data in the virtual display.
C-

      STATUS = SMG$PUT_CHARS ( DISPLAY1,
1      ' This virtual display has 7 rows and 50 columns.', 2, 1 )
      IF (.NOT. STATUS) CALL LIB$SIGNAL(%VAL(STATUS))

      STATUS = SMG$PUT_CHARS ( DISPLAY1,
1      ' This is a bordered virtual display.', 4, 1 )
      IF (.NOT. STATUS) CALL LIB$SIGNAL(%VAL(STATUS))

      STATUS = SMG$PUT_CHARS ( DISPLAY1,
1      ' SMG$PUT_CHARS puts data in this virtual display.', 6, 1 )
      IF (.NOT. STATUS) CALL LIB$SIGNAL(%VAL(STATUS))

C+
C Paste the virtual display by calling SMG$PASTE_VIRTUAL_DISPLAY.
C-

      STATUS = SMG$PASTE_VIRTUAL_DISPLAY ( DISPLAY1, PASTE1, 4, 15 )
      IF (.NOT. STATUS) CALL LIB$SIGNAL(%VAL(STATUS))

```

SMG\$ Routines

SMG\$INSERT_LINE

```
C+
C Call SMG$INSERT_LINE to add a line of text after line 6 and scroll
C the display. Also, underline the new characters.
C-
      STATUS = SMG$INSERT_LINE ( DISPLAY1, 7,
1      'This is a new line.', SMG$M_UP, SMG$M_UNDERLINE )
      IF (.NOT. STATUS) CALL LIB$SIGNAL(%VAL(STATUS))
      END
```

The initial output generated by this Fortran program is shown in Figure SMG-29.

Figure SMG-29 Output Generated Before the Call to SMG\$INSERT_LINE

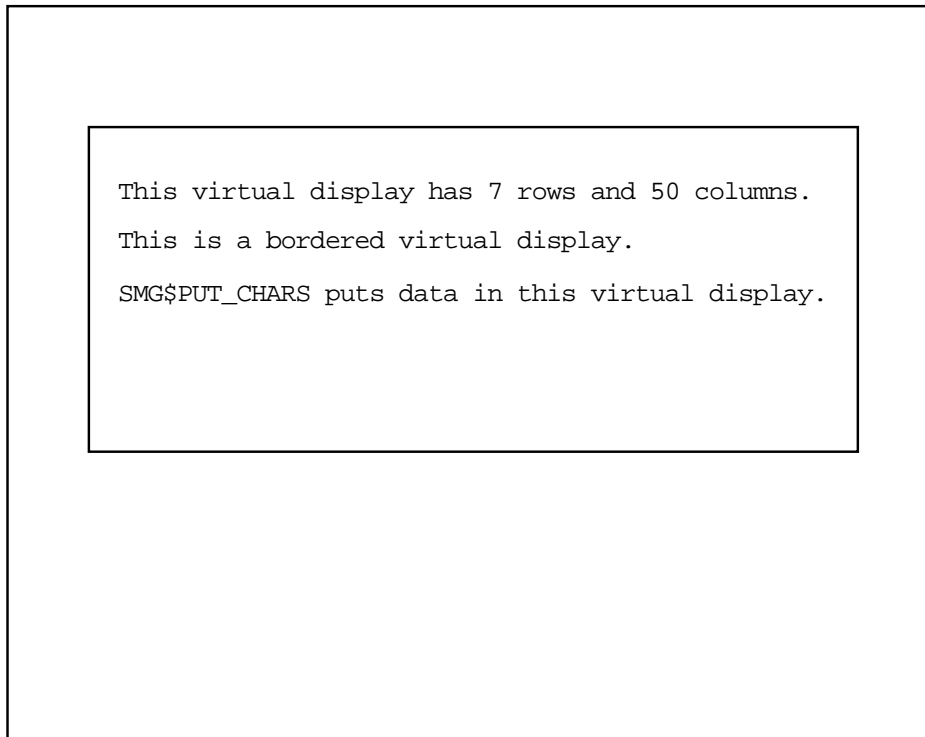

ZK-4132-GE

The output generated after the call to SMG\$INSERT_LINE is shown in Figure SMG-30.

Figure SMG-30 Output Generated After the Call to SMG\$INSERT_LINE

```
This virtual display has 7 rows and 50 columns.  
This is a bordered virtual display.  
SMG$PUT_CHARS puts data in this virtual display.  
This is a new row.
```

ZK-4131-GE

SMG\$INVALIDATE_DISPLAY

Mark a Display as Invalid

The Mark a Display as Invalid routine marks a display as invalid and causes the entire display to be redrawn.

Format

SMG\$INVALIDATE_DISPLAY display-id

Returns

OpenVMS usage: cond_value
type: longword (unsigned)
access: write only
mechanism: by value

Argument

display-id
OpenVMS usage: identifier
type: longword (unsigned)
access: read only
mechanism: by reference

Specifies the virtual display affected. The **display-id** argument is the address of an unsigned longword that contains the display identifier.

The display identifier is returned by SMG\$CREATE_VIRTUAL_DISPLAY.

Description

SMG\$INVALIDATE_DISPLAY marks a display as invalid and redraws the entire display. You would normally use this routine after you determine that output has been written to the display without benefit of the Screen Management Facility.

This routine redraws the virtual display by invalidating the pasteboard contents of the virtual display's "footprint." If the display is occluded, only the occluded portion of the occluding virtual display is redrawn; the entire display is not redrawn.

Condition Values Returned

| | |
|-----------------|-------------------------------|
| SS\$NORMAL | Normal successful completion. |
| SMG\$_INVDIS_ID | Invalid display-id . |

SMG\$KEYCODE_TO_NAME

Translate a Key Code into a Key Name

The Translate a Key Code into a Key Name routine translates the key code of a key on the keyboard into its associated key name.

Format

SMG\$KEYCODE_TO_NAME key-code ,key-name

Returns

OpenVMS usage: cond_value
 type: longword (unsigned)
 access: write only
 mechanism: by value

Arguments

key-code

OpenVMS usage: word_unsigned
 type: word (unsigned)
 access: read only
 mechanism: by reference

Specifies the key code to translate into a key name. The **key-code** argument is the address of an unsigned word that contains the key code.

The key code is returned by SMG\$READ_COMPOSED_LINE, SMG\$READ_KEYSTROKE, SMG\$READ_STRING, and SMG\$READ_VERIFY in the **word-terminator-code** argument.

key-name

OpenVMS usage: char_string
 type: character string
 access: write only
 mechanism: by descriptor

String containing the name of the key into which **key-code** is to be translated. The **key-name** argument is the address of a descriptor pointing to the character string containing the key name. The **key-name** argument is simply the name of the key (for example, COMMA, PERIOD, KP4, and so forth).

Description

SMG\$KEYCODE_TO_NAME translates the key code of a key on the keyboard into its associated key name. This key code is the same code returned by the SMG\$READ_COMPOSED_LINE, SMG\$READ_KEYSTROKE, SMG\$READ_STRING, and SMG\$READ_VERIFY routines in the **word-terminator-code** argument. The form of **key-code** is SMG\$K_TRM_keyname (for example, SMG\$K_TRM_DELETE).

For more information on terminator values, see Table 3-1.

SMG\$ Routines
SMG\$KEYCODE_TO_NAME

Condition Values Returned

SS\$_NORMAL

Normal successful completion.

SMG\$_INVKEYNAM

Invalid **key-name**.

SMG\$LABEL_BORDER

Label a Virtual Display Border

The Label a Virtual Display Border routine supplies a label for a virtual display's border.

Format

```
SMG$LABEL_BORDER  display-id [,text] [,position-code] [,units] [,rendition-set]
                  [,rendition-complement] [,character-set]
```

Returns

OpenVMS usage: cond_value
 type: longword (unsigned)
 access: write only
 mechanism: by value

Arguments

display-id

OpenVMS usage: identifier
 type: longword (unsigned)
 access: read only
 mechanism: by reference

Specifies the virtual display affected. The **display-id** argument is the address of an unsigned longword that contains the display identifier.

The display identifier is returned by SMG\$CREATE_VIRTUAL_DISPLAY.

text

OpenVMS usage: char_string
 type: character string
 access: read only
 mechanism: by descriptor

The new label for this display's border. The **text** argument is the address of a descriptor pointing to the label text. If this string is supplied, it replaces the current label text for this border. If omitted, the display is not labeled.

position-code

OpenVMS usage: longword_unsigned
 type: longword (unsigned)
 access: read only
 mechanism: by reference

Specifies which of the display's borders contains the label. The **position-code** argument is the address of an unsigned longword that contains the position code.

Valid positions are as follows:

- SMG\$K_TOP
- SMG\$K_BOTTOM
- SMG\$K_RIGHT

SMG\$ Routines

SMG\$LABEL_BORDER

- SMG\$K_LEFT

If this argument is omitted, the label is displayed on the top border.

units

OpenVMS usage: longword_signed
type: longword (signed)
access: read only
mechanism: by reference

Specifies the character position at which the label begins within the border. The **units** argument is the address of a signed longword that contains the character position. If omitted, the label is centered in the specified border.

rendition-set

OpenVMS usage: mask_longword
type: longword (unsigned)
access: read only
mechanism: by reference

Attribute specifier. The optional **rendition-set** argument is the address of a longword bit mask in which each attribute set causes the corresponding attribute to be set in the display. The following attributes can be specified using the **rendition-set** argument:

| | |
|---|---|
| SMG\$M_BLINK | Displays blinking characters. |
| SMG\$M_BOLD | Displays characters in higher-than-normal intensity. |
| SMG\$M_REVERSE | Displays characters in reverse video; that is, using the opposite of the default rendition of the virtual display. |
| SMG\$M_UNDERLINE | Displays underlined characters. |
| SMG\$M_INVISIBLE | Specifies invisible characters; that is, the characters exist in the virtual display but do not appear on the pasteboard. |
| SMG\$M_USER1 through SMG\$M_USER8 | Displays user-defined attributes. |

The **display-id** argument must be specified when you use the **rendition-set** argument.

rendition-complement

OpenVMS usage: mask_longword
type: longword (unsigned)
access: read only
mechanism: by reference

Attribute complement specifier. The optional **rendition-complement** argument is the address of a longword bit mask in which each attribute set causes the corresponding attribute to be complemented in the display. All of the attributes that can be specified with the **rendition-set** argument can be complemented with the **rendition-complement** argument. The **display-id** argument must be specified when you use the **rendition-complement** argument.

The optional arguments **rendition-set** and **rendition-complement** let the user control the attributes of the virtual display. The **rendition-set** argument sets certain virtual display attributes, while **rendition-complement** complements these attributes. If the same bit is specified in both the **rendition-set** and **rendition-complement** parameters, **rendition-set** is evaluated first, followed by **rendition-complement**. By using these two parameters together, the user can control each virtual display attribute in a single procedure call. On a single-attribute basis, the user can cause the following transformations:

| Set | Complement | Action |
|-----|------------|--|
| 0 | 0 | Attribute set to default |
| 1 | 0 | Attribute on |
| 0 | 1 | Attribute set to complement of default setting |
| 1 | 1 | Attribute off |

character-set

OpenVMS usage: longword_unsigned
 type: longword (unsigned)
 access: read only
 mechanism: by reference

Specifies the default character set for all text in this virtual display. The **character-set** argument is the address of an unsigned longword that contains the character set code. Valid values are SMG\$C_ASCII (the default) and SMG\$C_SPEC_GRAPHICS.

Description

SMG\$LABEL_BORDER lets you specify text to label a virtual display. If the specified virtual display does not already have the border display attribute (SMG\$M_BORDER), then this attribute is forced. A display border, which includes all four sides of the display, can have only one label. If the label string is supplied, it replaces the current label text for this border. If you supply an empty (null) label string, the border is not labeled. If the label text (as positioned within the border) does not fit within the border, this routine returns SMG\$_INVARG.

The **position-code** and **units** arguments together specify the starting position of the label text within a border. If **position-code** is omitted, the default is the top border. If **units** is omitted, this routine chooses a starting position so as to center the text either horizontally or vertically, depending on the implicit or explicit position argument. If both **position-code** and **units** are omitted, the text is centered in the top border.

Note

The label may shift when it is applied to a viewport. This occurs when the label needs to be moved to appear in a sensible location. For example, the default location for a label in a virtual display is at the top of the display and centered. When a viewport is created, that label may shift to remain in the center of the display.

SMG\$ Routines

SMG\$LABEL_BORDER

Condition Values Returned

| | |
|-----------------|--|
| SS\$_NORMAL | Normal successful completion. |
| SMG\$_INVARG | Invalid argument. The combination of position-code , units , and text arguments resulted in a position outside the border area. |
| SMG\$_INVDIS_ID | Invalid display-id . |
| SMG\$_WRONUMARG | Wrong number of arguments. |

Example

```
C+
C This Fortran example program demonstrates the use of SMG$LABEL_BORDER.
C-

C+
C Include the SMG definitions. In particular, we want SMG$M_BORDER,
C SMG$K_TOP, SMG$K_BOTTOM, and SMG$K_RIGHT.
C-

      IMPLICIT INTEGER (A-Z)
      INCLUDE '($SMGDEF)'

C+
C Call SMG$CREATE_VIRTUAL_DISPLAY to create virtual display number 1.
C Give it a border.
C-

      ROWS = 4
      COLUMNS = 30

      STATUS = SMG$CREATE_VIRTUAL_DISPLAY
1      (ROWS, COLUMNS, DISPLAY1, SMG$M_BORDER)
      IF (.NOT. STATUS) CALL LIB$SIGNAL(%VAL(STATUS))

C+
C Call SMG$CREATE_VIRTUAL_DISPLAY to create virtual display number 2.
C Give it a border.
C-

      ROWS = 3
      COLUMNS = 30

      STATUS = SMG$CREATE_VIRTUAL_DISPLAY
1      (ROWS, COLUMNS, DISPLAY2, SMG$M_BORDER)
      IF (.NOT. STATUS) CALL LIB$SIGNAL(%VAL(STATUS))

C+
C Create virtual display number 3. Do NOT give it a border.
C-

      ROWS = 4
      COLUMNS = 35

      STATUS = SMG$CREATE_VIRTUAL_DISPLAY
1      (ROWS, COLUMNS, DISPLAY3)
      IF (.NOT. STATUS) CALL LIB$SIGNAL(%VAL(STATUS))

C+
C Use SMG$CREATE_PASTEBOARD to create the pasteboard.
C-

      STATUS = SMG$CREATE_PASTEBOARD (PASTE1)
      IF (.NOT. STATUS) CALL LIB$SIGNAL(%VAL(STATUS))
```

SMG\$ Routines SMG\$LABEL_BORDER

```
C+
C Call SMG$PUT_CHARS to put data into the virtual displays.
C-
    STATUS = SMG$PUT_CHARS ( DISPLAY1,
1      ' A bordered virtual display.', 2, 1 )
    IF (.NOT. STATUS) CALL LIB$SIGNAL(%VAL(STATUS))
    STATUS = SMG$PUT_CHARS ( DISPLAY2,
1      ' A bordered virtual display.', 1, 1 )
    IF (.NOT. STATUS) CALL LIB$SIGNAL(%VAL(STATUS))
    STATUS = SMG$PUT_CHARS ( DISPLAY3,
1      ' Started as an unbordered display.', 2, 1 )
    IF (.NOT. STATUS) CALL LIB$SIGNAL(%VAL(STATUS))

C+
C Call SMG$LABEL_BORDER to label the virtual display borders.
C-
    STATUS = SMG$LABEL_BORDER ( DISPLAY1, 'Side', SMG$K_RIGHT )
    IF (.NOT. STATUS) CALL LIB$SIGNAL(%VAL(STATUS))
    STATUS = SMG$LABEL_BORDER ( DISPLAY2, 'LABEL Bottom',
1      SMG$K_BOTTOM, 1 )
    IF (.NOT. STATUS) CALL LIB$SIGNAL(%VAL(STATUS))
    STATUS = SMG$LABEL_BORDER ( DISPLAY3, 'Forced bordering ',
1      SMG$K_TOP )
    IF (.NOT. STATUS) CALL LIB$SIGNAL(%VAL(STATUS))

C+
C Call SMG$PASTE_VIRTUAL_DISPLAY to paste the virtual displays.
C-
    STATUS = SMG$PASTE_VIRTUAL_DISPLAY ( DISPLAY1, PASTE1, 2, 10 )
    IF (.NOT. STATUS) CALL LIB$SIGNAL(%VAL(STATUS))
    STATUS = SMG$PASTE_VIRTUAL_DISPLAY ( DISPLAY2, PASTE1, 2, 45 )
    IF (.NOT. STATUS) CALL LIB$SIGNAL(%VAL(STATUS))
    STATUS = SMG$PASTE_VIRTUAL_DISPLAY ( DISPLAY3, PASTE1, 10, 5 )
    IF (.NOT. STATUS) CALL LIB$SIGNAL(%VAL(STATUS))

    END
```

The output generated by this program is shown in Figure SMG-31.

SMG\$ Routines
SMG\$LABEL_BORDER

Figure SMG-31 Output Generated by Program Calling SMG\$LABEL_BORDER

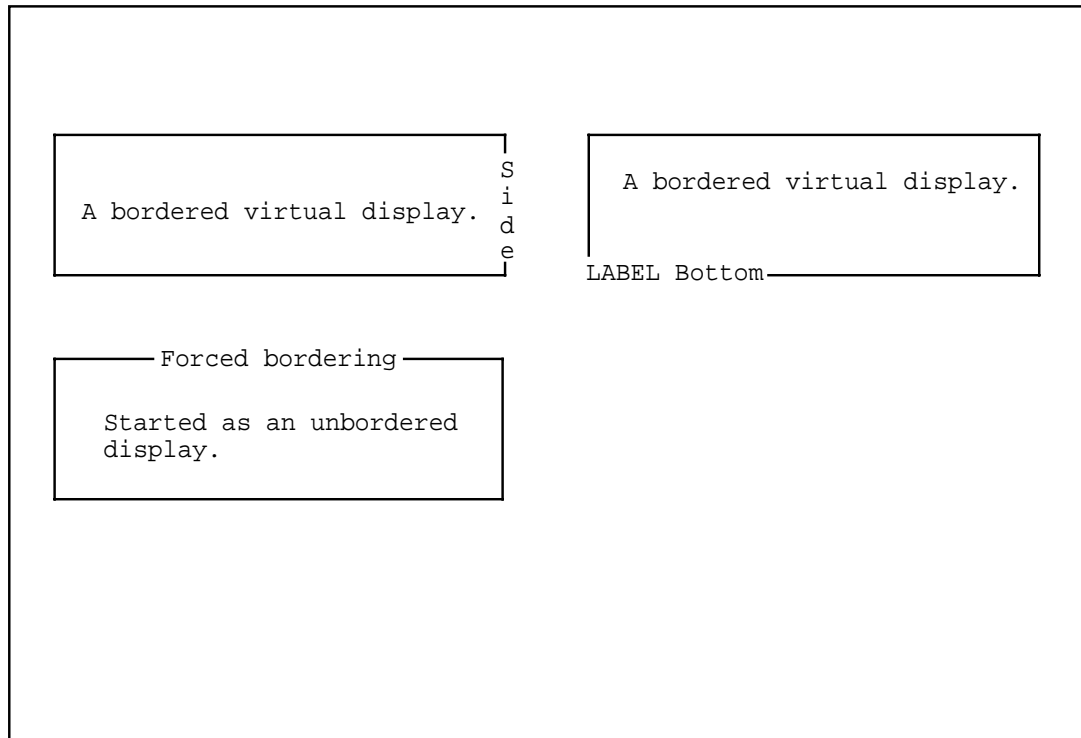

ZK-4127-GE

SMG\$LIST_KEY_DEFS

List Key Definitions

The List Key Definitions routine returns, one at a time, the definitions (equivalence strings) associated with specified keys in a specified key definition table.

Format

```
SMG$LIST_KEY_DEFS  key-table-id ,context [,key-name] [,if-state] [,attributes]
                  [,equivalence-string] [,state-string]
```

Returns

OpenVMS usage: cond_value
 type: longword (unsigned)
 access: write only
 mechanism: by value

Arguments

key-table-id

OpenVMS usage: identifier
 type: longword (unsigned)
 access: read only
 mechanism: by reference

Specifies the key definition table from which you are extracting a key definition. The **key-table-id** argument is the address of an unsigned longword that contains the key table identifier.

The key definition table identifier is returned by SMG\$CREATE_KEY_TABLE.

context

OpenVMS usage: context
 type: longword (unsigned)
 access: modify
 mechanism: by reference

Provides a means to extract a series of key definitions from a key definition table. The **context** argument is the address of an unsigned longword that contains the context variable. For the first call to this routine, you should set the **context** argument to zero.

The **context** argument is incremented by the SMG\$LIST_KEY_DEFS routine so that the next call returns the next key definition.

key-name

OpenVMS usage: char_string
 type: character string
 access: modify
 mechanism: by descriptor

Identifies the key whose value you are listing. The **key-name** argument is the address of a descriptor pointing to the key name.

SMG\$ Routines

SMG\$LIST_KEY_DEFS

if-state

OpenVMS usage: char_string
type: character string
access: write only
mechanism: by descriptor

Receives the state name which qualifies the next definition in the key definition table. The **if-state** argument is the address of a descriptor pointing to the string into which the state name is written.

attributes

OpenVMS usage: mask_longword
type: longword (unsigned)
access: write only
mechanism: by reference

Attributes of this key definition. The **attributes** argument is the address of an unsigned longword into which the key attributes are written.

Possible attributes are as follows:

| | |
|----------------------|---|
| SMG\$M_KEY_NOECHO | If set, this bit specifies that equiv_string is not to be echoed when this key is pressed; if clear, equiv_string is echoed. If SMG\$M_KEY_TERMINATE is not set, SMG\$M_KEY_NOECHO is ignored. |
| SMG\$M_KEY_TERMINATE | If set, this bit specifies that when this key is pressed (as qualified by if-state), the input line is complete and more characters should not be accepted. If clear, more characters may be accepted. |
| SMG\$M_KEY_LOCKSTATE | If set, and if state-string is specified, the state name specified by state-string remains at the current state until explicitly changed by a subsequent keystroke whose definition includes a state-string . If clear, the state name specified by state-string remains in effect only for the next defined keystroke. |
| SMG\$M_KEY_PROTECTED | If set, this bit specifies that this key definition cannot be modified or deleted. If clear, the key definition can be modified or deleted. |

equivalence-string

OpenVMS usage: char_string
type: character string
access: write only
mechanism: by descriptor

The character string into which the equivalence string is written for the next key definition. The **equivalence-string** argument is the address of a descriptor pointing to the string into which **equivalence-string** is written.

state-string

OpenVMS usage: char_string
type: character string
access: write only
mechanism: by descriptor

A string into which is written the new state name, if any, set by the next key definition. The **state-string** argument is the address of a descriptor pointing to the string into which the state name is written. If this key definition sets a state, the attributes flag SMG\$M_KEY_SETSTATE is also set.

Description

SMG\$LIST_KEY_DEFS, when called repeatedly, lets you examine all the definitions in a key definition table. These definitions may be used with the routine SMG\$READ_COMPOSED_LINE.

Condition Values Returned

| | |
|-----------------|-------------------------------|
| SS\$NORMAL | Normal successful completion. |
| SMG\$INVKEYNAM | Invalid key-name . |
| SMG\$INVKTB_ID | Invalid key-table-id . |
| SMG\$NOMOREKEYS | No more keys in this table. |

Any condition value returned by LIB\$SCOPY_DXDX.

SMG\$LIST_PASTEBOARD_ORDER

Return Pasting Information

The Return Pasting Information routine returns the pasteboard identifier of the pasteboard to which the specified virtual display is pasted. Optionally, the pasteboard row 1 and column 1 (origins) of the virtual display are also returned.

Format

```
SMG$LIST_PASTEBOARD_ORDER  display-id ,context ,pasteboard-id  
                             [,pasteboard-row] [,pasteboard-column]
```

Returns

OpenVMS usage: cond_value
type: longword (unsigned)
access: write only
mechanism: by value

Arguments

display-id
OpenVMS usage: identifier
type: longword (unsigned)
access: read only
mechanism: by reference

Display identifier of the virtual display that is pasted. The **display-id** argument is the address of an unsigned longword containing the identifier of this display.

context
OpenVMS usage: context
type: longword (unsigned)
access: modify
mechanism: by reference

Context to search. The **context** argument is the address of an unsigned longword containing this context. On the initial call, you should set **context** to zero. SMG\$LIST_PASTEBOARD_ORDER updates the value of **context**. The updated value should then be passed on the subsequent calls to obtain the next pasted display identifier.

pasteboard-id
OpenVMS usage: identifier
type: longword (unsigned)
access: write only
mechanism: by reference

Receives the identifier of the pasteboard on which the virtual display is pasted. The **pasteboard-id** argument is the address of an unsigned longword containing the identifier of this pasteboard.

pasteboard-row

OpenVMS usage: longword_signed
type: longword (signed)
access: write only
mechanism: by reference

Row of the pasteboard that contains row 1 of the specified virtual display. The optional **pasteboard-row** argument is the address of a signed longword containing the number of the pasteboard row that contains the first row of the virtual display.

pasteboard-column

OpenVMS usage: longword_signed
type: longword (signed)
access: write only
mechanism: by reference

Column of the pasteboard that contains column 1 of the specified virtual display. The optional **pasteboard-column** argument is the address of a signed longword containing the number of the pasteboard column that contains the first column of the virtual display.

Description

SMG\$LIST_PASTEBOARD_ORDER returns the pasteboard identifier of the pasteboard to which the specified virtual display is pasted. Optionally, the pasteboard row 1 and column 1 (origins) of the virtual displays are also returned.

SMG\$LIST_PASTEBOARD_ORDER returns the identifier of the first (or bottom-most) pasteboard to which the specified virtual display is pasted. Call this routine in a loop, once for each succeeding pasteboard, until SMG\$_NOPASTED is returned.

This routine is useful if, for example, you pasted a display to many pasteboards and you no longer know the pasteboard identifier of a pasteboard critical to your application.

Condition Values Returned

| | |
|-----------------|-------------------------------|
| SS\$_NORMAL | Normal successful completion. |
| SMG\$_INVDIS_ID | Invalid display-id . |
| SMG\$_NOPASTED | No more displays are pasted. |
| SMG\$_WRONUMARG | Wrong number of arguments. |

SMG\$LIST_PASTING_ORDER

Return Virtual Display Pasting Information

The Return Virtual Display Pasting Information routine returns the identifiers of the virtual displays pasted to a specified pasteboard. Optionally, the pasteboard row 1 and column 1 (origins) of the virtual displays are also returned.

Format

```
SMG$LIST_PASTING_ORDER  pasteboard-id ,context ,display-id [,pasteboard-row]
                        [,pasteboard-column]
```

Returns

OpenVMS usage: cond_value
type: longword (unsigned)
access: write only
mechanism: by value

Arguments

pasteboard-id
OpenVMS usage: identifier
type: longword (unsigned)
access: read only
mechanism: by reference

Identifier of the pasteboard on which the virtual display is pasted. The **pasteboard-id** argument is the address of an unsigned longword containing the identifier of this pasteboard.

context
OpenVMS usage: context
type: longword (unsigned)
access: modify
mechanism: by reference

Context to search. The **context** argument is the address of an unsigned longword containing this context. On the initial call, you should set **context** to zero. SMG\$LIST_PASTING_ORDER updates the value of **context**. The updated value should then be passed on subsequent calls to obtain the next pasted display identifier.

display-id
OpenVMS usage: identifier
type: longword (unsigned)
access: write only
mechanism: by reference

Identifier of the virtual display that is pasted. The **display-id** argument is the address of an unsigned longword containing the identifier of this virtual display.

pasteboard-row

OpenVMS usage: longword_signed
type: longword (signed)
access: write only
mechanism: by reference

Row of the pasteboard that contains row 1 of the specified virtual display. The optional **pasteboard-row** argument is the address of a signed longword containing the number of the pasteboard row that contains the first row of the virtual display.

pasteboard-column

OpenVMS usage: longword_signed
type: longword (signed)
access: write only
mechanism: by reference

Column of the pasteboard that contains column 1 of the specified virtual display. The optional **pasteboard-column** argument is the address of a signed longword containing the number of the pasteboard column that contains the first column of the virtual display.

Description

SMG\$LIST_PASTING_ORDER returns the identifiers of the virtual displays pasted to a specified pasteboard. Optionally, the pasteboard row 1 and column 1 (origins) of the virtual displays are also returned.

SMG\$LIST_PASTING_ORDER returns the identifier of the first (or bottommost) virtual display pasted. Call this routine in a loop, once for each succeeding pasted virtual display, until SMG\$_NOTPASTED is returned.

This routine is useful if, for example, you created many virtual displays and you no longer know the display identifier of a virtual display critical to your application.

Condition Values Returned

| | |
|-----------------|--------------------------------|
| SS\$_NORMAL | Normal successful completion. |
| SMG\$_INVPAS_ID | Invalid pasteboard-id . |
| SMG\$_NOTPASTED | No more displays are pasted. |
| SMG\$_WRONUMARG | Wrong number of arguments. |

SMG\$LOAD_KEY_DEFS

Load Key Definitions

The Load Key Definitions routine loads a file of key definitions (DEFINE/KEY commands) into a specified key table.

Format

```
SMG$LOAD_KEY_DEFS key-table-id ,filespec [,default-filespec] [,flags]
```

Returns

OpenVMS usage: cond_value
type: longword (unsigned)
access: write only
mechanism: by value

Arguments

key-table-id

OpenVMS usage: identifier
type: longword (unsigned)
access: read only
mechanism: by reference

Specifies the key table into which you are loading key definitions. The **key-table-id** argument is the address of an unsigned longword that contains the key table identifier.

The key table identifier is returned by SMG\$CREATE_KEY_TABLE.

filespec

OpenVMS usage: char_string
type: character string
access: read only
mechanism: by descriptor

String containing the file specification for the file of DEFINE/KEY commands. The **filespec** argument is the address of a descriptor pointing to the file specification.

default-filespec

OpenVMS usage: char_string
type: character string
access: read only
mechanism: by descriptor

String containing the default file specification for the file of DEFINE/KEY commands. The **default-filespec** argument is the address of a descriptor pointing to the default file specification. If omitted, the null string is used.

flags

OpenVMS usage: mask_longword
type: longword (unsigned)
access: read only
mechanism: by reference

Optional bit mask that specifies whether **filespec** is to be treated as a logical name. The **flags** argument is the address of an unsigned longword that contains the flag. If set, **flags** specifies that **filespec** should be translated, but if this is not possible, that the null string be used.

Description

SMG\$LOAD_KEY_DEFS opens and reads a file containing DEFINE/KEY commands and calls SMG\$DEFINE_KEY for each command line in the file. Use of SMG\$LOAD_KEY_DEFS requires that the calling program be run under the DCL command language interpreter (CLI). This routine signals any errors encountered while processing command lines. For more information, see SMG\$DEFINE_KEY.

Condition Values Returned

| | |
|----------------|---|
| SS\$NORMAL | Normal successful completion. |
| SMG\$FILTOOLON | File specification is too long (over 255 characters). |

Any condition values returned by SMG\$DEFINE_KEY or \$OPEN.

SMG\$LOAD_VIRTUAL_DISPLAY

Load a Virtual Display from a File

The Load a Virtual Display from a File routine creates a new virtual display and loads it with a virtual display saved with SMG\$SAVE_VIRTUAL_DISPLAY.

Format

SMG\$LOAD_VIRTUAL_DISPLAY display-id [,filespec]

Returns

OpenVMS usage: cond_value
type: longword (unsigned)
access: write only
mechanism: by value

Arguments

display-id
OpenVMS usage: identifier
type: longword (unsigned)
access: write only
mechanism: by reference

Identifier of the new virtual display to be loaded with the saved virtual display. The **display-id** argument is the address of an unsigned longword into which is written the new display identifier.

filespec
OpenVMS usage: char_string
type: character string
access: read only
mechanism: by descriptor

String containing the file specification of the file in which the specified virtual display is saved. The **filespec** argument is a character string containing the file specification.

If **filespec** is omitted, SMG\$LOAD_VIRTUAL_DISPLAY searches for the default file specification SMGDISPLY.DAT.

Description

SMG\$LOAD_VIRTUAL_DISPLAY creates a new virtual display and loads it with a virtual display saved with SMG\$SAVE_VIRTUAL_DISPLAY. The new virtual display contains text, renditions, and attributes from the saved virtual display, but does not include menu, viewport, and subprocess context. The new virtual display is not pasted to any pasteboard.

Condition Values Returned

| | |
|-----------------|--|
| SS\$_NORMAL | Normal successful completion. |
| SMG\$_INVDIS_ID | Invalid display-id . |
| SMG\$_xxxx | Any condition value returned by SMG\$CREATE_VIRTUAL_DISPLAY. |
| RMSS\$_xxxx | Any error returned by \$OPEN, \$CONNECT, \$PUT, and \$CLOSE. |

SMG\$MOVE_TEXT

Move Text from One Virtual Display to Another

The Move Text from One Virtual Display to Another routine moves a rectangle of text from one virtual display to another virtual display. Given two points in opposite corners of the rectangle, SMG\$MOVE_TEXT determines the desired width and height of the new virtual display.

Format

```
SMG$MOVE_TEXT  display-id ,top-left-row ,top-left-column ,bottom-right-row  
                ,bottom-right-column ,display-id2 [,top-left-row2]  
                [,top-left-column2] [,flags]
```

Returns

OpenVMS usage: cond_value
type: longword (unsigned)
access: write only
mechanism: by value

Arguments

display-id
OpenVMS usage: identifier
type: longword (unsigned)
access: read only
mechanism: by reference

Specifies the virtual display from which text is to be moved. The **display-id** argument is the address of an unsigned longword that contains the display identifier.

The display identifier is returned by SMG\$CREATE_VIRTUAL_DISPLAY.

top-left-row
OpenVMS usage: longword_unsigned
type: longword (unsigned)
access: read only
mechanism: by reference

Top left row of the rectangle of text you want to move. The **top-left-row** argument is the address of an unsigned longword containing the row number.

top-left-column
OpenVMS usage: longword_unsigned
type: longword (unsigned)
access: read only
mechanism: by reference

Top left column of the rectangle of text you want to move. The **top-left-column** argument is the address of an unsigned longword containing the column number.

bottom-right-row

OpenVMS usage: longword_unsigned
type: longword (unsigned)
access: read only
mechanism: by reference

Bottom right row of the rectangle of text you want to move. The **bottom-right-row** argument is the address of an unsigned longword containing the row number.

bottom-right-column

OpenVMS usage: longword_unsigned
type: longword (unsigned)
access: read only
mechanism: by reference

Bottom right column of the rectangle of text you want to move. The **bottom-right-column** argument is the address of an unsigned longword containing the column number.

display-id2

OpenVMS usage: identifier
type: longword (unsigned)
access: read only
mechanism: by reference

Specifies the virtual display to which the text is to be moved. The **display-id2** argument is the address of an unsigned longword that contains the display identifier.

The display identifier **display-id2** is returned by SMG\$CREATE_VIRTUAL_DISPLAY.

top-left-row2

OpenVMS usage: longword_unsigned
type: longword (unsigned)
access: read only
mechanism: by reference

Top left row of the rectangle that is the destination of the text you want to move. The optional **top-left-row2** argument is the address of an unsigned longword containing the row number. If you do not specify a value for **top-left-row2**, the text is moved to the current virtual cursor row.

top-left-column2

OpenVMS usage: longword_unsigned
type: longword (unsigned)
access: read only
mechanism: by reference

Top left column of the rectangle that is the destination of the text you want to move. The optional **top-left-column2** argument is the address of an unsigned longword containing the column number. If you do not specify a value for **top-left-column2**, the text is moved to the current virtual cursor column.

SMG\$ Routines

SMG\$MOVE_TEXT

flags

OpenVMS usage: mask_longword
type: longword (unsigned)
access: read only
mechanism: by reference

Optional bit mask that specifies the action to take when moving the specified text. The **flags** argument is the address of an unsigned longword that contains the flag. The **flags** argument accepts the following values:

| | |
|------------------|--|
| SMG\$M_TEXT_SAVE | Does not erase the text after moving. |
| SMG\$M_TEXT_ONLY | Moves the text but not the attributes. |

Description

SMG\$MOVE_TEXT moves a rectangle of text from one virtual display to another virtual display. You specify the rectangle you want to move with the **top-left-row**, **top-left-column**, **bottom-right-row**, and **bottom-right-column** arguments, as shown in Figure SMG-32. The virtual cursor positions are not changed.

Figure SMG-32 Arguments for Moving Text

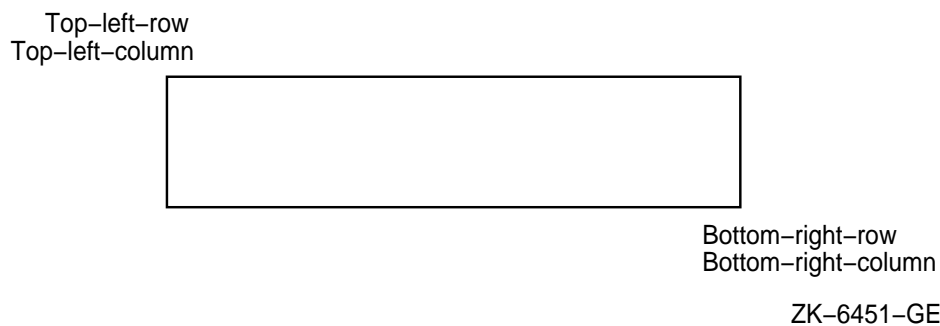

The rectangle of text is moved to the current virtual cursor row and column of the destination virtual display. To move the text to a different position, use the optional **top-left-row2** and **top-left-column2** arguments.

By default, the attributes of the first virtual display are moved and, after the rectangle of text is moved, it is erased from the first virtual display. You can use the **flags** argument to change those default values.

Condition Values Returned

| | |
|------------------|-------------------------------|
| SS\$ _NORMAL | Normal successful completion. |
| SMG\$ _INVCOL | Invalid column number. |
| SMG\$ _INVDIS_ID | Invalid display-id . |
| SMG\$ _INVROW | Invalid row number. |
| SMG\$ _WRONUMARG | Wrong number of arguments. |

SMG\$MOVE_VIRTUAL_DISPLAY

Move Virtual Display

The Move Virtual Display routine relocates a virtual display on a pasteboard and preserves the pasting order.

Format

```
SMG$MOVE_VIRTUAL_DISPLAY display-id ,pasteboard-id ,pasteboard-row  
                        ,pasteboard-column [,top-display-id]
```

Returns

OpenVMS usage: cond_value
type: longword (unsigned)
access: write only
mechanism: by value

Arguments

display-id

OpenVMS usage: identifier
type: longword (unsigned)
access: read only
mechanism: by reference

Specifies the virtual display to be moved. The **display-id** argument is the address of an unsigned longword that contains the display identifier.

The display identifier is returned by SMG\$CREATE_VIRTUAL_DISPLAY.

pasteboard-id

OpenVMS usage: identifier
type: longword (unsigned)
access: read only
mechanism: by reference

Specifies the pasteboard on which the movement is to take place. The **pasteboard-id** argument is the address of an unsigned longword that contains the pasteboard identifier.

The pasteboard identifier is returned by SMG\$CREATE_PASTEBOARD.

pasteboard-row

OpenVMS usage: longword_signed
type: longword (signed)
access: read only
mechanism: by reference

Specifies the row of the pasteboard that is to contain row 1 of the new location of the specified virtual display. The **pasteboard-row** argument is the address of a signed longword that contains the row number.

SMG\$ Routines

SMG\$MOVE_VIRTUAL_DISPLAY

pasteboard-column

OpenVMS usage: longword_signed
type: longword (signed)
access: read only
mechanism: by reference

Specifies the column of the pasteboard that is to contain column 1 of the specified virtual display. The **pasteboard-column** argument is the address of a signed longword that contains the column number.

top-display-id

OpenVMS usage: identifier
type: longword (unsigned)
access: read only
mechanism: by reference

Identifier of the virtual display under which the moving **display-id** will be pasted. The **top-display-id** argument is the address of an unsigned longword containing the specified virtual display identifier. Note that the use of the **top-display-id** argument is only valid when the virtual display specified by **display-id** is not currently pasted and the virtual display specified by **top-display-id** is pasted.

Description

SMG\$MOVE_VIRTUAL_DISPLAY moves a virtual display from its current position to the specified position and, if the virtual display is pasted, preserves the pasting order. If the display being moved is not currently pasted, SMG\$MOVE_VIRTUAL_DISPLAY presents the user with two options. By default, SMG\$MOVE_VIRTUAL_DISPLAY pastes the display at the top of the pasting order in the position specified.

If, however, the optional argument **top-display-id** is specified, SMG\$MOVE_VIRTUAL_DISPLAY pastes the virtual display being moved under the virtual display specified by **top-display-id**. In this case, the virtual display specified by **top-display-id** must already be pasted.

Note that a display cannot be moved from one pasteboard to another. However, the **pasteboard-id** is required because a given virtual display may be pasted to any number of pasteboards.

Do not use this routine if the virtual display is batched.

Condition Values Returned

| | |
|-----------------|--|
| SS\$NORMAL | Normal successful completion. |
| SMG\$_ILLBATFNC | Display is being batched; illegal operation. |
| SMG\$_INVDIS_ID | Invalid display-id . |
| SMG\$_INVPAS_ID | Invalid pasteboard-id . |
| SMG\$_WRONUMARG | Wrong number of arguments. |

Example

Refer to the Fortran example shown in the SMG\$REPASTE_VIRTUAL_DISPLAY routine.

SMG\$NAME_TO_KEYCODE

Translate a Key Name into a Key Code

The Translate a Key Name into a Key Code routine translates the key name of a key on the keyboard into its associated key code.

Format

SMG\$NAME_TO_KEYCODE key-name ,key-code

Returns

OpenVMS usage: cond_value
type: longword (unsigned)
access: write only
mechanism: by value

Arguments

key-name

OpenVMS usage: char_string
type: character string
access: read only
mechanism: by descriptor

String containing the name of the key to be translated into a key code. The **key-name** argument is the address of a descriptor pointing to the character string containing the key name. The **key-name** argument is simply the name of the key (for example, COMMA, PERIOD, KP4, and so forth).

key-code

OpenVMS usage: word_unsigned
type: word (unsigned)
access: write only
mechanism: by reference

Specifies the key code into which **key-name** is to be translated. The **key-code** argument is the address of an unsigned word that contains the key code.

The key code is returned by SMG\$READ_COMPOSED_LINE, SMG\$READ_KEYSTROKE, SMG\$READ_STRING, and SMG\$READ_VERIFY in the **word-terminator-code** argument.

Description

SMG\$NAME_TO_KEYCODE translates the key name of a key on the keyboard into its associated key code. This key code is the same code that is returned by the SMG\$READ_COMPOSED_LINE, SMG\$READ_KEYSTROKE, SMG\$READ_STRING, and SMG\$READ_VERIFY routines in the **word-terminator-code** argument. The form of the key code returned by this routine is SMG\$K_TRM_keyname. For example, if you supply the key name ENTER, the key code returned by this routine is SMG\$K_TRM_ENTER.

For more information on terminator codes, see Table 3-1.

Condition Values Returned

SS\$_NORMAL

Normal successful completion.

SMG\$_INVKEYNAM

Invalid **key-name**.

SMG\$PASTE_VIRTUAL_DISPLAY

Paste Virtual Display

The Paste Virtual Display routine pastes a virtual display to a pasteboard.

Format

```
SMG$PASTE_VIRTUAL_DISPLAY display-id ,pasteboard-id [,pasteboard-row]
                        [,pasteboard-column] [,top-display-id]
```

Returns

OpenVMS usage: cond_value
type: longword (unsigned)
access: write only
mechanism: by value

Arguments

display-id

OpenVMS usage: identifier
type: longword (unsigned)
access: read only
mechanism: by reference

Specifies the virtual display to be pasted. The **display-id** argument is the address of an unsigned longword that contains the display identifier.

The display identifier is returned by SMG\$CREATE_VIRTUAL_DISPLAY.

pasteboard-id

OpenVMS usage: identifier
type: longword (unsigned)
access: read only
mechanism: by reference

Specifies the pasteboard to which the display is to be pasted. The **pasteboard-id** argument is the address of an unsigned longword that contains the pasteboard identifier.

pasteboard-row

OpenVMS usage: longword_signed
type: longword (signed)
access: read only
mechanism: by reference

Specifies the row of the pasteboard that is to contain row 1 of the specified virtual display. The **pasteboard-row** argument is the address of a signed longword that contains the row number.

If **pasteboard-row** is omitted, the last row to which the virtual display was pasted (on any pasteboard) is used. If **pasteboard-row** is omitted and the virtual display was not previously pasted, then row 1 is used.

pasteboard-column

OpenVMS usage: longword_signed
type: longword (signed)
access: read only
mechanism: by reference

Specifies the column of the pasteboard that is to contain column 1 of the specified virtual display. The **pasteboard-column** argument is the address of a signed longword that contains the column number.

If **pasteboard-column** is omitted, the last column to which the virtual display was pasted (on any pasteboard) is used. If **pasteboard-column** is omitted and the virtual display was not previously pasted, then column 1 is used.

top-display-id

OpenVMS usage: identifier
type: longword (unsigned)
access: read only
mechanism: by reference

Identifier of the virtual display under which to paste **display-id**. The optional **top-display-id** argument is the address of an unsigned longword containing this identifier. Note that the virtual display specified by **top-display-id** must already be pasted.

Description

SMG\$PASTE_VIRTUAL_DISPLAY places a display on a pasteboard and makes the display visible, unless the optional argument **top-display-id** is specified. If **top-display-id** is specified, SMG\$PASTE_VIRTUAL_DISPLAY pastes the virtual display being pasted under the virtual display specified by **top-display-id**. In this case, the virtual display specified by **top-display-id** must already be pasted.

Do not use this routine if the virtual display is batched.

Condition Values Returned

| | |
|-----------------|--|
| SS\$_NORMAL | Normal successful completion. |
| SMG\$_ILLBATFNC | Display is being batched; illegal operation. |
| SMG\$_INVDIS_ID | Invalid display-id . |
| SMG\$_INVPAS_ID | Invalid pasteboard-id . |
| SMG\$_WRONUMARG | Wrong number of arguments. |

For an example of how to call SMG\$PASTE_VIRTUAL_DISPLAY, see the Fortran example in the description of SMG\$CREATE_PASTEBOARD.

SMG\$POP_VIRTUAL_DISPLAY

Delete a Series of Virtual Displays

The Delete a Series of Virtual Displays routine deletes a specified virtual display and all displays that were pasted on the specified pasteboard on top of the specified virtual display.

Format

SMG\$POP_VIRTUAL_DISPLAY display-id ,pasteboard-id

Returns

OpenVMS usage: cond_value
type: longword (unsigned)
access: write only
mechanism: by value

Arguments

display-id

OpenVMS usage: identifier
type: longword (unsigned)
access: read only
mechanism: by reference

Specifies the lowest (first) virtual display to be deleted. The **display-id** argument is the address of an unsigned longword that contains the display identifier. All displays that are higher in the pasting order (that is, all displays that were pasted after the specified display) are deleted as well.

The display identifier is returned by SMG\$CREATE_VIRTUAL_DISPLAY.

pasteboard-id

OpenVMS usage: identifier
type: longword (unsigned)
access: read only
mechanism: by reference

Specifies the pasteboard on which the display deletions take place. The **pasteboard-id** argument is the address of an unsigned longword that contains the pasteboard identifier.

Description

SMG\$POP_VIRTUAL_DISPLAY deletes (not merely unpastes) one or more displays from the specified pasteboard, starting with the display specified and including all displays that are higher in the pasting order (that is, all displays that were pasted on top of the specified display).

Condition Values Returned

| | |
|-----------------|--------------------------------|
| SS\$_NORMAL | Normal successful completion. |
| SMG\$_INVDIS_ID | Invalid display-id . |
| SMG\$_INVPAS_ID | Invalid pasteboard-id . |
| SMG\$_WRONUMARG | Wrong number of arguments. |

SMG\$PRINT_PASTEBOARD

Print Pasteboard Using a Print Queue

The Print Pasteboard Using a Print Queue routine prints the contents of the specified pasteboard on a line printer.

Format

SMG\$PRINT_PASTEBOARD pasteboard-id [,queue-name] [,copies] [,form-name]

Returns

OpenVMS usage: cond_value
type: longword (unsigned)
access: write only
mechanism: by value

Arguments

pasteboard-id

OpenVMS usage: identifier
type: longword (unsigned)
access: read only
mechanism: by reference

Identifier of the pasteboard to be printed. The **pasteboard-id** argument is the address of an unsigned longword containing this identifier.

queue-name

OpenVMS usage: char_string
type: character string
access: read only
mechanism: by descriptor

Optional queue name. The **queue-name** argument is the address of a descriptor pointing to the queue name in which to enter the file. The default is SYSSPRINT.

copies

OpenVMS usage: longword_signed
type: longword (signed)
access: read only
mechanism: by reference

Optional number of copies to print. The **copies** argument is the address of a signed longword containing this number. The default and minimum is one copy.

form-name

OpenVMS usage: char_string
type: character string
access: read only
mechanism: by descriptor

Optional name of the form to use when printing. The **form-name** argument is the address of a descriptor pointing to the form name. The default is "DEFAULT".

Description

SMG\$PRINT_PASTEBOARD creates a file and fills it with the contents of the specified pasteboard. Once the file is filled, SMG\$PRINT_PASTEBOARD submits the file to the specified print queue to be printed. If the **queue-name** argument is omitted, the default is SYSS\$PRINT. The file is deleted after printing.

Because the Screen Management Facility cannot determine the type of printer being used, it uses terminal-independent characters (plus sign [+], vertical bar [|], underscore [_], and so forth) for line-drawing characters.

Condition Values Returned

| | |
|-------------|---|
| SS\$_NORMAL | Normal successful completion. |
| SS\$_xxxx | Any error status originating in the \$SNDJBCW system service. |
| LIB\$_xxxx | Any condition value returned by LIB\$ANALYZE_SDESC. |
| SMG\$_xxxx | Any condition value returned by SMG\$PUT_PASTEBOARD. |

SMG\$PUT_CHARS

Write Characters to a Virtual Display

The Write Characters to a Virtual Display routine writes characters in a virtual display with the text you specify.

Format

```
SMG$PUT_CHARS  display-id ,text [,start-row] [,start-column] [,flags] [,rendition-set]
               [,rendition-complement] [,character-set]
```

Returns

OpenVMS usage: cond_value
type: longword (unsigned)
access: write only
mechanism: by value

Arguments

display-id

OpenVMS usage: identifier
type: longword (unsigned)
access: read only
mechanism: by reference

Specifies the virtual display affected. The **display-id** argument is the address of an unsigned longword that contains the display identifier.

The display identifier is returned by SMG\$CREATE_VIRTUAL_DISPLAY.

text

OpenVMS usage: char_string
type: character string
access: read only
mechanism: by descriptor

Characters to be written to the virtual display. The **text** argument is the address of a descriptor pointing to the character string.

start-row

OpenVMS usage: longword_signed
type: longword (signed)
access: read only
mechanism: by reference

Specifies the row at which output begins. If **start-row** is omitted, output begins on the current row. The **start-row** argument is the address of a signed longword that contains the row number.

start-column

OpenVMS usage: longword_signed
type: longword (signed)
access: read only
mechanism: by reference

Specifies the column at which output begins. If **start-column** is omitted, output begins on the current column. The **start-column** argument is the address of a signed longword that contains the column number.

flags

OpenVMS usage: mask_longword
type: longword (unsigned)
access: read only
mechanism: by reference

Optional bit mask that specifies the action to take before the specified text is output. The **flags** argument is the address of an unsigned longword bit mask that contains the flag. The **flags** argument accepts the following values:

| | |
|---------------------|--|
| 0 | Does not erase line (the default). |
| SMG\$M_ERASE_TO_EOL | Erases the remaining part of the line. |
| SMG\$M_ERASE_LINE | Erases the entire line. |

rendition-set

OpenVMS usage: mask_longword
type: longword (unsigned)
access: read only
mechanism: by reference

Attribute specifier. The optional **rendition-set** argument is the address of a longword bit mask in which each attribute set causes the corresponding attribute to be set in the display. The following attributes can be specified using the **rendition-set** argument:

| | |
|---|---|
| SMG\$M_BLINK | Displays blinking characters. |
| SMG\$M_BOLD | Displays characters in higher-than-normal intensity. |
| SMG\$M_REVERSE | Displays characters in reverse video; that is, using the opposite of the default rendition of the virtual display. |
| SMG\$M_UNDERLINE | Displays underlined characters. |
| SMG\$M_INVISIBLE | Specifies invisible characters; that is, the characters exist in the virtual display but do not appear on the pasteboard. |
| SMG\$M_USER1 through SMG\$M_USER8 | Displays user-defined attributes. |

The **display-id** argument must be specified when you use the **rendition-set** argument.

rendition-complement

OpenVMS usage: mask_longword
type: longword (unsigned)
access: read only
mechanism: by reference

Attribute complement specifier. The optional **rendition-complement** argument is the address of a longword bit mask in which each attribute set causes the corresponding attribute to be complemented in the display. All attributes that can be specified with the **rendition-set** argument can be complemented with the **rendition-complement** argument. The **display-id** argument must be specified when you use the **rendition-complement** argument.

SMG\$ Routines

SMG\$PUT_CHARS

The optional arguments **rendition-set** and **rendition-complement** let the user control the attributes of the virtual display. The **rendition-set** argument sets certain virtual display attributes, while **rendition-complement** complements these attributes. If the same bit is specified in both the **rendition-set** and **rendition-complement** parameters, **rendition-set** is evaluated first, followed by **rendition-complement**. By using these two parameters together, the user can control each virtual display attribute in a single procedure call. On a single-attribute basis, the user can cause the following transformations:

| Set | Complement | Action |
|-----|------------|--|
| 0 | 0 | Attribute set to default |
| 1 | 0 | Attribute on |
| 0 | 1 | Attribute set to complement of default setting |
| 1 | 1 | Attribute off |

character-set

OpenVMS usage: longword_unsigned
type: longword (unsigned)
access: read only
mechanism: by reference

Specifies the default character set for all text in this virtual display. The **character-set** argument is the address of an unsigned longword that contains the character set code. Valid values are SMG\$C_ASCII (the default) and SMG\$C_SPEC_GRAPHICS.

Description

SMG\$PUT_CHARS writes text to the specified virtual display, possibly overwriting any existing text. Use SMG\$INSERT_CHARS to write new text while preserving existing text.

By default, SMG\$PUT_CHARS modifies only those character positions where new text is written. However, you can erase the line before the new text is written by specifying SMG\$M_ERASE_LINE for the **flags** argument, or you can erase the remainder of the line after the text is written by specifying SMG\$M_ERASE_TO_EOL for the **flags** argument. The cursor remains at the character position immediately following the last text written. Note that this routine writes to a single line; excess characters at the end of the line are discarded. However, if the display has the SMG\$M_TRUNC_ICON attribute, SMG\$PUT_CHARS outputs the truncation icon when the line overflows the display.

Condition Values Returned

| | |
|----------------|-------------------------------------|
| SS\$NORMAL | Normal successful completion. |
| SMG\$INVCOL | Invalid column. |
| SMG\$INVDIS_ID | Invalid display-id . |
| SMG\$INVROW | Invalid row. |
| SMG\$WILUSERMS | Pasteboard is not a video terminal. |
| SMG\$WRONUMARG | Wrong number of arguments. |
| LIB\$INVSTRDES | Invalid string descriptor. |

Example

```

C+
C This Fortran example program demonstrates the use of
C SMG$PUT_CHARS.
C-

      INTEGER SMG$CREATE_VIRTUAL_DISPLAY, SMG$CREATE_PASTEBOARD
      INTEGER SMG$PASTE_VIRTUAL_DISPLAY, SMG$PUT_CHARS
      INTEGER DISPLAY1, PASTE1, ROWS, COLUMNS, BORDER, STATUS

C+
C Create the virtual display. To give it a border, set BORDER = 1.
C No border would be BORDER = 0.
C-
      ROWS = 7
      COLUMNS = 50
      BORDER = 1

      STATUS = SMG$CREATE_VIRTUAL_DISPLAY
1      (ROWS, COLUMNS, DISPLAY1, BORDER)
      IF (.NOT. STATUS) CALL LIB$SIGNAL(%VAL(STATUS))

C+
C Create the pasteboard.
C-
      STATUS = SMG$CREATE_PASTEBOARD (PASTE1)
      IF (.NOT. STATUS) CALL LIB$SIGNAL(%VAL(STATUS))

C+
C Put data in the virtual display.
C-
      STATUS = SMG$PUT_CHARS ( DISPLAY1,
1      ' This virtual display has 7 rows and 50 columns.', 2, 1 )
      IF (.NOT. STATUS) CALL LIB$SIGNAL(%VAL(STATUS))

      STATUS = SMG$PUT_CHARS ( DISPLAY1,
1      ' This is a bordered virtual display.', 4, 1 )
      IF (.NOT. STATUS) CALL LIB$SIGNAL(%VAL(STATUS))

      STATUS = SMG$PUT_CHARS ( DISPLAY1,
1      ' SMG$PUT_CHARS puts data in this virtual display.', 6, 1 )
      IF (.NOT. STATUS) CALL LIB$SIGNAL(%VAL(STATUS))

C+
C Paste the virtual display.
C-
      STATUS = SMG$PASTE_VIRTUAL_DISPLAY ( DISPLAY1, PASTE1, 4, 15 )
      IF (.NOT. STATUS) CALL LIB$SIGNAL(%VAL(STATUS))

      END

```

SMG\$ Routines
SMG\$PUT_CHARS

The output generated by this Fortran program is shown in Figure SMG-33.

Figure SMG-33 Output of Fortran Program Calling SMG\$PUT_CHARS

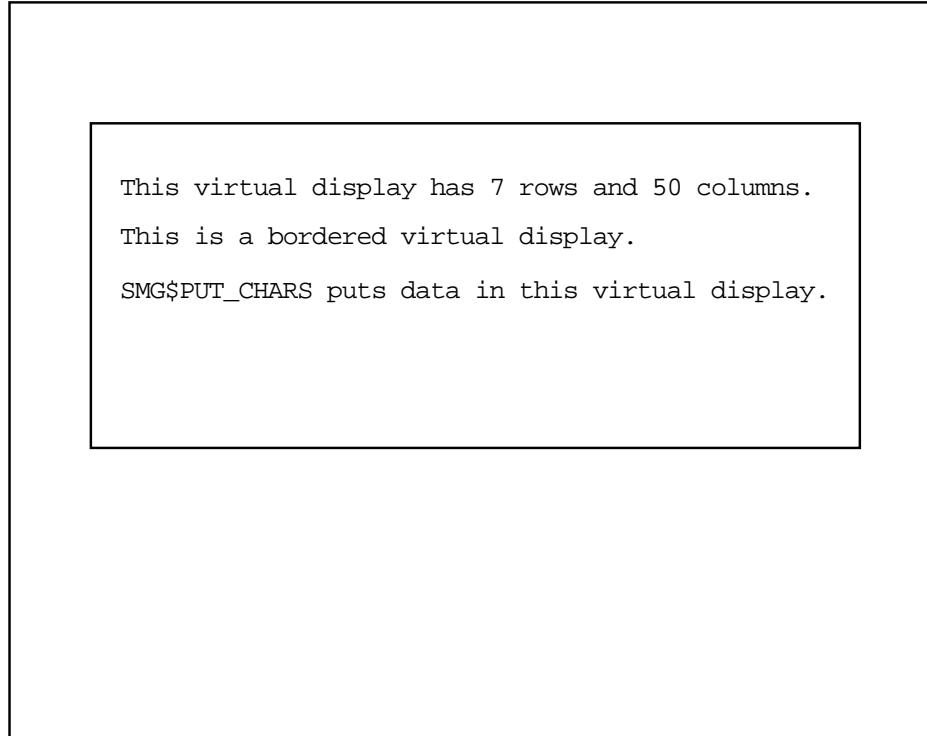

ZK-4116-GE

SMG\$PUT_CHARS_HIGHWIDE

Write Double-Height Double-Width Characters

The Write Double-Height Double-Width Characters routine writes double-height, double-width (highwide) characters to a virtual display.

Format

```
SMG$PUT_CHARS_HIGHWIDE display-id ,text [,start-row] [,start-column]
                        [,rendition-set] [,rendition-complement]
                        [,character-set]
```

Returns

OpenVMS usage: cond_value
type: longword (unsigned)
access: write only
mechanism: by value

Arguments

display-id

OpenVMS usage: identifier
type: longword (unsigned)
access: read only
mechanism: by reference

Specifies the virtual display affected. The **display-id** argument is the address of an unsigned longword that contains the display identifier.

The display identifier is returned by SMG\$CREATE_VIRTUAL_DISPLAY.

text

OpenVMS usage: char_string
type: character string
access: read only
mechanism: by descriptor

Characters to be written to the virtual display. The **text** argument is the address of a descriptor pointing to the text.

start-row

OpenVMS usage: longword_signed
type: longword (signed)
access: read only
mechanism: by reference

Specifies the line at which output begins. The **start-row** argument is the address of a signed longword that contains the line number. If **start-row** is omitted or if it is equal to zero, output begins on the current line.

SMG\$ Routines

SMG\$PUT_CHARS_HIGHWIDE

start-column

OpenVMS usage: longword_signed
type: longword (signed)
access: read only
mechanism: by reference

Specifies the column at which output begins. The **start-column** argument is the address of a signed longword that contains the column number. If **start-column** is omitted or if it is equal to zero, output begins on the current column.

rendition-set

OpenVMS usage: mask_longword
type: longword (unsigned)
access: read only
mechanism: by reference

Attribute specifier. The optional **rendition-set** argument is the address of a longword bit mask in which each attribute set causes the corresponding attribute to be set in the display. The following attributes can be specified using the **rendition-set** argument:

| | |
|---|---|
| SMG\$M_BLINK | Displays blinking characters. |
| SMG\$M_BOLD | Displays characters in higher-than-normal intensity. |
| SMG\$M_REVERSE | Displays characters in reverse video; that is, using the opposite of the default rendition of the virtual display. |
| SMG\$M_UNDERLINE | Displays underlined characters. |
| SMG\$M_INVISIBLE | Specifies invisible characters; that is, the characters exist in the virtual display but do not appear on the pasteboard. |
| SMG\$M_USER1 through SMG\$M_USER8 | Displays user-defined attributes. |

The **display-id** argument must be specified when you use the **rendition-set** argument.

rendition-complement

OpenVMS usage: mask_longword
type: longword (unsigned)
access: read only
mechanism: by reference

Attribute complement specifier. The optional **rendition-complement** argument is the address of a longword bit mask in which each attribute set causes the corresponding attribute to be complemented in the display. All attributes that can be specified with the **rendition-set** argument can be complemented with the **rendition-complement** argument. The **display-id** argument must be specified when you use the **rendition-complement** argument.

The optional arguments **rendition-set** and **rendition-complement** let the user control the attributes of the virtual display. The **rendition-set** argument sets certain virtual display attributes, while **rendition-complement** complements these attributes. If the same bit is specified in both the **rendition-set** and **rendition-complement** parameters, **rendition-set** is evaluated first, followed by **rendition-complement**. By using these two parameters together, the

user can control each virtual display attribute in a single procedure call. On a single-attribute basis, the user can cause the following transformations:

| Set | Complement | Action |
|-----|------------|--|
| 0 | 0 | Attribute set to default |
| 1 | 0 | Attribute on |
| 0 | 1 | Attribute set to complement of default setting |
| 1 | 1 | Attribute off |

character-set

OpenVMS usage: longword_unsigned
 type: longword (unsigned)
 access: read only
 mechanism: by reference

Specifies the default character set for all text in this virtual display. The **character-set** argument is the address of an unsigned longword that contains the character set code. Valid values are SMG\$C_ASCII (the default) and SMG\$C_SPEC_GRAPHICS.

Description

SMG\$PUT_CHARS_HIGHWIDE writes double-height, double-width characters to the specified virtual display. The corresponding pasteboard line cannot contain a mixture of single-height/width and double-height/width characters; if the line contains any single-height/width characters, those characters will be replaced with blanks. If the text does not span the line, it is padded with blanks. The virtual cursor remains at the character position immediately following the last text written.

Note that if the terminal does not support double-height characters, the same characters will be displayed on two successive lines.

If the display has the SMG\$M_TRUNC_ICON attribute, SMG\$PUT_CHAR_HIGHWIDE outputs the truncation icon when the line overflows the display.

Condition Values Returned

| | |
|----------------|-------------------------------------|
| SS\$NORMAL | Normal successful completion. |
| SMG\$INVCOL | Invalid column. |
| SMG\$INVDIS_ID | Invalid display-id . |
| SMG\$INVROW | Invalid row. |
| SMG\$WILUSERMS | Pasteboard is not a video terminal. |
| SMG\$WRONUMARG | Wrong number of arguments. |
| LIB\$INVSTRDES | Invalid string descriptor. |

SMG\$PUT_CHARS_MULTI

Put Text with Multiple Renditions to Display

The Put Text with Multiple Renditions to Display routine writes text with multiple renditions to the virtual display.

Format

```
SMG$PUT_CHARS_MULTI  display-id ,text [,start-row] [,start-column]
                    [,flags] [,rendition-string] [,rendition-complement]
                    [,character-set]
```

Returns

OpenVMS usage: cond_value
type: longword (unsigned)
access: write only
mechanism: by value

Arguments

display-id

OpenVMS usage: identifier
type: longword (unsigned)
access: read only
mechanism: by reference

Identifier of the virtual display to be affected. The **display-id** argument is the address of an unsigned longword that contains this identifier.

text

OpenVMS usage: char_string
type: character string
access: read only
mechanism: by descriptor

Text to be output. The **text** argument is the address of a descriptor pointing to the output string.

start-row

OpenVMS usage: longword_signed
type: longword (signed)
access: read only
mechanism: by reference

Optional row number at which to start output. The **start-row** argument is the address of a signed longword containing this number. If omitted, the current row number is used.

start-column

OpenVMS usage: longword_signed
 type: longword (signed)
 access: read only
 mechanism: by reference

Optional column number at which to start output. The **start-column** argument is the address of a signed longword containing this number. If omitted, the current column number is used.

flags

OpenVMS usage: mask_longword
 type: longword (unsigned)
 access: read only
 mechanism: by reference

Optional bit mask that specifies the action to take before the specified text is output. The **flags** argument is the address of an unsigned longword that contains the flag. The **flags** argument accepts the following values:

- 0 Does not erase line (the default).
- SMG\$M_ERASE_TO_EOL Erases the remaining part of the line.
- SMG\$M_ERASE_LINE Erases the entire line.

rendition-string

OpenVMS usage: char_string
 type: character string
 access: read only
 mechanism: by descriptor

Optional bit mask string that controls the video attributes. The **rendition-string** argument is the address of a descriptor pointing to the bit mask string. Each attribute set causes the corresponding attribute to be set for the corresponding byte in the text string in the display. The following attributes can be specified for each byte using the **rendition-string** argument:

- SMG\$M_BLINK Displays blinking characters.
- SMG\$M_BOLD Displays characters in higher-than-normal intensity.
- SMG\$M_REVERSE Displays characters in reverse video; that is, using the opposite of the default rendition of the virtual display.
- SMG\$M_UNDERLINE Displays underlined characters.
- SMG\$M_INVISIBLE Specifies invisible characters; that is, the characters exist in the virtual display but do not appear on the pasteboard.

rendition-complement

OpenVMS usage: char_string
 type: character string
 access: read only
 mechanism: by descriptor

Optional bit mask string that controls the video attributes. The **rendition-complement** is the address of a descriptor pointing to the bit mask string. Each attribute set causes the corresponding attribute to be complemented for the corresponding byte in the text string in the display.

SMG\$ Routines

SMG\$PUT_CHARS_MULTI

If the same bit in the same byte is specified in both the **rendition-string** and **rendition-complement** arguments, **rendition-string** is evaluated first, followed by **rendition-complement**. By using these two parameters together, you can independently control each attribute in a single routine call. On a single-attribute basis, you can cause the following transformations:

| Set | Complement | Action |
|-----|------------|--|
| 0 | 0 | Attribute set to default |
| 1 | 0 | Attribute on |
| 0 | 1 | Attribute set to complement of default setting |
| 1 | 1 | Attribute off |

character-set

OpenVMS usage: longword_unsigned
type: longword (unsigned)
access: read only
mechanism: by reference

Specifies the default character set for all text in this virtual display. The **character-set** argument is the address of an unsigned longword that contains the character set code. Valid values are SMG\$C_ASCII (the default) and SMG\$C_SPEC_GRAPHICS.

Description

SMG\$PUT_CHARS_MULTI lets you write text with multiple renditions to the virtual display. No additional cursor movement sequences are added. SMG\$PUT_CHARS_MULTI overwrites any existing text in the positions you specify. Use SMG\$INSERT_CHARS to write new text while preserving existing text.

By default, SMG\$PUT_CHARS_MULTI modifies only those character positions where new text is written. However, you can erase the line before the new text is written by specifying SMG\$M_ERASE_LINE for the **flags** argument, or you can erase the remainder of the line after the text is written by specifying SMG\$M_ERASE_TO_EOL for the **flags** argument. The cursor remains at the character position immediately following the last text written. Note that this routine writes to a single line; excess characters at the end of the line are discarded. However, if the display has the SMG\$M_TRUNC_ICON attribute, SMG\$PUT_CHARS_MULTI outputs the truncation icon when the line overflows the display.

Condition Values Returned

| | |
|-----------------|---|
| SS\$NORMAL | Normal successful completion. |
| SMG\$_INVCOL | Invalid column specification. |
| SMG\$_INVROW | Invalid row specification. |
| SMG\$_WILUSERMS | Pasteboard is not a video terminal. |
| SMG\$_WRONUMARG | Wrong number (or combination of) arguments. |
| LIB\$_INVSTRDES | Invalid string descriptor. |

SMG\$PUT_CHARS_WIDE

Write Double-Width Characters

The Write Double-Width Characters routine writes double-width characters to a virtual display.

Format

```
SMG$PUT_CHARS_WIDE  display-id ,text [,start-row] [,start-column] [,rendition-set]
                    [,rendition-complement] [,character-set]
```

Returns

OpenVMS usage: cond_value
 type: longword (unsigned)
 access: write only
 mechanism: by value

Arguments

display-id

OpenVMS usage: identifier
 type: longword (unsigned)
 access: read only
 mechanism: by reference

Specifies the virtual display affected. The **display-id** argument is the address of an unsigned longword that contains the display identifier.

The display identifier is returned by SMG\$CREATE_VIRTUAL_DISPLAY.

text

OpenVMS usage: char_string
 type: character string
 access: read only
 mechanism: by descriptor

Characters to be written to the virtual display. The **text** argument is the address of a descriptor pointing to the text.

start-row

OpenVMS usage: longword_signed
 type: longword (signed)
 access: read only
 mechanism: by reference

Specifies the line at which output begins. The **start-row** argument is the address of a signed longword that contains the line number. If **start-row** is omitted, output begins on the current line.

start-column

OpenVMS usage: longword_signed
 type: longword (signed)
 access: read only
 mechanism: by reference

SMG\$ Routines

SMG\$PUT_CHARS_WIDE

Specifies the column at which output begins. If **start-column** is omitted, output begins on the current column. The **start-column** argument is the address of a signed longword that contains the column number.

rendition-set

OpenVMS usage: mask_longword
type: longword (unsigned)
access: read only
mechanism: by reference

Attribute specifier. The optional **rendition-set** argument is the address of a longword bit mask in which each attribute set causes the corresponding attribute to be set in the display. The following attributes can be specified using the **rendition-set** argument:

| | |
|---|---|
| SMG\$M_BLINK | Displays blinking characters. |
| SMG\$M_BOLD | Displays characters in higher-than-normal intensity. |
| SMG\$M_REVERSE | Displays characters in reverse video; that is, using the opposite of the default rendition of the virtual display. |
| SMG\$M_UNDERLINE | Displays underlined characters. |
| SMG\$M_INVISIBLE | Specifies invisible characters; that is, the characters exist in the virtual display but do not appear on the pasteboard. |
| SMG\$M_USER1 through SMG\$M_USER8 | Displays user-defined attributes. |

The **display-id** argument must be specified when you use the **rendition-set** argument.

rendition-complement

OpenVMS usage: mask_longword
type: longword (unsigned)
access: read only
mechanism: by reference

Attribute complement specifier. The optional **rendition-complement** argument is the address of a longword bit mask in which each attribute set causes the corresponding attribute to be complemented in the display. All attributes that can be specified with the **rendition-set** argument can be complemented with the **rendition-complement** argument. The **display-id** argument must be specified when you use the **rendition-complement** argument.

The optional arguments **rendition-set** and **rendition-complement** let the user control the attributes of the virtual display. The **rendition-set** argument sets certain virtual display attributes, while **rendition-complement** complements these attributes. If the same bit is specified in both the **rendition-set** and **rendition-complement** parameters, **rendition-set** is evaluated first, followed by **rendition-complement**. By using these two parameters together, the user can control each virtual display attribute in a single procedure call. On a single-attribute basis, the user can cause the following transformations:

| Set | Complement | Action |
|-----|------------|--|
| 0 | 0 | Attribute set to default |
| 1 | 0 | Attribute on |
| 0 | 1 | Attribute set to complement of default setting |
| 1 | 1 | Attribute off |

character-set

OpenVMS usage: mask_longword
 type: longword (unsigned)
 access: read only
 mechanism: by reference

Specifies the default character set for all text in this virtual display. The **character-set** argument is the address of an unsigned longword that contains the character set code. Valid values are SMG\$C_ASCII (the default) and SMG\$C_SPEC_GRAPHICS.

Description

SMG\$PUT_CHARS_WIDE writes double-width text to the specified virtual display, possibly overwriting any existing text. The line cannot contain a mixture of single- and double-width characters; if the line previously contained any single-width characters, those characters are replaced with blanks. The virtual cursor is left at the first character position following the text written.

If the display has the SMG\$M_TRUNC_ICON attribute, SMG\$PUT_CHARS_WIDE outputs the truncation icon when the line overflows the display.

Condition Values Returned

| | |
|----------------|-------------------------------------|
| SS\$NORMAL | Normal successful completion. |
| SMG\$INVCOL | Invalid column. |
| SMG\$INVDIS_ID | Invalid display-id . |
| SMG\$INVROW | Invalid row. |
| SMG\$WILUSERMS | Pasteboard is not a video terminal. |
| SMG\$WRONUMARG | Wrong number of arguments. |
| LIB\$INVSTRDES | Invalid string descriptor. |

SMG\$PUT_HELP_TEXT

Output Help Text to the Display

The Output Help Text to the Display routine retrieves and outputs the help text for the specified topic in the virtual display provided.

Format

```
SMG$PUT_HELP_TEXT  display-id [,keyboard-id] [,help-topic] [,help-library]
                   [,rendition-set] [,rendition-complement]
```

Returns

OpenVMS usage: cond_value
type: longword (unsigned)
access: write only
mechanism: by value

Arguments

display-id

OpenVMS usage: identifier
type: longword (unsigned)
access: read only
mechanism: by reference

Display identifier of the virtual display to which the help text is written. The **display-id** argument is the address of an unsigned longword that contains this virtual display identifier. Note that this display must be paged and cannot be occluded or batched.

keyboard-id

OpenVMS usage: identifier
type: longword (unsigned)
access: read only
mechanism: by reference

Optional keyboard identifier of the virtual keyboard used for input. The **keyboard-id** argument is the address of an unsigned longword that contains this virtual keyboard identifier. If the **keyboard-id** parameter is not specified, prompting is disabled.

help-topic

OpenVMS usage: char_string
type: character string
access: read only
mechanism: by descriptor

Optional help topic. The **help-topic** argument is the address of a descriptor pointing to the help topic string.

help-library

OpenVMS usage: char_string
type: character string
access: read only
mechanism: by descriptor

Optional help library name. The **help-library** argument is the address of a descriptor pointing to the help library name. The default is SYSSHELP:HELPLIB.HLB.

rendition-set

OpenVMS usage: mask_longword
type: longword (unsigned)
access: read only
mechanism: by reference

Attribute specifier. The optional **rendition-set** argument is the address of a longword bit mask in which each attribute set causes the corresponding attribute to be set in the display. The following attributes can be specified using the **rendition-set** argument:

| | |
|---|---|
| SMG\$M_BLINK | Displays blinking characters. |
| SMG\$M_BOLD | Displays characters in higher-than-normal intensity. |
| SMG\$M_REVERSE | Displays characters in reverse video; that is, using the opposite of the default rendition of the virtual display. |
| SMG\$M_UNDERLINE | Displays underlined characters. |
| SMG\$M_INVISIBLE | Specifies invisible characters; that is, the characters exist in the virtual display but do not appear on the pasteboard. |
| SMG\$M_USER1 through SMG\$M_USER8 | Displays user-defined attributes. |

The **display-id** argument must be specified when you use the **rendition-set** argument.

rendition-complement

OpenVMS usage: mask_longword
type: longword (unsigned)
access: read only
mechanism: by reference

Attribute complement specifier. The optional **rendition-complement** argument is the address of a longword bit mask in which each attribute set causes the corresponding attribute to be complemented in the display. All attributes that can be specified with the **rendition-set** argument can be complemented with the **rendition-complement** argument. The **display-id** argument must be specified when you use the **rendition-complement** argument.

The optional arguments **rendition-set** and **rendition-complement** let the user control the attributes of the virtual display. The **rendition-set** argument sets certain virtual display attributes, while **rendition-complement** complements these attributes. If the same bit is specified in both the **rendition-set** and **rendition-complement** parameters, **rendition-set** is evaluated first, followed by **rendition-complement**. By using these two parameters together, the

SMG\$ Routines

SMG\$PUT_HELP_TEXT

user can control each virtual display attribute in a single procedure call. On a single-attribute basis, the user can cause the following transformations:

| Set | Complement | Action |
|-----|------------|--|
| 0 | 0 | Attribute set to default |
| 1 | 0 | Attribute on |
| 0 | 1 | Attribute set to complement of default setting |
| 1 | 1 | Attribute off |

Description

SMG\$PUT_HELP_TEXT lets you retrieve and output help text for a specified topic in the virtual display specified. The text is output to the virtual display's scrolling region. If you specify the **keyboard-id** argument, you are prompted for input when the last line of the virtual scrolling region is reached. In response to this prompt you can either press the Return key to continue the display, or enter a new topic to receive help on. Note that the virtual display specified by **display-id** cannot be batched or contain a viewport. If the **keyboard-id** argument is specified, the virtual display cannot be occluded and must contain at least three rows.

Condition Values Returned

| | |
|-----------------|--|
| SS\$_NORMAL | Normal successful completion. |
| SMG\$_ILLBATFNC | The virtual display or pasteboard was batched. |
| SMG\$_INVDIS_ID | The display-id is illegal, has an associated viewport, or is occluded. |
| SMG\$_NOTPASTED | The virtual display specified by display-id is not pasted. |
| SMG\$_xxxx | Any condition value returned by SMG\$SET_CURSOR_ABS or SMG\$CHECK_FOR_OCCLUSION. |
| LIB\$_xxxx | Any condition value returned by LIB\$FIND_IMAGE_SYMBOL. |
| LBR\$_xxxx | Any condition value returned by LBR\$OUTPUT_HELP. |

SMG\$PUT_LINE

Write Line to Virtual Display

The Write Line to Virtual Display routine writes a line of text to a virtual display, beginning at the current virtual cursor position.

Format

SMG\$PUT_LINE display-id ,text [,line-advance] [,rendition-set]
[,rendition-complement] [,flags] [,character-set] [,direction]

Returns

OpenVMS usage: cond_value
type: longword (unsigned)
access: write only
mechanism: by value

Arguments

display-id

OpenVMS usage: identifier
type: longword (unsigned)
access: read only
mechanism: by reference

Specifies the virtual display affected. The **display-id** argument is the address of an unsigned longword that contains the display identifier.

The display identifier is returned by SMG\$CREATE_VIRTUAL_DISPLAY.

text

OpenVMS usage: char_string
type: character string
access: read only
mechanism: by descriptor

The characters to be written to the virtual display. The **text** argument is the address of a descriptor pointing to the text.

line-advance

OpenVMS usage: longword_signed
type: longword (signed)
access: read only
mechanism: by reference

Specifies the number of lines to advance after output. The **line-advance** argument is the address of a signed longword that contains the number of lines to advance. The default is 1. If you specify 0 for **line-advance**, SMG\$PUT_LINE overwrites any existing text.

SMG\$ Routines

SMG\$PUT_LINE

rendition-set

OpenVMS usage: mask_longword
type: longword (unsigned)
access: read only
mechanism: by reference

Attribute specifier. The optional **rendition-set** argument is the address of a longword bit mask in which each attribute set causes the corresponding attribute to be set in the display. The following attributes can be specified using the **rendition-set** argument:

| | |
|---|---|
| SMG\$M_BLINK | Displays blinking characters. |
| SMG\$M_BOLD | Displays characters in higher-than-normal intensity. |
| SMG\$M_REVERSE | Displays characters in reverse video; that is, using the opposite of the default rendition of the virtual display. |
| SMG\$M_UNDERLINE | Displays underlined characters. |
| SMG\$M_INVISIBLE | Specifies invisible characters; that is, the characters exist in the virtual display but do not appear on the pasteboard. |
| SMG\$M_USER1 through SMG\$M_USER8 | Displays user-defined attributes. |

The **display-id** argument must be specified when you use the **rendition-set** argument.

rendition-complement

OpenVMS usage: mask_longword
type: longword (unsigned)
access: read only
mechanism: by reference

Attribute complement specifier. The optional **rendition-complement** argument is the address of a longword bit mask in which each attribute set causes the corresponding attribute to be complemented in the display. All attributes that can be specified with the **rendition-set** argument can be complemented with the **rendition-complement** argument. The **display-id** argument must be specified when you use the **rendition-complement** argument.

The optional arguments **rendition-set** and **rendition-complement** let the user control the attributes of the virtual display. The **rendition-set** argument sets certain virtual display attributes, while **rendition-complement** complements these attributes. If the same bit is specified in both the **rendition-set** and **rendition-complement** parameters, **rendition-set** is evaluated first, followed by **rendition-complement**. By using these two parameters together, the user can control each virtual display attribute in a single procedure call. On a single-attribute basis, the user can cause the following transformations:

| Set | Complement | Action |
|-----|------------|--|
| 0 | 0 | Attribute set to default |
| 1 | 0 | Attribute on |
| 0 | 1 | Attribute set to complement of default setting |

| Set | Complement | Action |
|-----|------------|---------------|
| 1 | 1 | Attribute off |

flags

OpenVMS usage: mask_longword
 type: longword (unsigned)
 access: read only
 mechanism: by reference

Optional bit mask that specifies the action to be taken if the text does not fit on the line. The **flags** argument is the address of an unsigned longword that contains the flag. The **flags** argument accepts the following values:

0 Does not wrap (default).
 SMG\$M_WRAP_CHAR Wraps at the last character on the line.
 SMG\$M_WRAP_WORD Wraps at the last space on the line.

character-set

OpenVMS usage: longword_unsigned
 type: longword (unsigned)
 access: read only
 mechanism: by reference

Specifies the default character set for all text in this virtual display. The **character-set** argument is the address of an unsigned longword that contains the character set code. Valid values are SMG\$C_ASCII (default) and SMG\$C_SPEC_GRAPHICS.

direction

OpenVMS usage: mask_longword
 type: longword (unsigned)
 access: read only
 mechanism: by reference

Specifies the direction to scroll, if scrolling is necessary. The **direction** argument is the address of a longword bit mask that contains the direction code. Valid values are SMG\$M_UP (default) and SMG\$M_DOWN.

Description

SMG\$PUT_LINE writes lines of text to the virtual display, beginning at the current line. Once text reaches the bottom or top line (depending on the scrolling direction), subsequent calls to this routine cause the display to scroll. SMG\$PUT_LINE writes out the entire line, starting at the current virtual cursor position. If the caller's text does not span the entire line, the line is padded with blanks.

If **flags** specifies wrapping, lines are scrolled **line-advance** times to make room for the overflow characters in the "next" line. The "next" line is determined by the scrolling **direction**. If **flags** does not specify wrapping, excess characters are discarded.

Following a call to SMG\$PUT_LINE, the virtual cursor position is set to column 1 of the next line where output should occur. The next line where output should occur is determined by the **line-advance** and **direction** arguments; **line-advance** defaults to 1 so that subsequent calls to SMG\$PUT_LINE do not cause overprinting.

SMG\$ Routines

SMG\$PUT_LINE

Other SMG\$ procedures that can be used to write lines of text to a virtual display are SMG\$PUT_LINE_WIDE, SMG\$PUT_LINE_HIGHWIDE, SMG\$PUT_LINE_MULTI, and SMG\$INSERT_LINE.

Condition Values Returned

| | |
|----------------|-------------------------------------|
| SS\$NORMAL | Normal successful completion. |
| SMG\$INVDIS_ID | Invalid display-id . |
| SMG\$WILUSERMS | Pasteboard is not a video terminal. |
| SMG\$WRONUMARG | Wrong number of arguments. |
| LIB\$INVSTRDES | Invalid string descriptor. |

Examples

```
1. C+
   C This Fortran example program demonstrates the use of SMG$PUT_LINE.
   C-

   C+
   C Include the SMG definitions. In particular, we want SMG$M_BORDER and
   C SMG$M_UNDERLINE.
   C-

       IMPLICIT INTEGER (A-Z)
       INCLUDE '($SMGDEF)'
       CHARACTER*30 TEXT(3)

   C+
   C Create a virtual display with a border.
   C-

       ROWS = 7
       COLUMNS = 50

       STATUS = SMG$CREATE_VIRTUAL_DISPLAY
1      (ROWS, COLUMNS, DISPLAY1, SMG$M_BORDER)
       IF (.NOT. STATUS) CALL LIB$SIGNAL(%VAL(STATUS))

   C+
   C Create the pasteboard.
   C-

       STATUS = SMG$CREATE_PASTEBOARD (PASTE1)
       IF (.NOT. STATUS) CALL LIB$SIGNAL(%VAL(STATUS))

   C+
   C Put data in the virtual display.
   C-

       TEXT(1) = 'This virtual display has 7'
       TEXT(2) = 'rows and 50 columns.'
       TEXT(3) = 'Text entered by SMG$PUT_LINE.'

   C+
   C After the first line of text is printed, call SMG$PUT_LINE to
   C advance two lines.
   C-

       STATUS = SMG$PUT_LINE ( DISPLAY1, TEXT(1), 2 )
       IF (.NOT. STATUS) CALL LIB$SIGNAL(%VAL(STATUS))
```

SMG\$ Routines SMG\$PUT_LINE

```
C+
C Now, use SMG$PUT_LINE to underline the next line of text.
C Notice that 30 characters are being underlined. Advance one
C line of text after displaying the line.
C-
        STATUS = SMG$PUT_LINE ( DISPLAY1, TEXT(2), 1, SMG$M_UNDERLINE )
        IF (.NOT. STATUS) CALL LIB$SIGNAL(%VAL(STATUS))

C+
C Display the third line of text.
C-
        STATUS = SMG$PUT_LINE ( DISPLAY1, TEXT(3) )
        IF (.NOT. STATUS) CALL LIB$SIGNAL(%VAL(STATUS))

C+
C Paste the virtual display.
C-
        STATUS = SMG$PASTE_VIRTUAL_DISPLAY ( DISPLAY1, PASTE1, 4, 15 )
        IF (.NOT. STATUS) CALL LIB$SIGNAL(%VAL(STATUS))

        END
```

The output generated by this Fortran program is shown in Figure SMG-34.

Figure SMG-34 Output Generated by Fortran Program Calling SMG\$PUT_LINE

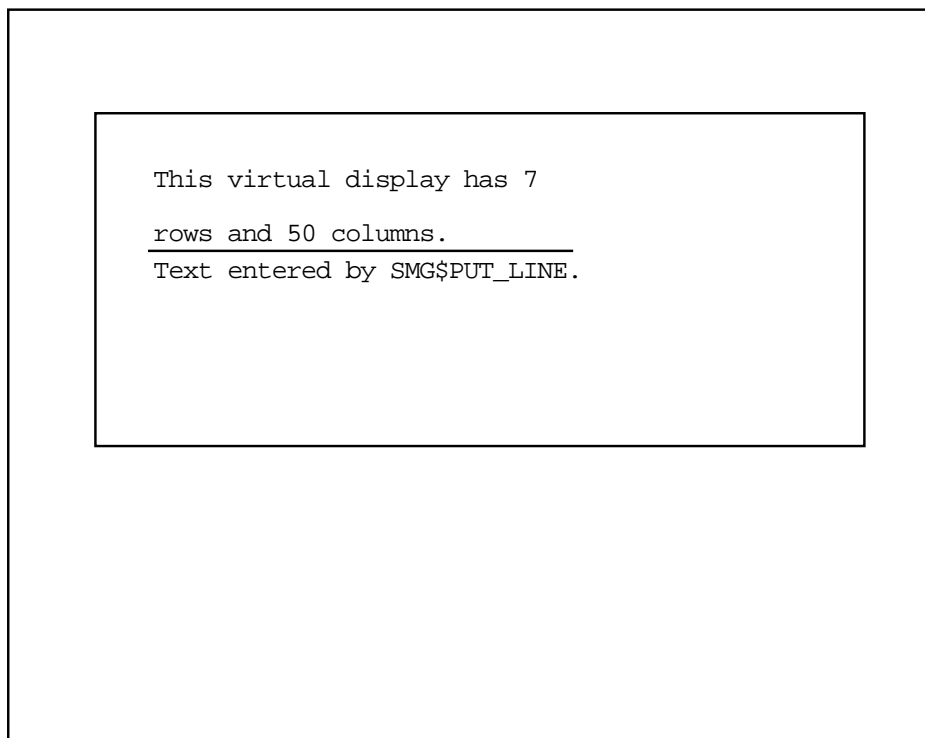

```
This virtual display has 7
rows and 50 columns.
Text entered by SMG$PUT_LINE.
```

ZK-4135-GE

SMG\$ Routines

SMG\$PUT_LINE

This program uses the **direction** argument to SMG\$PUT_LINE:

```
2. C+
C This Fortran example program demonstrates the use of the DIRECTION
C argument in the SMG$PUT_LINE routine.
C-
      INCLUDE '$SMGDEF'
      IMPLICIT INTEGER*4 (A-Z)

C+
C Call SMG$CREATE_PASTEBOARD to establish the terminal screen
C as a pasteboard.
C-
      STATUS = SMG$CREATE_PASTEBOARD (NEW_PID)
      IF (.NOT. STATUS) CALL LIB$STOP(%VAL(STATUS))

C+
C Call SMG$CREATE_VIRTUAL_DISPLAY to establish a virtual display region.
C-
      STATUS = SMG$CREATE_VIRTUAL_DISPLAY (5,80,DISPLAY_ID)
      IF (.NOT. STATUS) CALL LIB$STOP(%VAL(STATUS))

C+
C Paste the virtual display to the screen, starting at
C row 10, column 15, by calling SMG$PASTE_VIRTUAL_DISPLAY.
C-
      STATUS = SMG$PASTE_VIRTUAL_DISPLAY(DISPLAY_ID,NEW_PID,10,15)
      IF (.NOT. STATUS) CALL LIB$STOP(%VAL(STATUS))

C+
C Define a scrolling region by calling SMG$SET_DISPLAY_SCROLL_REGION.
C-
      STATUS = SMG$SET_DISPLAY_SCROLL_REGION(DISPLAY_ID,1,5)
      IF (.NOT. STATUS) CALL LIB$STOP(%VAL(STATUS))

C+
C Call SMG$PUT_LINE and SMG$ERASE_LINE to write three scrolling lines
C to the screen: underlined, blinking, and reverse video.
C-
      DO I = 1,10
      IF ((I/2) + (I/2) .EQ. I) THEN
          DIR = SMG$M_UP
      ELSE
          DIR = SMG$M_DOWN
      ENDIF

      STATUS = SMG$PUT_LINE (DISPLAY_ID,
1      'This line is underlined',,SMG$M_UNDERLINE,,,DIR)
      IF (.NOT. STATUS) CALL LIB$STOP(%VAL(STATUS))

      STATUS = SMG$ERASE_LINE(DISPLAY_ID)
      IF (.NOT. STATUS) CALL LIB$STOP(%VAL(STATUS))

      STATUS = SMG$PUT_LINE (DISPLAY_ID,'This line is blinking', ,
1      SMG$M_BLINK,,,DIR)
      IF (.NOT. STATUS) CALL LIB$STOP(%VAL(STATUS))

      STATUS = SMG$ERASE_LINE (DISPLAY_ID)
      IF (.NOT. STATUS) CALL LIB$STOP(%VAL(STATUS))

      STATUS = SMG$PUT_LINE (DISPLAY_ID,'This line is reverse
1      video',,SMG$M_REVERSE,,,DIR)
      IF (.NOT. STATUS) CALL LIB$STOP(%VAL(STATUS))

      STATUS = SMG$ERASE_LINE (DISPLAY_ID)
      IF (.NOT. STATUS) CALL LIB$STOP(%VAL(STATUS))
      ENDDO
      END
```

SMG\$PUT_LINE_HIGHWIDE

Write Double-Height and Double-Width Line

The Write Double-Height and Double-Width Line routine writes a line of text with double-height and double-width (highwide) characters.

Format

```
SMG$PUT_LINE_HIGHWIDE  display-id ,text [,line-advance] [,rendition-set]
                        [,rendition-complement] [,flags] [,character-set]
```

Returns

OpenVMS usage: cond_value
 type: longword (unsigned)
 access: write only
 mechanism: by value

Arguments

display-id

OpenVMS usage: identifier
 type: longword (unsigned)
 access: read only
 mechanism: by reference

Display identifier. The **display-id** argument is the address of an unsigned longword that contains the display identifier of the virtual display.

text

OpenVMS usage: char_string
 type: character string
 access: read only
 mechanism: by descriptor

Text to be output. The **text** argument is the address of the descriptor pointing to the output string.

line-advance

OpenVMS usage: longword_signed
 type: longword (signed)
 access: read only
 mechanism: by reference

Number of lines to advance. The **line-advance** argument is the address of a signed longword that contains the number of lines to advance after the output. This argument is optional.

rendition-set

OpenVMS usage: mask_longword
 type: longword (unsigned)
 access: read only
 mechanism: by reference

SMG\$ Routines

SMG\$PUT_LINE_HIGHWIDE

Attribute specifier. The optional **rendition-set** argument is the address of a longword bit mask in which each attribute set causes the corresponding attribute to be set in the display. The following attributes can be specified using the **rendition-set** argument:

| | |
|---|---|
| SMG\$M_BLINK | Displays blinking characters. |
| SMG\$M_BOLD | Displays characters in higher-than-normal intensity. |
| SMG\$M_REVERSE | Displays characters in reverse video; that is, using the opposite of the default rendition of the virtual display. |
| SMG\$M_UNDERLINE | Displays underlined characters. |
| SMG\$M_INVISIBLE | Specifies invisible characters; that is, the characters exist in the virtual display but do not appear on the pasteboard. |
| SMG\$M_USER1 through SMG\$M_USER8 | Displays user-defined attributes. |

The **display-id** argument must be specified when you use the **rendition-set** argument.

rendition-complement

OpenVMS usage: mask_longword
 type: longword (unsigned)
 access: read only
 mechanism: by reference

Attribute complement specifier. The optional **rendition-complement** argument is the address of a longword bit mask in which each attribute set causes the corresponding attribute to be complemented in the display. All attributes that can be specified with the **rendition-set** argument can be complemented with the **rendition-complement** argument. The **display-id** argument must be specified when you use the **rendition-complement** argument.

The optional arguments **rendition-set** and **rendition-complement** let the user control the attributes of the virtual display. The **rendition-set** argument sets certain virtual display attributes, while **rendition-complement** complements these attributes. If the same bit is specified in both the **rendition-set** and **rendition-complement** parameters, **rendition-set** is evaluated first, followed by **rendition-complement**. By using these two parameters together, the user can control each virtual display attribute in a single procedure call. On a single-attribute basis, the user can cause the following transformations:

| Set | Complement | Action |
|-----|------------|--|
| 0 | 0 | Attribute set to default |
| 1 | 0 | Attribute on |
| 0 | 1 | Attribute set to complement of default setting |
| 1 | 1 | Attribute off |

flags

OpenVMS usage: mask_longword
 type: longword (unsigned)
 access: read only
 mechanism: by reference

SMG\$ Routines SMG\$PUT_LINE_HIGHWIDE

Optional bit mask that specifies the action to be taken if the text does not fit on the line. The **flags** argument is the address of an unsigned longword that contains the flag. The **flags** argument accepts the following values:

| | |
|------------------|--|
| 0 | Does not wrap (default). |
| SMG\$M_WRAP_CHAR | Wraps at the last character on the line. |
| SMG\$M_WRAP_WORD | Wraps at the last space on the line. |

character-set

OpenVMS usage: longword_unsigned
type: longword (unsigned)
access: read only
mechanism: by reference

Specifies the default character set for all text in this virtual display. The **character-set** argument is the address of an unsigned longword that contains the character set code. Valid values are SMG\$C_ASCII (default), and SMG\$C_SPEC_GRAPHICS.

Description

SMG\$PUT_LINE_HIGHWIDE is used to write lines of text with double-height and double-width characters to the virtual display. SMG\$PUT_LINE_HIGHWIDE writes from the current virtual cursor position to the end of the line. If your text does not span to the end of the line, blank spaces are added.

Treatment of text that exceeds the rightmost bounds of the display depends on the **flags** argument. If **flags** specifies wrapping, lines are scrolled **line-advance** times to make room for the overflow characters in the "next" line. If wrapping is not specified, overflow characters are lost.

Following a call to SMG\$PUT_LINE_HIGHWIDE, the virtual cursor position is set to column 1 of the next line where output should occur. The next line where output should occur is determined by the **line-advance** argument. **Line-advance** defaults to 2 so that subsequent calls to SMG\$PUT_LINE_HIGHWIDE do not cause overprinting.

Condition Values Returned

| | |
|----------------|---|
| SS\$NORMAL | Normal successful completion. |
| SMG\$WILUSERMS | Pasteboard is not a video terminal. |
| SMG\$WRONUMARG | Wrong number (or combination of) arguments. |
| LIB\$INVSTRDES | Invalid string descriptor. |

SMG\$PUT_LINE_MULTI

Write Line with Multiple Renditions to Display

The Write Line with Multiple Renditions to Display routine writes lines with multiple renditions to the virtual display, optionally followed by cursor movement sequences.

Format

```
SMG$PUT_LINE_MULTI  display-id ,text ,rendition-string [,rendition-complement]
                    [,line-advance] [,flags] [,direction] [,character-set]
```

Returns

OpenVMS usage: cond_value
type: longword (unsigned)
access: write only
mechanism: by value

Arguments

display-id

OpenVMS usage: identifier
type: longword (unsigned)
access: read only
mechanism: by reference

Identifier of the virtual display to be affected. The **display-id** argument is the address of an unsigned longword that contains this identifier.

text

OpenVMS usage: char_string
type: character string
access: read only
mechanism: by descriptor

Text to be output. The **text** argument is the address of a descriptor pointing to the output string.

rendition-string

OpenVMS usage: char_string
type: character string
access: read only
mechanism: by descriptor

Optional bit mask string that controls the video attributes. The **rendition-string** argument is the address of a descriptor pointing to the bit mask string. Each attribute set causes the corresponding attribute to be set for the corresponding byte in the text string in the display. The following attributes can be specified for each byte using the **rendition-string** argument:

| | |
|--------------|--|
| SMG\$M_BLINK | Displays blinking characters. |
| SMG\$M_BOLD | Displays characters in higher-than-normal intensity. |

SMG\$ Routines

SMG\$PUT_LINE_MULTI

direction

OpenVMS usage: longword_unsigned
type: longword (unsigned)
access: read only
mechanism: by reference

Optional direction specifier. The **direction** argument is the address of an unsigned longword that contains the direction code specifying the scrolling direction, if scrolling is necessary. Valid values are SMG\$M_UP (default) and SMG\$M_DOWN.

character-set

OpenVMS usage: longword_unsigned
type: longword (unsigned)
access: read only
mechanism: by reference

Specifies the default character set for all text in this virtual display. The **character-set** argument is the address of an unsigned longword that contains the character set code. Valid values are SMG\$C_ASCII (default) and SMG\$C_SPEC_GRAPHICS.

Description

SMG\$PUT_LINE_MULTI lets you write lines to the virtual display with multiple renditions, optionally followed by cursor movement sequences. SMG\$PUT_LINE_MULTI writes from the current virtual cursor position to the end of the line. If the text does not span to the end of the line, the remaining portion of the line is filled with blanks.

The treatment of text that extends beyond the rightmost bounds of the virtual display depends on the value of the **flags** argument. If **flags** specifies wrapping, lines are scrolled **line-advance** times to make room for the overflow characters in the “next” line. The “next” line is determined by the scrolling **direction**. If **flags** does not specify wrapping, excess characters are discarded.

Following a call to SMG\$PUT_LINE_MULTI, the virtual cursor position is set to column 1 of the next line where output should occur. The next line where output should occur is determined by the **line-advance** and **direction** arguments; **line-advance** defaults to 1 so that subsequent calls to SMG\$PUT_LINE_MULTI do not cause overprinting.

Condition Values Returned

| | |
|-----------------|---|
| SS\$_NORMAL | Normal successful completion. |
| SMG\$_INVARG | A negative value for line-advance was specified. |
| SMG\$_WILUSERMS | Pasteboard is not a video terminal. |
| SMG\$_WRONUMARG | Wrong number (or combination of) arguments. |
| LIB\$_INVSTRDES | Invalid string descriptor. |

Example

10

```

!+
!This VAX BASIC example demonstrates the capabilities of the
!SMG$PUT_LINE_MULTI routine.
!-

OPTION TYPE = EXPLICIT

EXTERNAL SUB LIB$STOP (LONG BY VALUE)
EXTERNAL LONG FUNCTION SMG$CREATE_PASTEBOARD (LONG)
EXTERNAL LONG FUNCTION SMG$CREATE_VIRTUAL_DISPLAY (LONG, LONG, &
LONG, LONG)
EXTERNAL LONG FUNCTION SMG$PASTE_VIRTUAL_DISPLAY (LONG, LONG, &
LONG, LONG)
EXTERNAL LONG FUNCTION SMG$PUT_LINE (LONG, STRING)
EXTERNAL LONG FUNCTION SMG$PUT_LINE_MULTI (LONG, STRING, STRING, &
STRING, LONG, LONG)

DECLARE LONG pasteboard_id, display_id, display2_id, &
index, ret_status

MAP (rend) STRING dummy = 32
MAP DYNAMIC (rend) BYTE i_rend(15), STRING rendition
REMAP (rend) i_rend(), rendition

EXTERNAL BYTE CONSTANT SMG$M_BOLD
EXTERNAL BYTE CONSTANT SMG$M_REVERSE
EXTERNAL BYTE CONSTANT SMG$M_BLINK
EXTERNAL BYTE CONSTANT SMG$M_UNDERLINE
EXTERNAL LONG CONSTANT SMG$M_BORDER

FOR index = 0 TO 3
    i_rend(index) = SMG$M_REVERSE
NEXT index

FOR index = 4 TO 7
    i_rend(index) = SMG$M_BOLD
NEXT index

FOR index = 8 TO 11
    i_rend(index) = SMG$M_UNDERLINE
NEXT index

FOR index = 12 TO 15
    i_rend(index) = SMG$M_BLINK
NEXT index

REMAP (rend) rendition = 16, i_rend()

ret_status = SMG$CREATE_PASTEBOARD (pasteboard_id)
IF (ret_status AND 1%) = 0% THEN
    CALL LIB$STOP(ret_status BY VALUE)
END IF

ret_status = SMG$CREATE_VIRTUAL_DISPLAY (4,10,display_id, &
SMG$M_BORDER BY REF)
IF (ret_status AND 1%) = 0% THEN
    CALL LIB$STOP(ret_status BY VALUE)
END IF

ret_status = SMG$PASTE_VIRTUAL_DISPLAY (display_id, pasteboard_id, &
2 BY REF, 30 BY REF)
IF (ret_status AND 1%) = 0% THEN
    CALL LIB$STOP(ret_status BY VALUE)
END IF

```

SMG\$ Routines

SMG\$PUT_LINE_MULTI

```
ret_status = SMG$PUT_LINE_MULTI (display_id, '1234567890123456', &  
    rendition,,,1)  
IF (ret_status AND 1%) = 0% THEN  
    CALL LIB$STOP(ret_status BY VALUE)  
END IF
```

END

This example shows the use of SMG\$PUT_LINE_MULTI. In the first line of output, the characters "1234" appear in reverse video. The characters "5678" are highlighted, and the characters "90" are underlined. In the second line of output, the characters "12" are underlined and the characters "3456" are blinking.

SMG\$PUT_LINE_WIDE

Write Double-Width Line

The Write Double-Width Line routine writes a line of double-width text to a virtual display.

Format

```
SMG$PUT_LINE_WIDE  display-id ,text [,line-advance] [,rendition-set]
                   [,rendition-complement] [,flags] [,character-set]
```

Returns

```
OpenVMS usage:  cond_value
type:           longword (unsigned)
access:         write only
mechanism:      by value
```

Arguments

display-id

```
OpenVMS usage:  identifier
type:           longword (unsigned)
access:         read only
mechanism:      by reference
```

Specifies the virtual display affected. The **display-id** argument is the address of an unsigned longword that contains the display identifier.

The display identifier is returned by SMG\$CREATE_VIRTUAL_DISPLAY.

text

```
OpenVMS usage:  char_string
type:           character string
access:         read only
mechanism:      by descriptor
```

Characters to be written to the virtual display. The **text** argument is the address of a descriptor pointing to the text.

line-advance

```
OpenVMS usage:  longword_signed
type:           longword (signed)
access:         read only
mechanism:      by reference
```

Specifies the number of lines to advance after output. The **line-advance** argument is the address of a signed longword integer that contains the number of lines to advance.

rendition-set

```
OpenVMS usage:  mask_longword
type:           longword (unsigned)
access:         read only
mechanism:      by reference
```

SMG\$ Routines

SMG\$PUT_LINE_WIDE

Attribute specifier. The optional **rendition-set** argument is the address of a longword bit mask in which each attribute set causes the corresponding attribute to be set in the display. The following attributes can be specified using the **rendition-set** argument:

| | |
|---|---|
| SMG\$M_BLINK | Displays blinking characters. |
| SMG\$M_BOLD | Displays characters in higher-than-normal intensity. |
| SMG\$M_REVERSE | Displays characters in reverse video; that is, using the opposite of the default rendition of the virtual display. |
| SMG\$M_UNDERLINE | Displays underlined characters. |
| SMG\$M_INVISIBLE | Specifies invisible characters; that is, the characters exist in the virtual display but do not appear on the pasteboard. |
| SMG\$M_USER1 through SMG\$M_USER8 | Displays user-defined attributes. |

The **display-id** argument must be specified when you use the **rendition-set** argument.

rendition-complement

OpenVMS usage: mask_longword
type: longword (unsigned)
access: read only
mechanism: by reference

Attribute complement specifier. The optional **rendition-complement** argument is the address of a longword bit mask in which each attribute set causes the corresponding attribute to be complemented in the display. All attributes that can be specified with the **rendition-set** argument can be complemented with the **rendition-complement** argument. The **display-id** argument must be specified when you use the **rendition-complement** argument.

The optional arguments **rendition-set** and **rendition-complement** let the user control the attributes of the virtual display. The **rendition-set** argument sets certain virtual display attributes, while **rendition-complement** complements these attributes. If the same bit is specified in both the **rendition-set** and **rendition-complement** parameters, **rendition-set** is evaluated first, followed by **rendition-complement**. By using these two parameters together, the user can control each virtual display attribute in a single procedure call. On a single-attribute basis, the user can cause the following transformations:

| Set | Complement | Action |
|-----|------------|--|
| 0 | 0 | Attribute set to default |
| 1 | 0 | Attribute on |
| 0 | 1 | Attribute set to complement of default setting |
| 1 | 1 | Attribute off |

flags

OpenVMS usage: mask_longword
type: longword (unsigned)
access: read only
mechanism: by reference

Optional bit mask that specifies the action to take if the text does not fit on the line. The **flags** argument is the address of an unsigned longword that contains the flag. The **flags** argument accepts the following values:

| | |
|------------------|--|
| 0 | Does not wrap (default). |
| SMG\$M_WRAP_CHAR | Wraps at the last character on the line. |
| SMG\$M_WRAP_WORD | Wraps at the last space on the line. |

character-set

OpenVMS usage: longword_unsigned
 type: longword (unsigned)
 access: read only
 mechanism: by reference

Specifies the default character set for all text in this virtual display. The **character-set** argument is the address of an unsigned longword that contains the character set code. Valid values are SMG\$C_ASCII (default), and SMG\$C_SPEC_GRAPHICS.

Description

SMG\$PUT_LINE_WIDE writes lines of double-width text to the virtual display. SMG\$PUT_LINE_WIDE writes out the entire line, starting at the current virtual cursor position. If the caller's text does not span the entire line, the line is filled with blanks.

If the **flags** argument specifies wrapping, lines are scrolled **line-advance** times to make room for the overflow characters in the "next" line. If **flags** does not specify wrapping, excess characters are discarded.

Following a call to SMG\$PUT_LINE_WIDE, the virtual cursor position is set to column 1 of the next line where output should occur. The next line where output should occur is determined by the **line-advance** argument; **line-advance** defaults to 1 so that subsequent calls to SMG\$PUT_LINE_WIDE will not cause overprinting.

Other routines that you can use to write text to a virtual display are SMG\$PUT_LINE and SMG\$PUT_LINE_HIGHWIDE.

Condition Values Returned

| | |
|----------------|-------------------------------------|
| SS\$NORMAL | Normal successful completion. |
| SMG\$INVDIS_ID | Invalid display-id . |
| SMG\$WILUSERMS | Pasteboard is not a video terminal. |
| SMG\$WRONUMARG | Wrong number of arguments. |
| LIB\$INVSTRDES | Invalid string descriptor. |

SMG\$ Routines

SMG\$PUT_LINE_WIDE

Example

```
C+
C This Fortran example program demonstrates the use of
C SMG$PUT_LINE_WIDE.
C
C Include the SMG definitions. In particular, we want SMG$M_BORDER and
C SMG$M_UNDERLINE.
C-

      INCLUDE '($SMGDEF)'
      INTEGER SMG$CREATE_VIRTUAL_DISPLAY, SMG$CREATE_PASTEBOARD
      INTEGER SMG$PASTE_VIRTUAL_DISPLAY, SMG$PUT_LINE_WIDE
      INTEGER DISPLAY1, PASTE1, ROWS, COLUMNS, STATUS
      CHARACTER*34 TEXT(3)

C+
C Create a virtual display with a border by calling
C SMG$CREATE_VIRTUAL_DISPLAY.
C-

      ROWS = 7
      COLUMNS = 70

      STATUS = SMG$CREATE_VIRTUAL_DISPLAY
1     (ROWS, COLUMNS, DISPLAY1, SMG$M_BORDER)
      IF (.NOT. STATUS) CALL LIB$SIGNAL(%VAL(STATUS))

C+
C Call SMG$CREATE_PASTEBOARD to create the pasteboard.
C-

      STATUS = SMG$CREATE_PASTEBOARD (PASTE1)
      IF (.NOT. STATUS) CALL LIB$SIGNAL(%VAL(STATUS))

C+
C Use SMG$PUT_LINE to put data in the virtual display.
C-

      TEXT(1) = 'This virtual display has 7'
      TEXT(2) = 'rows and 70 columns.'
      TEXT(3) = 'Text entered by SMG$PUT_LINE_WIDE.'

C+
C After the first line of text is printed, advance two lines.
C-

      STATUS = SMG$PUT_LINE_WIDE ( DISPLAY1, TEXT(1), 2 )
      IF (.NOT. STATUS) CALL LIB$SIGNAL(%VAL(STATUS))

C+
C Underline the next line of text. Notice that 34 characters are being
C underlined. Advance one line of text after displaying the line.
C-

      STATUS = SMG$PUT_LINE_WIDE ( DISPLAY1, TEXT(2), 1,
1     SMG$M_UNDERLINE )
      IF (.NOT. STATUS) CALL LIB$SIGNAL(%VAL(STATUS))

C+
C Display the third line of text.
C-

      STATUS = SMG$PUT_LINE_WIDE ( DISPLAY1, TEXT(3) )
      IF (.NOT. STATUS) CALL LIB$SIGNAL(%VAL(STATUS))

C+
C Paste the virtual display using SMG$PASTE_VIRTUAL_DISPLAY.
C-
```

SMG\$ Routines SMG\$PUT_LINE_WIDE

```
STATUS = SMG$PASTE_VIRTUAL_DISPLAY ( DISPLAY1, PASTE1, 4, 5 )  
IF (.NOT. STATUS) CALL LIB$SIGNAL(%VAL(STATUS))  
END
```

The output generated by this Fortran program is shown in Figure SMG-35.

Figure SMG-35 Output Generated by Fortran Program Calling SMG\$PUT_LINE_WIDE



ZK-4143-GE

SMG\$PUT_PASTEBOARD

Output Pasteboard Using Routine

The Output Pasteboard Using Routine routine accesses the contents of a pasteboard.

Format

SMG\$PUT_PASTEBOARD pasteboard-id ,action-routine [,user-argument] [,flags]

Returns

OpenVMS usage: cond_value
type: longword (unsigned)
access: write only
mechanism: by value

Arguments

pasteboard-id

OpenVMS usage: identifier
type: longword (unsigned)
access: read only
mechanism: by reference

Pasteboard identifier. The **pasteboard-id** argument is the address of an unsigned longword containing the pasteboard identifier.

action-routine

OpenVMS usage: procedure
type: procedure value
access: read only
mechanism: by value

Pasteboard routine to be called. The **action-routine** argument is the address of the routine's procedure value. Because SMG\$ cannot determine the resulting type of device, device-independent characters (plus sign [+], minus sign [-], vertical bar [|]) are used to draw lines.

The **action-routine** accepts two arguments:

- A pointer to a string descriptor describing the line in the pasteboard.
- The user argument, or 0, passed by value.

The action routine should return a success status (low bit set) as a return value, otherwise SMG\$PUT_PASTEBOARD will terminate, and the status value will be returned as the return value for SMG\$PUT_PASTEBOARD.

user-argument

OpenVMS usage: user_arg
type: longword (unsigned)
access: read only
mechanism: by value

The argument you supply to the **action-routine**. The **user-argument** argument is an unsigned longword that contains the value to be passed to the action routine. If **user-argument** is omitted, a 0 will be passed as the user argument.

flags

OpenVMS usage: mask_longword
type: longword (unsigned)
access: read only
mechanism: by reference

Optional bit mask that specifies whether a form feed is passed to the action routine. The **flags** argument is the address of an unsigned longword that contains the flag. Valid values for **flags** are as follows:

| | |
|------------------|---|
| 0 | No form-feed line is sent. |
| SMG\$M_FORM_FEED | The first line passed to the action routine is a form feed. |

Description

The SMG\$PUT_PASTEBOARD routine accesses the contents of a pasteboard. The caller specifies an action routine that will be called once for each line in the pasteboard. The action routine should return a success status (low bit set) as a return value, or SMG\$PUT_PASTEBOARD will terminate.

Condition Values Returned

| | |
|------------|---|
| SS\$NORMAL | Normal successful completion. |
| Other | Any error returned by the action routine. |

SMG\$ Routines

SMG\$PUT_STATUS_LINE

SMG\$PUT_STATUS_LINE

Output Line of Text to Hardware Status Line

The Output Line of Text to Hardware Status Line routine outputs a line of text to the hardware status line.

Format

SMG\$PUT_STATUS_LINE pasteboard-id ,text

Returns

OpenVMS usage: cond_value
type: longword (unsigned)
access: write only
mechanism: by value

Arguments

pasteboard-id

OpenVMS usage: identifier
type: longword (unsigned)
access: read only
mechanism: by reference

Specifies the pasteboard containing the hardware status line. The **pasteboard-id** argument is the address of an unsigned longword that contains the pasteboard identifier.

text

OpenVMS usage: char_string
type: character string
access: read only
mechanism: by descriptor

The characters to be written to the hardware status line. The **text** argument is the address of a descriptor pointing to the text.

Description

The SMG\$PUT_STATUS_LINE routine outputs a line of text to the terminal's hardware status line. Some terminals have a hardware status line at the bottom (25th line) of the screen. If this status line has been set as "host writable," you can use this routine to output a line of text to the status line. (If the hardware status line is not available, the error SMG\$_OPNOTSUP is returned.) The text is output in reverse video.

Condition Values Returned

| | |
|-----------------|------------------------------------|
| SS\$_NORMAL | Normal successful completion. |
| SMG\$_INVPAS_ID | Invalid pasteboard-id . |
| SMG\$_OPNOTSUP | No hardware status line available. |
| SMG\$_WRONUMARG | Wrong number of arguments. |
| LIB\$_INVARG | Invalid argument. |

SMG\$READ_COMPOSED_LINE

Read Composed Line

The Read Composed Line routine reads a line of input composed of normal keystrokes and equivalence strings.

Format

```
SMG$READ_COMPOSED_LINE keyboard-id [,key-table-id] ,resultant-string  
                        [,prompt-string] [,resultant-length] [,display-id]  
                        [,flags] [,initial-string] [,timeout] [,rendition-set]  
                        [,rendition-complement] [,word-terminator-code]
```

Returns

OpenVMS usage: cond_value
type: longword (unsigned)
access: write only
mechanism: by value

Arguments

keyboard-id

OpenVMS usage: identifier
type: longword (unsigned)
access: read only
mechanism: by reference

Specifies the virtual keyboard from which input is to be read. The **keyboard-id** argument is the address of an unsigned longword that contains the keyboard identifier.

The keyboard identifier is returned by SMG\$CREATE_VIRTUAL_KEYBOARD.

key-table-id

OpenVMS usage: identifier
type: longword (unsigned)
access: read only
mechanism: by reference

Specifies the key definition table to be used for translating keystrokes. The **key-table-id** argument is the address of an unsigned longword that contains the key definition table identifier.

The key definition table identifier is returned by SMG\$CREATE_KEY_TABLE.

resultant-string

OpenVMS usage: char_string
type: character string
access: write only
mechanism: by descriptor

String into which SMG\$READ_COMPOSED_LINE writes the complete composed line. The **resultant-string** argument is the address of a descriptor pointing to the string in which the composed line is written.

prompt-string

OpenVMS usage: char_string
type: character string
access: read only
mechanism: by descriptor

String used to prompt for the read operation. The **prompt-string** argument is the address of a descriptor pointing to the prompt string.

resultant-length

OpenVMS usage: word_unsigned
type: word (unsigned)
access: write only
mechanism: by reference

Receives the number of characters read or the maximum length of **resultant-string**, whichever is less. The **resultant-length** argument is the address of an unsigned longword into which SMG\$READ_COMPOSED_LINE writes the number of characters read.

display-id

OpenVMS usage: identifier
type: longword (unsigned)
access: read only
mechanism: by reference

Display identifier. The **display-id** argument is the address of an unsigned longword that contains the display identifier. This argument is optional only if you are not using the Screen Management Facility's output routines.

If you are using the Screen Management Facility input and output routines, this argument specifies the virtual display in which the input is to occur. The virtual display specified must be pasted to the same pasteboard as specified by **keyboard-id** and must not be occluded. You cannot accept input from an occluded area of the virtual display.

In the case of multiple virtual displays, each virtual display has an associated virtual cursor position. At the same time, there is a single physical cursor position corresponding to the current location of the physical cursor. If the **display-id** argument is specified, the read begins at the current virtual cursor position in the specified virtual display. If the display identifier is omitted, the read begins in the current physical cursor position. The length of the **prompt-string** plus the key entered is limited to the number of visible columns in the display.

Note

This virtual display must be pasted in column 1 and may not have any other virtual displays to its right. This restriction is necessary because otherwise any occurrence of Ctrl/R or Ctrl/U would blank out the entire line, including any output pasted to the right. To circumvent this restriction, you can use SMG\$REPAINT_LINE whenever a Ctrl/R or Ctrl/U is encountered.

SMG\$ Routines

SMG\$READ_COMPOSED_LINE

flags

OpenVMS usage: mask_longword
type: longword (unsigned)
access: read only
mechanism: by reference

Optional bit mask that specifies enabled keys. The **flags** argument is the address of an unsigned longword that contains the flag. Valid values for **flags** are as follows:

| | |
|------------------|---|
| 0 | Line editing is enabled and function keys (F6 to F14) cannot be used. |
| SMG\$M_FUNC_KEYS | Function keys (F6 to F14) may be used and line editing is disabled. |
| SMG\$M_NOKEEP | Lines entered in the recall buffer are not saved. |
| SMG\$M_NORECALL | Line recall is disabled for this I/O only. |

Because the OpenVMS terminal driver uses the function keys (F6 to F14) for line editing on some terminals, you cannot have function keys and line editing enabled at the same time.

initial-string

OpenVMS usage: char_string
type: character string
access: read only
mechanism: by descriptor

Optional string that contains the initial characters of the field. The **initial-string** argument is the address of a descriptor pointing to the string. The string is written to the display in the input area, as if it had been entered from the keyboard. It may be edited in the usual way (provided that the SMG\$M_FUNC_KEYS flag is not set).

timeout

OpenVMS usage: longword_signed
type: longword (signed)
access: read only
mechanism: by reference

Optional timeout count. The **timeout** argument is the address of a signed longword containing the timeout count. If the **timeout** argument is specified, all characters entered before the timeout are returned in the buffer. If the **timeout** argument is omitted, characters are returned in the buffer until a terminator is encountered.

rendition-set

OpenVMS usage: mask_longword
type: longword (unsigned)
access: read only
mechanism: by reference

Attribute specifier. The optional **rendition-set** argument is the address of a longword bit mask in which each attribute set causes the corresponding attribute to be set in the display. The following attributes can be specified using the **rendition-set** argument:

| | |
|---|---|
| SMG\$M_BLINK | Displays blinking characters. |
| SMG\$M_BOLD | Displays characters in higher-than-normal intensity. |
| SMG\$M_REVERSE | Displays characters in reverse video; that is, using the opposite of the default rendition of the virtual display. |
| SMG\$M_UNDERLINE | Displays underlined characters. |
| SMG\$M_INVISIBLE | Specifies invisible characters; that is, the characters exist in the virtual display but do not appear on the pasteboard. |
| SMG\$M_USER1 through SMG\$M_USER8 | Displays user-defined attributes. |

The **display-id** argument must be specified when you use the **rendition-set** argument.

rendition-complement

OpenVMS usage: mask_longword
 type: longword (unsigned)
 access: read only
 mechanism: by reference

Attribute complement specifier. The optional **rendition-complement** argument is the address of a longword bit mask in which each attribute set causes the corresponding attribute to be complemented in the display. All of the attributes that can be specified with the **rendition-set** argument can be complemented with the **rendition-complement** argument. The **display-id** argument must be specified when you use the **rendition-complement** argument.

The optional arguments **rendition-set** and **rendition-complement** let the user control the attributes of the virtual display. The **rendition-set** argument sets certain virtual display attributes, while **rendition-complement** complements these attributes. If the same bit is specified in both the **rendition-set** and **rendition-complement** parameters, **rendition-set** is evaluated first, followed by **rendition-complement**. By using these two parameters together, the user can control each virtual display attribute in a single procedure call. On a single-attribute basis, the user can cause the following transformations:

| Set | Complement | Action |
|-----|------------|--|
| 0 | 0 | Attribute set to default |
| 1 | 0 | Attribute on |
| 0 | 1 | Attribute set to complement of default setting |
| 1 | 1 | Attribute off |

word-terminator-code

OpenVMS usage: word_unsigned
 type: word (unsigned)
 access: write only
 mechanism: by reference

Key terminator code. The **word-terminator-code** argument is an unsigned word into which is written a code indicating what character or key terminated the read. Key terminator codes are of the form SMG\$K_TRM_ *keyname*. The key names are listed in Table 3-1.

SMG\$ Routines

SMG\$READ_COMPOSED_LINE

Description

SMG\$READ_COMPOSED_LINE reads a line composed of normal keystrokes and key equivalence strings as defined in the specified key definition table. Attributes of the key definition control whether the equivalence string is echoed and whether the read terminates with the defined keystroke. Normal keystrokes are always echoed.

A carriage return always terminates the read operation. If Ctrl/Z is pressed and there is no definition for Ctrl/Z in the key definition table, "EXIT" is echoed and the read is terminated. If Ctrl/Z was the first character on the line, SMG\$_EOF is returned. Otherwise, SMG\$_EOF is returned on the next read operation. SMG\$_EOF is also returned if OpenVMS RMS is used for the input operation and RMS returns RMS\$_EOF. No other terminators are recognized except those specified as attributes in a key definition.

If the arrow keys and Ctrl/B are not defined, the previous lines read with the SMG\$READ_XXXX routines can be recalled using the arrow keys. The number of lines saved for later recall depends upon the **recall-size** argument in SMG\$CREATE_VIRTUAL_KEYBOARD. The default is 20 lines.

Note that SMG\$READ_COMPOSED_LINE calls the SMG\$FLUSH_BUFFER routine before performing the input operation. This ensures that the screen image is up to date at the time of the input operation. Display batching for both the pasteboard and virtual display must be off when you use SMG\$READ_COMPOSED_LINE.

Condition Values Returned

| | |
|-----------------|---|
| SS\$_NORMAL | Normal successful completion. |
| SS\$_ABORT | I/O operation aborted during execution (by SMG\$CANCEL_INPUT). |
| SS\$_CANCEL | I/O operation canceled while queued (by SMG\$CANCEL_INPUT). |
| SMG\$_EOF | End of file. |
| SMG\$_ILLBATFNC | Input not allowed from a batched display. |
| SMG\$_INVCOL | Invalid column. The read operation attempts to use a column outside the virtual display. |
| SMG\$_INVDIS_ID | Invalid display-id . |
| SMG\$_INVKBD_ID | Invalid keyboard-id . |
| SMG\$_INVKTB_ID | Invalid key-table-id . |
| SMG\$_KBDIN_USE | On a second or subsequent read operation, multiple QIOs were attempted on the same channel. |
| SMG\$_WRONUMARG | Wrong number of arguments. |

Any condition values returned by LIB\$SCOPY_R_DX, \$GET (except RMS\$_EOF), or \$QIOW.

SMG\$READ_FROM_DISPLAY

Read Text from Display

The Read Text from Display routine reads a line of text from a virtual display.

Format

SMG\$READ_FROM_DISPLAY display-id ,resultant-string [,terminator-string]
[,start-row] [,rendition-string]

Returns

OpenVMS usage: cond_value
type: longword (unsigned)
access: write only
mechanism: by value

Arguments

display-id

OpenVMS usage: identifier
type: longword (unsigned)
access: read only
mechanism: by reference

Specifies the virtual display from which text is read. The **display-id** argument is the address of an unsigned longword that contains the display identifier.

The display identifier is returned by SMG\$CREATE_VIRTUAL_DISPLAY.

resultant-string

OpenVMS usage: char_string
type: character string
access: write only
mechanism: by descriptor

String into which SMG\$READ_FROM_DISPLAY writes the information read from the virtual display. The **resultant-string** argument is the address of a descriptor pointing to the string into which the string is written.

terminator-string

OpenVMS usage: char_string
type: character string
access: read only
mechanism: by descriptor

String containing a terminator or terminators that end the backward search, thus determining the starting position of the returned string. The **terminator-string** argument is the address of a descriptor pointing to the string of terminators. If **terminator-string** is omitted, no back searching is performed; the returned string starts with the character at the current cursor position.

SMG\$ Routines

SMG\$READ_FROM_DISPLAY

start-row

OpenVMS usage: longword_signed
type: longword (signed)
access: read only
mechanism: by reference

The **start-row** argument is the address of a signed longword that contains the row of the virtual display to read from. This is an optional argument.

rendition-string

OpenVMS usage: char_string
type: character string
access: write only
mechanism: by descriptor

Optional bit mask string that controls the video attributes. The **rendition-string** argument is the address of a descriptor pointing to the bit mask string. Each attribute set causes the corresponding attribute to be set for the corresponding byte in the text string in the display. The following attributes can be specified for each byte using the **rendition-string** argument:

| | |
|------------------|---|
| SMG\$M_BLINK | Displays blinking characters. |
| SMG\$M_BOLD | Displays characters in higher-than-normal intensity. |
| SMG\$M_REVERSE | Displays characters in reverse video; that is, using the opposite of the default rendition of the virtual display. |
| SMG\$M_UNDERLINE | Displays underlined characters. |
| SMG\$M_INVISIBLE | Specifies invisible characters; that is, the characters exist in the virtual display but do not appear on the pasteboard. |

Description

SMG\$READ_FROM_DISPLAY returns a string that contains some or all of the text on the current line of the specified virtual display. If the **terminator-string** argument is omitted, the contents of the current line (from the current column position to the rightmost column position) are returned. If the **start-row** argument is passed, the contents of line **start-row** from column 1 to the rightmost column are returned in **resultant-string**. If the **start-row** argument is passed, the **terminator-string** argument is ignored.

If you specify **terminator-string**, each character in it serves as a terminator for back searching; that is, the process of determining the first character position to be returned. If none of the specified terminators is encountered, the search is terminated at the first character position on the line.

Device-independent characters (plus sign [+], minus sign [-], and vertical bar [|]) are returned for drawn lines.

Condition Values Returned

| | |
|------------------|--|
| SS\$ _NORMAL | Normal successful completion. |
| SMG\$ _DSPIN_USE | An SMG\$ call was made from an AST routine that interrupted an SMG\$ call on the same display. |

| | |
|-----------------|---|
| SMG\$_INVDIS_ID | Invalid display-id . |
| SMG\$_KBDIN_USE | On a second or subsequent read operation, multiple QIOs were attempted on the same channel. |
| LIB\$_INVSTRDES | Invalid string descriptor. |
| LIB\$_INSVIRMEM | Insufficient virtual memory. |

Example

```

C+
C This Fortran example demonstrates the use of SMG$READ_FROM_DISPLAY.
C-

C+
C Include the SMG definitions. In particular, we want SMG$_BORDER.
C-

        IMPLICIT INTEGER (A-Z)
        INCLUDE '($SMGDEF)'
        CHARACTER*80 TEXT

C+
C Use SMG$CREATE_VIRTUAL_DISPLAY to create the virtual display
C and give it a border.
C-

        ROWS = 5
        COLUMNS = 60

        STATUS = SMG$CREATE_VIRTUAL_DISPLAY
1 (ROWS, COLUMNS, DISPLAY1, SMG$_BORDER)
        IF (.NOT. STATUS) CALL LIB$SIGNAL(%VAL(STATUS))

C+
C Create the pasteboard by calling SMG$CREATE_PASTEBOARD.
C-

        STATUS = SMG$CREATE_PASTEBOARD (PASTE1)
        IF (.NOT. STATUS) CALL LIB$SIGNAL(%VAL(STATUS))

C+
C Call SMG$PASTE_VIRTUAL_DISPLAY and SMG$PUT_LINE to paste
C the virtual display and put some text on line 2.
C-

        STATUS = SMG$PASTE_VIRTUAL_DISPLAY ( DISPLAY1, PASTE1, 2, 10 )
        IF (.NOT. STATUS) CALL LIB$SIGNAL(%VAL(STATUS))

        STATUS = SMG$PUT_LINE ( DISPLAY1, ' ' )
        IF (.NOT. STATUS) CALL LIB$SIGNAL(%VAL(STATUS))

        STATUS = SMG$PUT_LINE ( DISPLAY1,
1          'This is an example of using SMG$READ_FROM_DISPLAY.' )
        IF (.NOT. STATUS) CALL LIB$SIGNAL(%VAL(STATUS))

C+
C Use SMG$READ_FROM_DISPLAY to read line 2 from the virtual
C display, starting at column 22.
C-

        STATUS = SMG$SET_CURSOR_ABS ( DISPLAY1, 2, 22 )
        IF (.NOT. STATUS) CALL LIB$SIGNAL(%VAL(STATUS))

```

SMG\$ Routines

SMG\$READ_FROM_DISPLAY

```
C+
C Search line 2 from column 22 to column 1 for the null string.
C Since no terminator will be supplied, no "back-searching" will take
C place. TEXT will be assigned the "value" of the line from
C column 22 to the rightmost column.
C-

      STATUS = SMG$READ_FROM_DISPLAY ( DISPLAY1, TEXT )
      IF (.NOT. STATUS) CALL LIB$SIGNAL(%VAL(STATUS))

C+
C Put the line of text found into the virtual display at row 4,
C column 10 by calling SMG$SET_CURSOR_ABS and SMG$PUT_LINE.
C-

      STATUS = SMG$SET_CURSOR_ABS ( DISPLAY1, 4, 10 )
      IF (.NOT. STATUS) CALL LIB$SIGNAL(%VAL(STATUS))

      STATUS = SMG$PUT_LINE ( DISPLAY1, TEXT )
      IF (.NOT. STATUS) CALL LIB$SIGNAL(%VAL(STATUS))

C+
C Use SMG$SET_CURSOR_ABS to set the cursor back to line 2, column 22.
C-

      STATUS = SMG$SET_CURSOR_ABS ( DISPLAY1, 2, 22 )
      IF (.NOT. STATUS) CALL LIB$SIGNAL(%VAL(STATUS))

C+
C Use SMG$READ_FROM_DISPLAY to search line 2 from column 22 to
C column 1 for an "f". Now, "back-searching" will take place.
C Starting at column 22, "back-track" to column 1 looking for "f".
C Text will then be assigned the "value" of the line from the
C present cursor position (where the "f" is, to the rightmost
C column).
C-

      STATUS = SMG$READ_FROM_DISPLAY ( DISPLAY1, TEXT, 'f' )
      IF (.NOT. STATUS) CALL LIB$SIGNAL(%VAL(STATUS))

C+
C Put the line of text found into the virtual display at row 4, column 10.
C-

      STATUS = SMG$SET_CURSOR_ABS ( DISPLAY1, 5, 10 )
      IF (.NOT. STATUS) CALL LIB$SIGNAL(%VAL(STATUS))

      STATUS = SMG$PUT_LINE ( DISPLAY1, TEXT )
      IF (.NOT. STATUS) CALL LIB$SIGNAL(%VAL(STATUS))

      END
```

The output generated by this Fortran program is shown in Figure SMG-36.

Figure SMG-36 Output Generated by Fortran Program Calling SMG\$READ_FROM_DISPLAY

```
This is an example of using SMG$READ_FROM_DISPLAY.  
      using SMG$READ_FROM_DISPLAY.  
f using SMG$READ_FROM_DISPLAY.
```

ZK-4134-GE

SMG\$READ_KEYSTROKE

Read a Single Character

The Read a Single Character routine reads a keystroke and returns that keystroke's terminator code.

Format

```
SMG$READ_KEYSTROKE keyboard-id ,word-terminator-code [,prompt-string]
                    [,timeout] [,display-id] [,rendition-set]
                    [,rendition-complement]
```

Returns

OpenVMS usage: cond_value
type: longword (unsigned)
access: write only
mechanism: by value

Arguments

keyboard-id

OpenVMS usage: identifier
type: longword (unsigned)
access: read only
mechanism: by reference

Keyboard identifier. The **keyboard-id** argument is an unsigned longword containing the identifier of the virtual keyboard from which to read.

You can create a virtual keyboard by calling the SMG\$CREATE_VIRTUAL_KEYBOARD routine.

word-terminator-code

OpenVMS usage: word_unsigned
type: word (unsigned)
access: write only
mechanism: by reference

Key terminator code. The **word-terminator-code** argument is an unsigned word into which is written a code indicating what character or key terminated the read. Key terminator codes are of the form SMG\$K_TRM_ *keyname*. The key names are listed in Table 3-1.

prompt-string

OpenVMS usage: char_string
type: character string
access: read only
mechanism: by descriptor

Prompt string. The **prompt-string** argument is an optional string used as the prompt for the read operation.

timeout

OpenVMS usage: longword_signed
type: longword (signed)
access: read only
mechanism: by reference

Timeout count. The **timeout** argument is optional. If specified, any character typed before the timeout is returned in the buffer.

display-id

OpenVMS usage: identifier
type: longword (unsigned)
access: read only
mechanism: by reference

Display identifier. The optional **display-id** argument is the address of an unsigned longword that contains the identifier of the virtual display in which the read is to be performed. If the optional **prompt-string** argument is specified while there are multiple virtual displays pasted, the **display-id** argument is required to determine in which virtual display the prompt string will be written. If the **prompt-string** argument is not specified, do not specify the **display-id** argument.

In the case of multiple virtual displays, each virtual display has an associated virtual cursor position. At the same time, there is a single physical cursor position corresponding to the current location of the physical cursor. If the **display-id** argument is specified, the read begins at the current virtual cursor position in the specified virtual display. If **display-id** is omitted, the read begins in the current physical cursor position. Note that the length of the **prompt-string** plus the key entered is limited to the number of visible columns in the display.

rendition-set

OpenVMS usage: mask_longword
type: longword (unsigned)
access: read only
mechanism: by reference

Attribute specifier. The optional **rendition-set** argument is the address of a longword bit mask in which each attribute set causes the corresponding attribute to be set in the display. The following attributes can be specified using the **rendition-set** argument:

| | |
|---|--|
| SMG\$M_BLINK | Displays blinking characters. |
| SMG\$M_BOLD | Displays characters in higher-than-normal intensity. |
| SMG\$M_REVERSE | Displays characters in reverse video; that is, using the opposite of the default rendition of the virtual display. |
| SMG\$M_UNDERLINE | Displays underlined characters. |
| SMG\$M_USER1 through SMG\$M_USER8 | Displays user-defined attributes. |

The **display-id** argument must be specified when you use the **rendition-set** argument.

SMG\$ Routines

SMG\$READ_KEYSTROKE

rendition-complement

OpenVMS usage: mask_longword
type: longword (unsigned)
access: read only
mechanism: by reference

Attribute complement specifier. The optional **rendition-complement** argument is the address of a longword bit mask in which each attribute set causes the corresponding attribute to be complemented in the display. All of the attributes that can be specified with the **rendition-set** argument can be complemented with the **rendition-complement** argument. The **display-id** argument must be specified when you use the **rendition-complement** argument.

The optional arguments **rendition-set** and **rendition-complement** let the user control the attributes of the virtual display. The **rendition-set** argument sets certain virtual display attributes, while **rendition-complement** complements these attributes. If the same bit is specified in both the **rendition-set** and **rendition-complement** parameters, **rendition-set** is evaluated first, followed by **rendition-complement**. By using these two parameters together, the user can control each virtual display attribute in a single procedure call. On a single-attribute basis, the user can cause the following transformations:

| Set | Complement | Action |
|-----|------------|--|
| 0 | 0 | Attribute set to default |
| 1 | 0 | Attribute on |
| 0 | 1 | Attribute set to complement of default setting |
| 1 | 1 | Attribute off |

Description

SMG\$READ_KEYSTROKE reads a keystroke from the specified virtual keyboard and returns the terminator code of that keystroke in the form SMG\$K_TRM_ *keyname*. The keystroke entered to be read is not echoed on the screen. This keystroke can be any standard alphabetic character, any keypad or function key, or one of the directional arrows.

Note that display batching for both the pasteboard and the virtual display must be off when you use SMG\$READ_KEYSTROKE.

You can enter all keys on the VT100, VT200 series, VT300 series, VT400 series, and VT500 series keyboards with the following exceptions:

- The Compose Character key on VT200 series, VT300 series, VT400 series, and VT500 series keyboards. (The VT100 has no Compose Character key.)
- The Escape key.
- The Shift keys.
- The keys F1 through F5 on VT200 series, VT300 series, VT400 series, and VT500 series keyboards. (The VT100 does not have keys F1 through F5.)

There are certain keys and key definitions that Compaq strongly suggests you avoid defining. SMG\$ does not return an error when you use these keys and key definitions, but the definitions you assign to these key combinations are not executed unless you set your terminal in the following special ways at the DCL level:

- Ctrl/C, Ctrl/O, Ctrl/X, and F6 — To read these keys, you must first enter the DCL command SET TERMINAL/PASTHRU.
- Ctrl/T, Ctrl/Y — To read these keys, you must first enter either the DCL command SET TERMINAL/PASTHRU or SET NOCONTROL, or both.
- Ctrl/S, Ctrl/Q — To read these keys, you must first enter the DCL command SET TERMINAL/NOTTSYNC.

Warning

Compaq recommends that you not use these special terminal settings. The settings can cause unpredictable results if you do not understand all the implications of changing the default settings to give control to the terminal driver.

Condition Values Returned

| | |
|-----------------|---|
| SS\$_NORMAL | Normal successful completion. |
| SS\$_ABORT | I/O operation aborted during execution (by SMG\$CANCEL_INPUT). |
| SS\$_CANCEL | I/O operation canceled while queued (by SMG\$CANCEL_INPUT). |
| SS\$_xxx | Any error from \$QIOW. |
| SMG\$_EOF | End of file. |
| SMG\$_INVDIS_ID | Invalid display-id . |
| SMG\$_INVKBD_ID | Invalid keyboard-id . |
| SMG\$_KBDIN_USE | On a second or subsequent read operation, multiple QIOs were attempted on the same channel. |
| SMG\$_WRONUMARG | Wrong number of arguments. |
| LIB\$_xxx | Any error from LIB\$SCOPY_R_DX. |
| RMS\$_xxx | Any error from \$GET (except RMS\$_EOF). |

Examples

1. C+
C This Fortran example program demonstrates the use of
C SMG\$READ_KEYSTROKE.
C-

C+
C This routine creates a virtual display and writes it to the pasteboard.
C Data is placed in the virtual display using SMG\$PUT_CHARS.
C
C First, include the SMG definitions. In particular, we want SMG\$_BORDER.
C-

```

IMPLICIT INTEGER (A-Z)
INCLUDE '($SMGDEF)'
CHARACTER*3 TEXT
CHARACTER*27 TEXT_OUTPUT

```

SMG\$ Routines

SMG\$READ_KEYSTROKE

```
C+
C Use SMG$CREATE_VIRTUAL_DISPLAY to create a virtual
C display with a border.
C-

        ROWS = 7
        COLUMNS = 60

        STATUS = SMG$CREATE_VIRTUAL_DISPLAY
1         (ROWS, COLUMNS, DISPLAY1, SMG$M_BORDER)
        IF (.NOT. STATUS) CALL LIB$SIGNAL(%VAL(STATUS))

C+
C Create the pasteboard using SMG$CREATE_PASTEBOARD.
C-

        STATUS = SMG$CREATE_PASTEBOARD ( PASTE1 )
        IF (.NOT. STATUS) CALL LIB$SIGNAL(%VAL(STATUS))

C+
C Use SMG$CREATE_VIRTUAL_KEYBOARD to create a virtual keyboard.
C-

        STATUS = SMG$CREATE_VIRTUAL_KEYBOARD ( KEYBOARD1 )
        IF (.NOT. STATUS) CALL LIB$SIGNAL(%VAL(STATUS))

C+
C Using SMG$PASTE_VIRTUAL_DISPLAY, paste the virtual display
C at row 3, column 9.
C-

        STATUS = SMG$PASTE_VIRTUAL_DISPLAY ( DISPLAY1, PASTE1, 3, 9 )
        IF (.NOT. STATUS) CALL LIB$SIGNAL(%VAL(STATUS))

1        STATUS = SMG$PUT_LINE ( DISPLAY1,
        'Enter the character K after the >> prompt.' )
        IF (.NOT. STATUS) CALL LIB$SIGNAL(%VAL(STATUS))

1        STATUS = SMG$PUT_LINE ( DISPLAY1,
        'This character will not be echoed as you type it.' )
        IF (.NOT. STATUS) CALL LIB$SIGNAL(%VAL(STATUS))

1        STATUS = SMG$PUT_LINE ( DISPLAY1,
        'The terminal character equivalent of K is displayed.' )
        IF (.NOT. STATUS) CALL LIB$SIGNAL(%VAL(STATUS))

        STATUS = SMG$PUT_LINE ( DISPLAY1, ' ' )
        IF (.NOT. STATUS) CALL LIB$SIGNAL(%VAL(STATUS))

C+
C Call SMG$READ_KEYSTROKE to read a keystroke from the virtual
C pasteboard.
C-

        STATUS = SMG$READ_KEYSTROKE ( KEYBOARD1, TERM_CHAR, '>>', ,
1         DISPLAY1 )
        IF (.NOT. STATUS) CALL LIB$SIGNAL(%VAL(STATUS))

        STATUS = SMG$PUT_LINE ( DISPLAY1, ' ' )
        IF (.NOT. STATUS) CALL LIB$SIGNAL(%VAL(STATUS))

C+
C Use OTS$CVT_L_TI to convert the decimal value of TERM_CHAR to
C a decimal ASCII text string.
C-

        STATUS = OTS$CVT_L_TI ( TERM_CHAR, TEXT )
        IF (.NOT. STATUS) CALL LIB$SIGNAL(%VAL(STATUS))

        TEXT_OUTPUT = ' TERMINAL CHARACTER IS: ' // TEXT
```

SMG\$ Routines SMG\$READ_KEYSTROKE

```
C+
C Call SMG$PUT_LINE and SMG$PUT_CHARS to print the decimal
C ASCII text string.
C-

      STATUS = SMG$PUT_LINE ( DISPLAY1, TEXT_OUTPUT )
      IF (.NOT. STATUS) CALL LIB$SIGNAL(%VAL(STATUS))

      STATUS = SMG$PUT_CHARS ( DISPLAY1, TEXT, 7, 25 )
      IF (.NOT. STATUS) CALL LIB$SIGNAL(%VAL(STATUS))

      END
```

The output generated by this Fortran program is shown in Figure SMG-37.

Figure SMG-37 Output Generated by Fortran Program Calling SMG\$READ_KEYSTROKE

```
Enter the character K after the >> prompt.
This character will not be echoed as you type it.
The terminal character equivalent of K is displayed.

>>

      TERMINAL CHARACTER IS: 107
```

ZK-4129-GE

```
2. 1      OPTION TYPE=EXPLICIT

      !+
      ! This VAX BASIC program demonstrates the use of
      ! SMG$READ_KEYSTROKE to read a keystroke from the terminal.
      !

      DECLARE LONG kb_id, ret_status, term_code, I, timer
      EXTERNAL SUB LIB$SIGNAL( LONG BY VALUE )
      EXTERNAL SUB LIB$STOP( LONG BY VALUE )
      EXTERNAL LONG CONSTANT SS$_TIMEOUT

      %INCLUDE "$SMGDEF" %FROM %LIBRARY "SYS$LIBRARY:BASIC$STARLET"
```

SMG\$ Routines

SMG\$READ_KEYSTROKE

```
EXTERNAL LONG FUNCTION SMG$CREATE_VIRTUAL_KEYBOARD( LONG, STRING )
EXTERNAL LONG FUNCTION SMG$DELETE_VIRTUAL_KEYBOARD( LONG )
EXTERNAL LONG FUNCTION SMG$READ_KEYSTROKE( LONG, LONG, STRING, &
LONG, LONG )

!+
! Prompt the user for the timer value. A value of 0 will cause
! the type ahead buffer to be read.
!-

INPUT "Enter timer value (0 to read typeahead buffer): ";timer

!+
! Establish a SMG connection to SYS$INPUT. Signal any unexpected
! errors.
!-

ret_status = SMG$CREATE_VIRTUAL_KEYBOARD( kb_id, "SYS$INPUT:" )
IF (ret_status AND 1%) = 0% THEN
    CALL LIB$SIGNAL( ret_status )
END IF

!+
! Read a keystroke, tell the user what we found.
!-

ret_status = SMG$READ_KEYSTROKE( kb_id, term_code, , timer, )
IF (ret_status <> SS$_TIMEOUT) AND ((ret_status AND 1%) = 0%) THEN
    CALL LIB$SIGNAL( ret_status )
END IF

PRINT "term_code = ";term_code
SELECT term_code
    CASE 0 TO 31
        PRINT "You typed a control character"
    CASE 32 TO 127
        PRINT "You typed: ";CHR$(term_code)
    CASE SMG$K_TRM_PF1 TO SMG$K_TRM_PERIOD
        PRINT "You typed one of the keypad keys"
    CASE SMG$K_TRM_UP TO SMG$K_TRM_RIGHT
        PRINT "You typed one of the cursor positioning keys"
    CASE SMG$K_TRM_F6 TO SMG$K_TRM_F20
        PRINT "You typed one of the function keys"
    CASE SMG$K_TRM_FIND TO SMG$K_TRM_NEXT_SCREEN
        PRINT "You typed one of the editing keys"
    CASE SMG$K_TRM_TIMEOUT
        PRINT "You did not type a key fast enough"
    CASE ELSE
        PRINT "I'm not sure what key you typed"
END SELECT

!+
! Close the connection to SYS$INPUT, and signal any errors.
!-

ret_status = SMG$DELETE_VIRTUAL_KEYBOARD( kb_id )
IF (ret_status AND 1%) = 0% THEN
    CALL LIB$SIGNAL( ret_status )
END IF

END
```

SMG\$ Routines SMG\$READ_KEYSTROKE

This BASIC program reads a key and returns the **word-terminator-code** and the name of the keystroke entered. One sample of the commands entered and the output generated by this program is as follows:

```
$ RUN READ_KEY
Enter the timer value (0 to read type-ahead buffer): ? 9
term_code = 100
You typed: d
```

Note that, in this example, the user entered the keystroke “d” following the first prompt. The keystroke entered was not echoed.

SMG\$READ_LOCATOR

Read Locator Information

The Read Locator Information routine reads information from a DECwindows workstation terminal's locator device (such as a mouse or tablet).

Format

SMG\$READ_LOCATOR keyboard-id ,row-number ,column-number
,word-terminator-code [,timeout] [,parse-routine]

Returns

OpenVMS usage: cond_value
type: longword (unsigned)
access: write only
mechanism: by value

Arguments

keyboard-id

OpenVMS usage: identifier
type: longword (unsigned)
access: read only
mechanism: by reference

Keyboard identifier. The **keyboard-id** argument is the address of an unsigned longword containing the identifier of the desired virtual keyboard.

You can create a virtual keyboard by calling the SMG\$CREATE_VIRTUAL_KEYBOARD routine.

row-number

OpenVMS usage: word_unsigned
type: word (unsigned)
access: write only
mechanism: by reference

Row number to which the locator is pointing. The **row-number** argument is the address of an unsigned word that contains the row number of the virtual display at which the locator is pointing.

column-number

OpenVMS usage: word_unsigned
type: word (unsigned)
access: write only
mechanism: by reference

Column number to which the locator is pointing. The **column-number** argument is the address of an unsigned word that contains the column number of the virtual display at which the read is to be performed.

word-terminator-code

OpenVMS usage: word_unsigned
type: word (unsigned)
access: write only
mechanism: by reference

Locator terminator code. The **word-terminator-code** argument is the address of an unsigned word into which is written a code indicating what locator button terminated the read. Locator terminator codes are of the form SMG\$K_TRM_*keyname*. The key names are listed in Table 3-1.

timeout

OpenVMS usage: longword_signed
type: longword (signed)
access: read only
mechanism: by reference

Timeout count. The optional **timeout** argument is the address of a signed longword that contains a number of seconds. If specified, any character typed before the timeout is returned in the buffer.

parse-routine

OpenVMS usage: longword_unsigned
type: longword (signed)
access: read only
mechanism: by reference

Address of a user-supplied parse routine that is called to parse the locator input. The optional **parse-routine** argument is the address of an unsigned longword that contains the parse routine. If this argument is not specified, ANSI locator input is assumed.

For more information on the parse routine, see Call Format for a Parse Routine in the Description section.

Description

SMG\$READ_LOCATOR reads information from a DECwindows workstation terminal's locator device. (This routine does not read locator information from the VT300 series terminals.) A locator device is a mouse or a tablet. This routine returns the row and column specified by the locator, as well as the button pressed. This routine assumes the locator will respond with an ANSI response. If another format is used, you must specify the **parse-routine** argument with the address of a routine that is called to parse the locator response.

Call Format for a Parse Routine

The parse routine is called only if the **parse-routine** argument was specified in the SMG\$READ_LOCATOR argument list.

The calling format of a parse routine is as follows:

```
parse-routine keyboard-id ,response ,row ,column ,button
```

The parse routine should return a success status value (0 bit set), otherwise SMG\$READ_LOCATOR terminates without setting the row, column, or button parameters and returns this same status cvalue.

SMG\$ Routines

SMG\$READ_LOCATOR

Arguments

keyboard-id

OpenVMS usage: identifier
type: longword (unsigned)
access: read only
mechanism: by reference

Keyboard identifier. The **keyboard-id** argument is an unsigned longword containing the identifier of the desired virtual keyboard.

response

OpenVMS usage: char_string
type: character string
access: read only
mechanism: by descriptor

Locator response to be parsed. The **response** argument is the address of a descriptor pointing to the response string to be read.

row

OpenVMS usage: word_unsigned
type: word (unsigned)
access: write only
mechanism: by reference

Receives the row number to which the locator is pointing. The **row** argument is an unsigned word that contains the row number of the virtual display.

column

OpenVMS usage: word_unsigned
type: word (unsigned)
access: write only
mechanism: by reference

Receives the column number to which the locator is pointing. The **column** argument is an unsigned word that contains the column number of the virtual display.

button

OpenVMS usage: word_unsigned
type: word (unsigned)
access: write only
mechanism: by reference

Receives the button that was pressed. The **button** argument is an unsigned word that contains the button pressed. Returned value should be SMG\$SK_TRM_keyname.

Condition Values Returned

| | |
|--------------|-------------------------------|
| SS\$_NORMAL | Normal successful completion. |
| SMG\$_EOF | End of file. |
| SMG\$_INVARG | Invalid argument. |

SMG\$ Routines
SMG\$READ_LOCATOR

SMG\$_INVDIS_ID
SMG\$_WRONUMARG

Invalid **display-id**.
Wrong number of arguments.

SMG\$READ_STRING

Read String

The Read String routine reads a string from a virtual keyboard.

Format

```
SMG$READ_STRING keyboard-id ,resultant-string [,prompt-string]
                [,maximum-length] [,modifiers] [,timeout] [,terminator-set]
                [,resultant-length] [,word-terminator-code] [,display-id]
                [,initial-string] [,rendition-set] [,rendition-complement]
                [,terminator-string]
```

Returns

OpenVMS usage: cond_value
type: longword (unsigned)
access: write only
mechanism: by value

Arguments

keyboard-id

OpenVMS usage: identifier
type: longword (unsigned)
access: read only
mechanism: by reference

Specifies the virtual keyboard from which input is to be read. The **keyboard-id** argument is the address of an unsigned longword that contains the keyboard identifier.

The keyboard identifier is returned by SMG\$CREATE_VIRTUAL_KEYBOARD.

resultant-string

OpenVMS usage: char_string
type: character string
access: write only
mechanism: by descriptor

String into which the input line is written. The **resultant-string** argument is the address of a descriptor pointing to the string into which the text is written.

prompt-string

OpenVMS usage: char_string
type: character string
access: read only
mechanism: by descriptor

String used to prompt for the read operation. The **prompt-string** argument is the address of a descriptor pointing to the prompt string.

maximum-length

OpenVMS usage: longword_signed
type: longword (signed)
access: read only

mechanism: by reference

Specifies the maximum number of characters to be read. The **maximum-length** argument is the address of a signed longword that contains the maximum number of characters to be read. The maximum valid value for this argument is 512. If omitted, 512 is the default.

modifiers

OpenVMS usage: mask_longword
type: longword (unsigned)
access: read only
mechanism: by reference

Optional bit mask that specifies optional behavior. The **modifiers** argument is the address of an unsigned longword that contains the flag.

Valid values for **modifiers** are as follows:

| | |
|---------------------|--|
| TRM\$M_TM_CVTLOW | Converts lowercase characters to uppercase characters. |
| TRM\$M_TM_NOECHO | Characters entered are not echoed on the screen. |
| TRM\$M_TM_NOEDIT | Advanced editing is disabled for this read operation. |
| TRM\$M_TM_NORECALL | Line recall is disabled. |
| TRM\$M_TM_PURGE | Type-ahead buffer is purged before read is begun. |
| TRM\$M_TM_TRMNOECHO | Termination character, if any, is not displayed. |

The TRM\$ symbols are defined by the \$TRMDEF macro/module in system symbol libraries supplied by Compaq. See the terminal driver section of the *OpenVMS I/O User's Reference Manual* for more information on modifiers for read operations.

timeout

OpenVMS usage: longword_signed
type: longword (signed)
access: read only
mechanism: by reference

Specifies the number of seconds allowed between the time the prompt is issued and the completion of the input operation. The **timeout** argument is the address of a signed longword that contains the timeout value.

If **timeout** is specified, all characters typed before the expiration time or until a terminate key is entered are returned in **resultant-string**. If omitted, the input operation remains active until a terminator is typed.

terminator-set

OpenVMS usage: unspecified
type: unspecified
access: read only
mechanism: by descriptor, fixed length

Either a mask that specifies which characters are to be treated as terminators (short form) or a descriptor pointing to such a mask (long form). The **terminator-set** argument is the address of a descriptor pointing to the mask.

SMG\$ Routines

SMG\$READ_STRING

If you want to use terminators with ASCII values in the range 0 to 31, use the short form, which consists of two longwords. The first longword is zero, and the second longword is a terminator character bit mask. You create this mask by setting the bit that corresponds to the ASCII value of the desired terminator. For example, to specify that Ctrl/A (ASCII value 1) is a terminator, you set bit 1 in the **terminator-set** mask.

To use terminators with ASCII values outside the range 0 to 31, use the long form. First create a descriptor of this form:

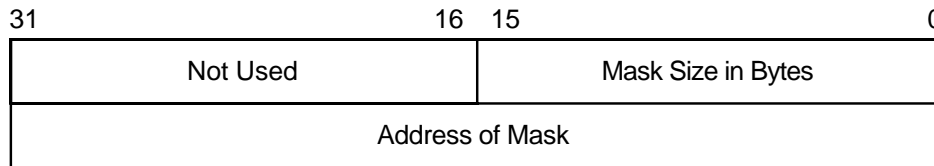

ZK-2004-GE

The mask itself has the same format as that of the short form; however, the long form allows the use of a more comprehensive set of terminator characters. For example, a mask size of 16 bytes allows any 7-bit ASCII character to be set as a terminator, while a mask size of 32 bytes allows any 8-bit character to be set as a terminator. Any mask size between 1 and 32 bytes is acceptable.

If the terminator mask is all zeros, there are no specified terminators. In that case, the read terminates when the number of characters specified in **maximum-length** has been transferred or when timeout is reached.

If the **terminator-set** argument is omitted, the set of terminators is the OpenVMS default terminator set. For more information, see the *OpenVMS I/O User's Reference Manual*.

resultant-length

OpenVMS usage: word_unsigned
type: word (unsigned)
access: write only
mechanism: by reference

Receives the number of characters read or the maximum size of **resultant-string**, whichever is less. The **resultant-length** argument is the address of an unsigned word into which is written the number of characters read or the maximum size.

word-terminator-code

OpenVMS usage: word_unsigned
type: word (unsigned)
access: write only
mechanism: by reference

Key terminator code. The **word-terminator-code** argument is an unsigned word into which is written a code indicating what character or key terminated the read. Key terminator codes are of the form `SMG$K_TRM_keyname`. The key names are listed in Table 3-1.

display-id

OpenVMS usage: identifier
type: longword (unsigned)
access: read only
mechanism: by reference

Display identifier. The **display-id** argument is the address of an unsigned longword that contains the display identifier. This argument is optional only if you are not using the Screen Management Facility's output routines.

If you are using the Screen Management Facility input and output routines, this argument specifies the virtual display in which the input is to occur. The virtual display specified must be pasted to the same pasteboard as specified by **keyboard-id** and must not be occluded. You cannot accept input from an occluded area of the virtual display.

In the case of multiple virtual displays, each virtual display has an associated virtual cursor position. At the same time, there is a single physical cursor position corresponding to the current location of the physical cursor. If the **display-id** argument is specified, the read begins at the current virtual cursor position in the specified virtual display. If **display-id** is omitted, the read begins in the current physical cursor position. Note that the length of the **prompt-string** plus the key entered is limited to the number of visible columns in the display.

Note

This virtual display must be pasted in column 1 and may not have any other virtual displays to its right. This restriction applies because otherwise the occurrence of a Ctrl/R or Ctrl/U would cause the entire line to be blanked, including any output to the right. To circumvent this restriction, you may use SMG\$REPAINT_LINE to repaint the line when a Ctrl/R or Ctrl/U is detected.

initial-string

OpenVMS usage: char_string
type: character string
access: read only
mechanism: by descriptor

Initial character string. The **initial-string** argument is the address of a descriptor pointing to the optional string that contains the initial characters of the field. The string is written to the display in the input area, as if it had been entered from the keyboard. It may be edited in the usual way (provided that TRM\$M_TM_NOEDIT is not set). It must be shorter than **maximum-length**, otherwise SMG\$READ_STRING returns immediately without accepting any keyboard input.

rendition-set

OpenVMS usage: mask_longword
type: longword (unsigned)
access: read only
mechanism: by reference

SMG\$ Routines

SMG\$READ_STRING

Attribute specifier. The optional **rendition-set** argument is the address of a longword bit mask in which each attribute set causes the corresponding attribute to be set in the display. The following attributes can be specified using the **rendition-set** argument:

| | |
|--------------------------------------|---|
| SMG\$M_BLINK | Displays blinking characters. |
| SMG\$M_BOLD | Displays characters in higher-than-normal intensity (bolded). |
| SMG\$M_REVERSE | Displays characters in reverse video; that is, using the opposite default rendition of the virtual display. |
| SMG\$M_UNDERLINE | Displays underlined characters. |
| SMG\$M_INVISIBLE | Specifies invisible characters; that is, the characters exist in the virtual display but do not appear on the pasteboard. |
| SMG\$M_USER1 through SMG\$M_USER8 | Displays user-defined attributes. |

The **display-id** argument must be specified when you use the **rendition-set** argument.

rendition-complement

OpenVMS usage: mask_longword
 type: longword (unsigned)
 access: read only
 mechanism: by reference

Attribute complement specifier. The optional **rendition-complement** argument is the address of a longword bit mask in which each attribute set causes the corresponding attribute to be complemented in the display. All of the attributes that can be specified with the **rendition-set** argument can be complemented with **rendition-complement**. The **display-id** argument must be specified when you use the **rendition-complement** argument.

The optional arguments **rendition-set** and **rendition-complement** let the user control the attributes of the virtual display in which the read is done. The **rendition-set** argument sets certain virtual display attributes, while **rendition-complement** complements these attributes. If the same bit is specified in both the **rendition-set** and **rendition-complement** parameters, **rendition-set** is evaluated first, followed by **rendition-complement**. By using these two parameters together, the user can control each virtual display attribute in a single procedure call. On a single-attribute basis, the user can cause the following transformations:

| Set | Complement | Action |
|-----|------------|--|
| 0 | 0 | Attribute set to default |
| 1 | 0 | Attribute on |
| 0 | 1 | Attribute set to complement of current setting |
| 1 | 1 | Attribute off |

terminator-string

OpenVMS usage: char_string
 type: character string
 access: write only
 mechanism: by descriptor

Characters that terminate I/O. The optional **terminator-string** argument is the address of a descriptor pointing to the character string containing the terminating characters. The **terminator-string** argument returns the actual terminating characters, not the key that was pressed to terminate the I/O.

Description

SMG\$READ_STRING returns a string of characters read from a virtual display. Note that display batching for both the pasteboard and the virtual display must be off when you use SMG\$READ_STRING.

The text read by SMG\$READ_STRING is saved for later recall with SMG\$READ_COMPOSED_LINE. Rendition applies to both the prompt (if there is one) and echoing of input characters.

Condition Values Returned

| | |
|------------------|---|
| SS\$ _NORMAL | Normal successful completion. |
| SS\$ _ABORT | I/O operation aborted during execution (by SMG\$CANCEL_INPUT). |
| SS\$ _CANCEL | I/O operation canceled while queued (by SMG\$CANCEL_INPUT). |
| SMG\$ _EOF | End of file. |
| SMG\$ _ILLBATFNC | Input not allowed from a batched display. |
| SMG\$ _INVARG | Invalid value for display-id was specified. |
| SMG\$ _INVCOL | Invalid column. The input occurs outside the virtual display. |
| SMG\$ _INVKBD_ID | Invalid keyboard-id . |
| SMG\$ _INVKTB_ID | Invalid key-table-id . |
| SMG\$ _INVMAXLEN | Maximum length specified was greater than 512. |
| SMG\$ _KBDIN_USE | On a second or subsequent read operation, multiple QIOs were attempted on the same channel. |
| SMG\$ _WRONUMARG | Wrong number of arguments. |

Any condition values returned by LIB\$SCOPY_R_DX, \$GET (except RMS\$ _EOF), or \$QIOW.

SMG\$ Routines

SMG\$READ_STRING

Examples

```
1. 1  OPTION TYPE=EXPLICIT

      !+
      ! This VAX BASIC program demonstrates the use of
      ! SMG$READ_STRING to read either a string,
      ! a control key, or a keypad key.
      !
      DECLARE LONG KB_ID, RET_STATUS, STR_LEN, TERM_CODE, MODIFIER, I, TIMER
      DECLARE STRING DATA_STR, TERM_SET
      EXTERNAL LONG CONSTANT IO$M_TIMED
      EXTERNAL LONG CONSTANT IO$M_NOECHO
      EXTERNAL LONG CONSTANT IO$M_NOFILTR
      EXTERNAL SUB LIB$SIGNAL( LONG BY VALUE )
      EXTERNAL SUB LIB$STOP( LONG BY VALUE )
      EXTERNAL LONG CONSTANT SS$TIMEOUT
      EXTERNAL LONG FUNCTION SMG$CREATE_VIRTUAL_KEYBOARD( LONG, STRING )
      EXTERNAL LONG FUNCTION SMG$DELETE_VIRTUAL_KEYBOARD( LONG )
      EXTERNAL LONG FUNCTION SMG$READ_STRING( LONG, STRING, STRING, &
      LONG, LONG, LONG, STRING, LONG, LONG )
      %INCLUDE "$SMGDEF" %FROM %LIBRARY "SYS$LIBRARY: BASIC$STARLET"

      !+
      ! Prompt the user for the timer value. A value of 0 will cause
      ! the type-ahead buffer to be read.
      !-

      INPUT "Enter timer value (0 to read type-ahead buffer): ";TIMER

      !+
      ! Tell SMG to use the timer value
      !-

      MODIFIER = IO$M_TIMED

      !+
      ! Establish a SMG connection to SYS$INPUT. Signal any unexpected
      ! errors.
      !-

      RET_STATUS = SMG$CREATE_VIRTUAL_KEYBOARD( KB_ID, "SYS$INPUT:" )
      IF (RET_STATUS AND 1%) = 0% THEN
          CALL LIB$SIGNAL( RET_STATUS )
      END IF

      !+
      ! Tell SMG to use any keystroke except a letter or number
      ! as a terminator to the input and perform the read.
      ! Signal any error except SS$TIMEOUT
      !-

      TERM_SET = STRING$( 4%, -1% ) + STRING$(12%, 0%)
      RET_STATUS = SMG$READ_STRING( KB_ID, DATA_STR, , , &
      MODIFIER, TIMER, TERM_SET, &
      STR_LEN, TERM_CODE )
      IF (RET_STATUS <> SS$TIMEOUT) AND ((RET_STATUS AND 1%) = 0%) THEN
          CALL LIB$SIGNAL( RET_STATUS )
      END IF

      !+
      ! All the data should come back as a terminator code, since any
      ! character can be a terminator.
      !-

      PRINT "data string = ";LEFT(DATA_STR, STR_LEN)
      PRINT "term_code = ";TERM_CODE
      SELECT TERM_CODE
```

SMG\$ Routines SMG\$READ_STRING

```
CASE 0 TO 31
  PRINT "You typed a control character"
CASE 32 TO 127
  PRINT "You typed: ";CHR$(TERM_CODE)
CASE SMG$K_TRM_PF1 TO SMG$K_TRM_PERIOD
  PRINT "You typed one of the keypad keys"
CASE SMG$K_TRM_UP TO SMG$K_TRM_RIGHT
  PRINT "You typed one of the cursor positioning keys"
CASE SMG$K_TRM_F6 TO SMG$K_TRM_F20
  PRINT "You typed one of the function keys"
CASE SMG$K_TRM_E1 TO SMG$K_TRM_E6
  PRINT "You typed one of the editing keys"
CASE SMG$K_TRM_TIMEOUT
  PRINT "You did not type a key fast enough"
CASE ELSE
  PRINT "I'm not sure what key you typed"
END SELECT

!+
! Close the connection to SYS$INPUT, and signal any errors.
!-

RET_STATUS = SMG$DELETE_VIRTUAL_KEYBOARD( KB_ID )
IF (RET_STATUS AND 1%) = 0% THEN
  CALL LIB$SIGNAL( RET_STATUS )
END IF

END
```

This BASIC example program demonstrates the use of SMG\$READ_STRING. One sample of the output generated by this program is as follows:

```
$ RUN READ_STRING
Enter timer value (0 to read type-ahead buffer): ? 5
  d
data string = d
term_code = 13
You typed a control character
```

- ```
C+
C This Fortran example program demonstrates how to use
C SMG$READ_STRING.
C
C This routine creates a virtual display and writes it to the pasteboard.
C Data is placed in the virtual display using SMG$PUT_CHARS.
C-

C+
C Include the SMG definitions. In particular, we want SMG$M_BORDER.
C-

 IMPLICIT INTEGER (A-Z)
 INCLUDE '($SMGDEF)'
 CHARACTER*20 TEXT

C+
C Create a virtual display with a border using SMG$CREATE_VIRTUAL_DISPLAY.
C-

 ROWS = 7
 COLUMNS = 50
```

## SMG\$ Routines

### SMG\$READ\_STRING

```
 STATUS = SMG$CREATE_VIRTUAL_DISPLAY
1 (ROWS, COLUMNS, DISPLAY1, SMG$M_BORDER)
 IF (.NOT. STATUS) CALL LIB$SIGNAL(%VAL(STATUS))

C+
C Use SMG$CREATE_PASTEBOARD to create the pasteboard.
C-

 STATUS = SMG$CREATE_PASTEBOARD (PASTE1)
 IF (.NOT. STATUS) CALL LIB$SIGNAL(%VAL(STATUS))

C+
C Create a virtual keyboard by calling SMG$CREATE_VIRTUAL_KEYBOARD.
C-

 STATUS = SMG$CREATE_VIRTUAL_KEYBOARD (KEYBOARD1)
 IF (.NOT. STATUS) CALL LIB$SIGNAL(%VAL(STATUS))

C+
C Use SMG$PASTE_VIRTUAL_DISPLAY to paste the virtual display
C at row 3, column 9.
C-

 STATUS = SMG$PASTE_VIRTUAL_DISPLAY (DISPLAY1, PASTE1, 3, 9)
 IF (.NOT. STATUS) CALL LIB$SIGNAL(%VAL(STATUS))

C+
C Read a string from the virtual pasteboard using SMG$READ_STRING.
C-

 STATUS = SMG$READ_STRING (KEYBOARD1,
1 TEXT, 'prompt', 20, , , , , , DISPLAY1)
 IF (.NOT. STATUS) CALL LIB$SIGNAL(%VAL(STATUS))

 END
```

The output generated by this Fortran program before the call to SMG\$READ\_STRING is shown in Figure SMG-38. The program is waiting for input. The cursor immediately follows the word "prompt."

**Figure SMG-38 Output Generated Before the Call to SMG\$READ\_STRING**



ZK-4138-GE

The output generated after the call to SMG\$READ\_STRING is shown in Figure SMG-39.

**SMG\$ Routines**  
**SMG\$READ\_STRING**

**Figure SMG-39 Output Generated After the Call to SMG\$READ\_STRING**



ZK-4140-GE



---

## SMG\$READ\_VERIFY

### Read and Verify a String

The Read and Verify a String routine reads a sequence of characters and verifies the sequence.

#### Format

```
SMG$READ_VERIFY keyboard-id ,resultant-string ,initial-string ,picture-string
 ,fill-character ,clear-character [,prompt-string]
 [,modifiers] [,timeout] [,placeholder-arg] [,initial-offset]
 [,word-terminator-code] [,display-id] [,alternate-echo-string]
 [,alternate-display-id] [,rendition-set] [,rendition-complement]
 [,input-length]
```

#### Returns

OpenVMS usage: cond\_value  
 type: longword (unsigned)  
 access: write only  
 mechanism: by value

#### Arguments

##### keyboard-id

OpenVMS usage: identifier  
 type: longword (unsigned)  
 access: read only  
 mechanism: by reference

Keyboard identifier. The **keyboard-id** argument is the address of an unsigned longword containing the identifier of the virtual keyboard from which to read.

The virtual keyboard is created by calling the SMG\$CREATE\_VIRTUAL\_KEYBOARD routine.

##### resultant-string

OpenVMS usage: char\_string  
 type: character string  
 access: write only  
 mechanism: by descriptor

Output string into which SMG\$READ\_VERIFY writes the characters that are read. The **resultant-string** argument is the address of a descriptor pointing to this output string.

##### initial-string

OpenVMS usage: char\_string  
 type: character string  
 access: read only  
 mechanism: by descriptor

Input string that contains the initial characters of the field. The **initial-string** argument is the address of a descriptor pointing to the input string.

## SMG\$ Routines

### SMG\$READ\_VERIFY

#### **picture-string**

OpenVMS usage: char\_string  
type: character string  
access: read only  
mechanism: by descriptor

String that contains a picture of what the field is to look like. The **picture-string** argument is the address of a descriptor pointing to the picture string.

For more information on the legal values for the picture string, see the terminal driver section of the *OpenVMS I/O User's Reference Manual*.

#### **fill-character**

OpenVMS usage: char\_string  
type: character string  
access: read only  
mechanism: by descriptor

Fill character. The **fill-character** argument is the address of a descriptor pointing to the string that contains the character to be used as a fill character in the **initial-string** argument.

#### **clear-character**

OpenVMS usage: char\_string  
type: character string  
access: read only  
mechanism: by descriptor

Clear character. The **clear-character** argument is the address of a descriptor pointing to the string that contains the character to be displayed for each occurrence of **fill-character** in **initial-string**.

#### **prompt-string**

OpenVMS usage: char\_string  
type: character string  
access: read only  
mechanism: by descriptor

Prompt string. The **prompt-string** argument is the address of a descriptor pointing to the string that SMG\$READ\_VERIFY uses as the prompt for the read operation. This is an optional argument.

#### **modifiers**

OpenVMS usage: mask\_longword  
type: longword (unsigned)  
access: read only  
mechanism: by reference

Modifiers. The **modifiers** argument is a longword bit mask that specifies optional behavior. The bits defined are the same as for the \$QIO item-list entry TRMS\_MODIFIERS. This is an optional argument.

Valid values for **modifiers** are as follows:

|                     |                                                        |
|---------------------|--------------------------------------------------------|
| TRM\$M_TM_AUTO_TAB  | Field is full when last character is entered.          |
| TRM\$M_TM_CVTLOW    | Converts lowercase characters to uppercase characters. |
| TRM\$M_TM_NOECHO    | Characters entered are not echoed on the screen.       |
| TRM\$M_TM_NOEDIT    | Advanced editing is disabled for this read operation.  |
| TRM\$M_TM_NORECALL  | Line recall is disabled.                               |
| TRM\$M_TM_PURGE     | Type-ahead buffer is purged before read is begun.      |
| TRM\$M_TM_R_JUST    | Input is right justified.                              |
| TRM\$M_TM_TRMNOECHO | Termination character, if any, is not displayed.       |

The TRM\$ symbols are defined by the \$TRMDEF macro/module in system symbol libraries supplied by Compaq. See the terminal driver section of the *OpenVMS I/O User's Reference Manual* for more information on modifiers for read operations.

**timeout**

OpenVMS usage: longword\_signed  
 type: longword (signed)  
 access: read only  
 mechanism: by reference

Timeout count. The **timeout** argument is the address of a signed longword that contains the timeout value. The **timeout** argument is optional. If **timeout** is specified, all characters typed in before the timeout or before a terminator is entered are returned in the buffer. If **timeout** is omitted, characters are returned in the buffer until a terminator is seen.

**placeholder-arg**

OpenVMS usage: unspecified  
 type: unspecified  
 access: read only  
 mechanism: unspecified

Placeholder argument. The OpenVMS terminal driver ignores this argument when performing a read-verify.

**initial-offset**

OpenVMS usage: longword\_signed  
 type: longword (signed)  
 access: read only  
 mechanism: by reference

Input string offset. The **initial-offset** argument is the address of a signed longword that contains the number of characters (from the **initial-string** argument) to output after the prompt before waiting for input.

**word-terminator-code**

OpenVMS usage: word\_unsigned  
 type: word (unsigned)  
 access: write only  
 mechanism: by reference

## SMG\$ Routines

### SMG\$READ\_VERIFY

Key terminator code. The **word-terminator-code** argument is an unsigned word into which SMG\$READ\_VERIFY writes a code indicating what character or key terminated the read. Key terminator codes are of the form SMG\$K\_TRM\_ *keyname*. The key names are listed in Table 3-1.

#### display-id

OpenVMS usage: identifier  
type: longword (unsigned)  
access: read only  
mechanism: by reference

Display identifier. The optional **display-id** argument is the address of an unsigned longword that contains the identifier of the virtual display in which the read is to be performed.

If **display-id** is specified, SMG\$READ\_VERIFY begins the read at the current virtual cursor position in that virtual display. If omitted, the read begins in the current physical cursor position. You cannot accept input from an occluded area of the virtual display.

In the case of multiple virtual displays, each virtual display has an associated virtual cursor position. At the same time, there is a single physical cursor position corresponding to the current location of the physical cursor. If the **display-id** argument is specified, the read begins at the current virtual cursor position in the specified virtual display. If omitted, the read begins in the current physical cursor position. Note that the length of the **prompt-string**, the **initial-offset**, and the string entered is limited to the number of visible columns in the display.

#### alternate-echo-string

OpenVMS usage: char\_string  
type: character string  
access: read only  
mechanism: by descriptor

Alternate echo string. The **alternate-echo-string** argument is a string that is printed after the first character is typed during the read operation. This is an optional argument.

#### alternate-display-id

OpenVMS usage: identifier  
type: longword (signed)  
access: read only  
mechanism: by reference

Alternate display identifier. The **alternate-display-id** is a signed longword containing the identifier of the virtual display in which the **alternate-echo-string** argument is to be printed. This is an optional argument. If specified, the output begins at the current virtual cursor position in that virtual display. If omitted, the value of the **display-id** argument is used as the default. If **display-id** is not specified, the output begins in the current physical cursor position.

**rendition-set**

OpenVMS usage: mask\_longword  
 type: longword (unsigned)  
 access: read only  
 mechanism: by reference

Attribute specifier. The optional **rendition-set** argument is the address of a longword bit mask in which each attribute set causes the corresponding attribute to be set in the display. The following attributes can be specified using the **rendition-set** argument:

|                                      |                                                                                                                           |
|--------------------------------------|---------------------------------------------------------------------------------------------------------------------------|
| SMG\$M_BLINK                         | Displays blinking characters.                                                                                             |
| SMG\$M_BOLD                          | Displays characters in higher-than-normal intensity.                                                                      |
| SMG\$M_REVERSE                       | Displays characters in reverse video; that is, using the opposite of the default rendition of the virtual display.        |
| SMG\$M_UNDERLINE                     | Displays underlined characters.                                                                                           |
| SMG\$M_INVISIBLE                     | Specifies invisible characters; that is, the characters exist in the virtual display but do not appear on the pasteboard. |
| SMG\$M_USER1 through<br>SMG\$M_USER8 | Displays user-defined attributes.                                                                                         |

The **display-id** argument must be specified when you use the **rendition-set** argument.

**rendition-complement**

OpenVMS usage: mask\_longword  
 type: longword (unsigned)  
 access: read only  
 mechanism: by reference

Attribute complement specifier. The optional **rendition-complement** argument is the address of a longword bit mask in which each attribute set causes the corresponding attribute to be complemented in the display. All attributes that can be specified with the **rendition-set** argument can be complemented with the **rendition-complement** argument. The **display-id** argument must be specified when you use the **rendition-complement** argument.

The optional arguments **rendition-set** and **rendition-complement** let the user control the attributes of the virtual display in which the read is done. The **rendition-set** argument sets certain virtual display attributes, while **rendition-complement** complements these attributes. If the same bit is specified in both the **rendition-set** and **rendition-complement** parameters, **rendition-set** is evaluated first, followed by **rendition-complement**. By using these two parameters together, the user can control each virtual display attribute in a single procedure call. On a single-attribute basis, the user can cause the transformations shown in the following table.

## SMG\$ Routines

### SMG\$READ\_VERIFY

| Set | Complement | Action                                         |
|-----|------------|------------------------------------------------|
| 0   | 0          | Attribute set to default                       |
| 1   | 0          | Attribute on                                   |
| 0   | 1          | Attribute set to complement of default setting |
| 1   | 1          | Attribute off                                  |

#### input-length

OpenVMS usage: word\_unsigned  
type: word (unsigned)  
access: write only  
mechanism: by reference

Number of characters entered by the user. The **input-length** argument is the address of an unsigned word containing this number.

### Description

SMG\$READ\_VERIFY reads a sequence of characters from the virtual keyboard specified and verifies the sequence against the picture string. It then returns characters read to the caller. The caller may also specify that a code indicating the terminator be returned. Rendition applies to both the prompt (if there is one) and echoing of input characters.

Note that display batching for both the pasteboard and the virtual display must be off when you use SMG\$READ\_VERIFY.

For additional information on read-verify operations and on use of the read-verify arguments, see the terminal driver section of the *OpenVMS I/O User's Reference Manual*.

### Condition Values Returned

|                  |                                                                                                                                                                                                                                                                                                                |
|------------------|----------------------------------------------------------------------------------------------------------------------------------------------------------------------------------------------------------------------------------------------------------------------------------------------------------------|
| SS\$ _NORMAL     | Normal successful completion.                                                                                                                                                                                                                                                                                  |
| SS\$ _ABORT      | I/O operation aborted during execution (by SMG\$CANCEL_INPUT).                                                                                                                                                                                                                                                 |
| SS\$ _CANCEL     | I/O operation canceled while queued (by SMG\$CANCEL_INPUT).                                                                                                                                                                                                                                                    |
| SMG\$ _DISREQ    | A call to SMG\$READ_VERIFY was made specifying right-justification; no <b>display-id</b> was specified, and the SCROLL_REVERSE sequence was not found for this terminal in TERMTABLE.EXE. Add the <b>display-id</b> argument to the SMG\$READ_VERIFY call or add the SCROLL_REVERSE sequence to TERMTABLE.EXE. |
| SMG\$ _EOF       | End of file.                                                                                                                                                                                                                                                                                                   |
| SMG\$ _INVCOL    | Invalid column specified.                                                                                                                                                                                                                                                                                      |
| SMG\$ _INVDIS_ID | Invalid <b>display-id</b> .                                                                                                                                                                                                                                                                                    |
| SMG\$ _INVKBD_ID | Invalid <b>keyboard-id</b> .                                                                                                                                                                                                                                                                                   |

**SMG\$ Routines**  
**SMG\$READ\_VERIFY**

|                 |                                                                                             |
|-----------------|---------------------------------------------------------------------------------------------|
| SMG\$_KBDIN_USE | On a second or subsequent read operation, multiple QIOs were attempted on the same channel. |
| SMG\$_LENMUSONE | Length of <b>fill-character</b> and <b>clear-character</b> must be 1.                       |
| SMG\$_LENNOTEQL | Length of <b>picture-string</b> and <b>initial-string</b> are not equal.                    |
| SMG\$_WRONUMARG | Wrong number of arguments.                                                                  |
| LIB\$_xxx       | Any error from LIB\$SCOPY_R_DX.                                                             |
| RMS\$_xxx       | Any error from \$GET (except RMS\$_EOF).                                                    |
| SS\$_xxx        | Any error from \$QIOW.                                                                      |

---

## SMG\$REMOVE\_LINE

### Remove a Line from a Virtual Display

The Remove a Line from a Virtual Display routine removes a line from a specified virtual display that was drawn with the SMG\$DRAW\_LINE or SMG\$DRAW\_RECTANGLE routines.

#### Format

SMG\$REMOVE\_LINE display-id ,start-row ,start-column ,end-row ,end-column

#### Returns

OpenVMS usage: cond\_value  
type: longword (unsigned)  
access: write only  
mechanism: by value

#### Arguments

##### display-id

OpenVMS usage: identifier  
type: longword (unsigned)  
access: read only  
mechanism: by reference

Specifies the virtual display from which the line is to be removed. The **display-id** argument is the address of an unsigned longword that contains the display identifier.

The display identifier is returned by SMG\$CREATE\_VIRTUAL\_DISPLAY.

##### start-row

OpenVMS usage: longword\_signed  
type: longword (signed)  
access: read only  
mechanism: by reference

Specifies the row at which to begin removing the line. The **start-row** argument is the address of a signed longword that contains the row number.

##### start-column

OpenVMS usage: longword\_signed  
type: longword (signed)  
access: read only  
mechanism: by reference

Specifies the column at which to begin removing the line. The **start-column** argument is the address of a signed longword that contains the column number.



**end-row**

OpenVMS usage: longword\_signed  
type: longword (signed)  
access: read only  
mechanism: by reference

Specifies the row at which the line to be removed ends. The **end-row** argument is the address of a signed longword that contains the row number.

**end-column**

OpenVMS usage: longword\_signed  
type: longword (signed)  
access: read only  
mechanism: by reference

Specifies the column at which the line to be removed ends. The **end-column** argument is the address of a signed longword that contains the column number.

**Description**

SMG\$REMOVE\_LINE removes a line drawn with SMG\$DRAW\_LINE or SMG\$DRAW\_RECTANGLE from a specified starting row and column to a specified ending row and column.

This routine erases the line you specify but preserves the line-drawing characters at any line intersection. The line-drawing characters are the terminal's line-drawing character set. If that is not available, the plus sign (+), minus sign (-), and vertical bar ( | ) characters are used.

**Condition Values Returned**

|                 |                                                                             |
|-----------------|-----------------------------------------------------------------------------|
| SS\$_NORMAL     | Normal successful completion.                                               |
| SMG\$_DIALINNOT | Diagonal line not allowed.                                                  |
| SMG\$_INVCOL    | Invalid column number. The specified column is outside the virtual display. |
| SMG\$_INVROW    | Invalid row number. The specified row is outside the virtual display.       |
| SMG\$_WRONUMARG | Wrong number of arguments.                                                  |

---

## SMG\$REPAINT\_LINE

### Repaint One or More Lines on the Current Pasteboard

The Repaint One or More Lines on the Current Pasteboard routine repaints a series of lines on the current pasteboard.

#### Format

SMG\$REPAINT\_LINE pasteboard-id ,start-row [,number-of-lines]

#### Returns

OpenVMS usage: cond\_value  
type: longword (unsigned)  
access: write only  
mechanism: by value

#### Arguments

##### pasteboard-id

OpenVMS usage: identifier  
type: longword (unsigned)  
access: read only  
mechanism: by reference

Pasteboard identifier. The **pasteboard-id** argument is the address of the pasteboard associated with the physical screen to be repainted.

##### start-row

OpenVMS usage: longword\_signed  
type: longword (signed)  
access: read only  
mechanism: by reference

Starting row number. The **start-row** argument is the address of the pasteboard row number to start repainting.

##### number-of-lines

OpenVMS usage: longword\_signed  
type: longword (signed)  
access: read only  
mechanism: by reference

Number of contiguous lines to repaint. The **number-of-lines** argument is the address of a signed longword containing the number of lines. This argument is optional. If not specified, the default is 1.

#### Description

SMG\$REPAINT\_LINE repaints a line or series of lines on the specified pasteboard based on its memory of what the pasteboard should look like. You should call SMG\$REPAINT\_LINE when you suspect that the pasteboard has been disrupted.

## SMG\$ Routines SMG\$REPAINT\_LINE

SMG\$REPAINT\_LINE has the added benefit of circumventing the restriction that the display you are working on must be pasted to column 1. (For further information on this restriction, refer to the description section of SMG\$READ\_STRING.

This routine should not be used if the line being repainted is double height.

One good use of SMG\$REPAINT\_LINE is to restore a line after entering a Ctrl/U or Ctrl/R to an input routine.

### Condition Values Signaled

|                 |                                |
|-----------------|--------------------------------|
| SS\$NORMAL      | Normal successful completion.  |
| SMG\$_INVPAS_ID | Invalid <b>pasteboard-id</b> . |

---

## SMG\$REPAINT\_SCREEN

### Repaint Current Pasteboard

The Repaint Current Pasteboard routine repaints the specified pasteboard after non-SMG\$ I/O has occurred.

#### Format

SMG\$REPAINT\_SCREEN pasteboard-id

#### Returns

OpenVMS usage: cond\_value  
type: longword (unsigned)  
access: write only  
mechanism: by value

#### Argument

**pasteboard-id**  
OpenVMS usage: identifier  
type: longword (unsigned)  
access: read only  
mechanism: by reference

Specifies the pasteboard to be repainted. The **pasteboard-id** argument is the address of an unsigned longword that contains the pasteboard identifier.

#### Description

SMG\$REPAINT\_SCREEN repaints the specified pasteboard. It is intended to be used when some outside agent (for example, a broadcast message) has disrupted the pasteboard.

#### Condition Values Returned

|                  |                                |
|------------------|--------------------------------|
| SS\$ _NORMAL     | Normal successful completion.  |
| SMG\$ _INVPAS_ID | Invalid <b>pasteboard-id</b> . |
| SMG\$ _WRONUMARG | Wrong number of arguments.     |

#### Example

```
C+
C This Fortran example program demonstrates
C the use of SMG$REPAINT_SCREEN.
C-

 IMPLICIT INTEGER (A-Z)
```

## SMG\$ Routines SMG\$REPAINT\_SCREEN

```
C+
C Create the virtual display by calling
C SMG$CREATE_VIRTUAL_DISPLAY. To create
C a border, we set BORDER = 1. No border
C would be BORDER = 0.
C-
 INCLUDE '($SMGDEF)'
 ROWS = 3
 COLUMNS = 50
 BORDER = 1

 STATUS = SMG$CREATE_VIRTUAL_DISPLAY
1 (ROWS, COLUMNS, DISPLAY1, BORDER)
 IF (.NOT. STATUS) CALL LIB$SIGNAL(%VAL(STATUS))

C+
C Create the pasteboard using SMG$CREATE_PASTEBOARD.
C-
 STATUS = SMG$CREATE_PASTEBOARD (PASTE1)
 IF (.NOT. STATUS) CALL LIB$SIGNAL(%VAL(STATUS))

C+
C Put data in the virtual display by calling SMG$PUT_CHARS.
C-
 STATUS = SMG$PUT_CHARS (DISPLAY1,
1 ' This virtual display has 3 rows and 50 columns.', 1, 1)
 IF (.NOT. STATUS) CALL LIB$SIGNAL(%VAL(STATUS))

 STATUS = SMG$PUT_CHARS (DISPLAY1,
1 ' This is a bordered virtual display.', 2, 1)
 IF (.NOT. STATUS) CALL LIB$SIGNAL(%VAL(STATUS))

 STATUS = SMG$PUT_CHARS (DISPLAY1,
1 ' SMG$PUT_CHARS puts data in this virtual display.', 3, 1)
 IF (.NOT. STATUS) CALL LIB$SIGNAL(%VAL(STATUS))

C+
C Call SMG$PASTE_VIRTUAL_DISPLAY to paste the virtual display.
C-
 STATUS = SMG$PASTE_VIRTUAL_DISPLAY (DISPLAY1, PASTE1, 4, 15)
 IF (.NOT. STATUS) CALL LIB$SIGNAL(%VAL(STATUS))

C+
C Mess up the screen with some FORTRAN output.
C-
 WRITE (6,*) 'Mess up the screen.'
 WRITE (6,*) 'More mess.'

C+
C Call SMG$REPAINT_SCREEN to repaint the screen.
C-
 STATUS = SMG$REPAINT_SCREEN (PASTE1)
 IF (.NOT. STATUS) CALL LIB$SIGNAL(%VAL(STATUS))

 END
```

The output generated by this Fortran program before the call to SMG\$REPAINT\_SCREEN is shown in Figure SMG-40.

**SMG\$ Routines**  
**SMG\$REPAINT\_SCREEN**

**Figure SMG-40 Output Generated by Fortran Program Calling SMG\$REPAINT\_SCREEN**

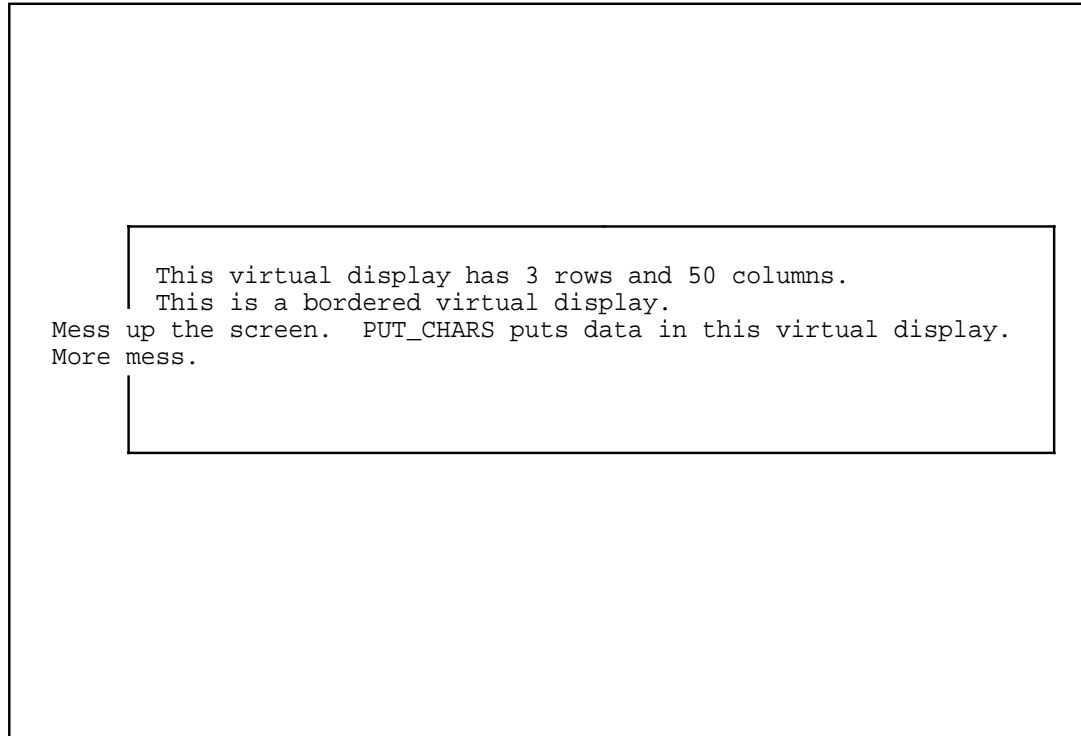

ZK-4136-GE

## SMG\$ Routines SMG\$REPAINT\_SCREEN

The output generated after the call to SMG\$REPAINT\_SCREEN is shown in Figure SMG-41.

**Figure SMG-41** Output Generated by Fortran Program Calling SMG\$REPAINT\_SCREEN

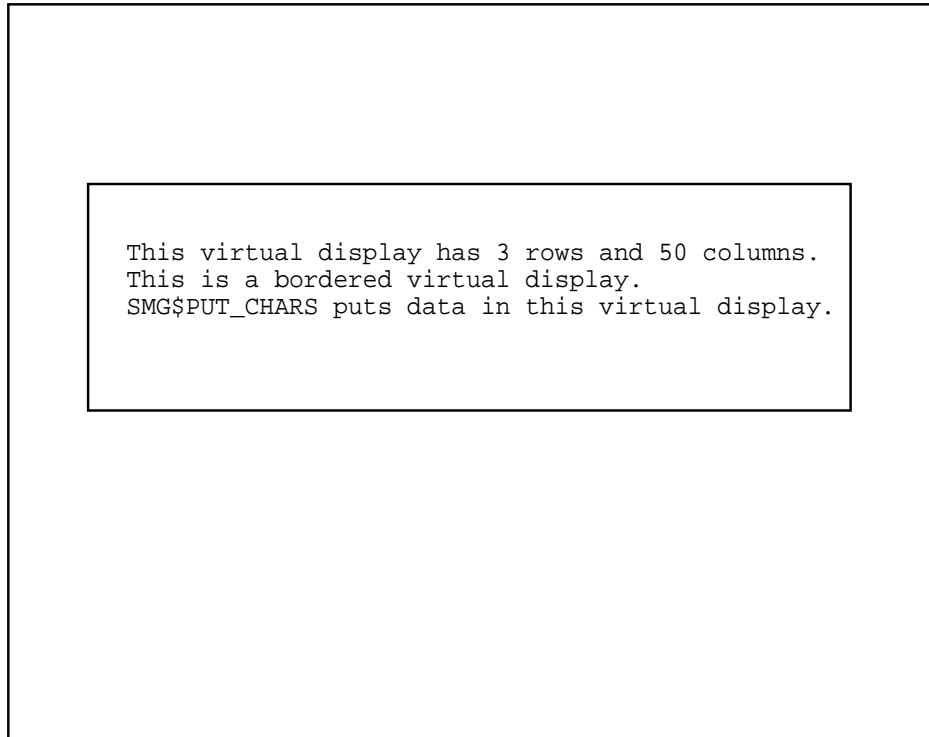

ZK-4137-GE

## SMG\$REPASTE\_VIRTUAL\_DISPLAY

### Repaste Virtual Display

The Repaste Virtual Display routine moves a virtual display to a new position on the pasteboard. The pasting order is not preserved.

#### Format

SMG\$REPASTE\_VIRTUAL\_DISPLAY display-id ,pasteboard-id ,pasteboard-row  
,pasteboard-column [,top-display-id]

#### Returns

OpenVMS usage: cond\_value  
type: longword (unsigned)  
access: write only  
mechanism: by value

#### Arguments

##### display-id

OpenVMS usage: identifier  
type: longword (unsigned)  
access: read only  
mechanism: by reference

Specifies the virtual display to be repasted. The **display-id** argument is the address of an unsigned longword that contains the display identifier.

The display identifier is returned by SMG\$CREATE\_VIRTUAL\_DISPLAY.

##### pasteboard-id

OpenVMS usage: identifier  
type: longword (unsigned)  
access: read only  
mechanism: by reference

Specifies the pasteboard on which the display is repasted. The **pasteboard-id** argument is the address of an unsigned longword that contains the pasteboard identifier.

##### pasteboard-row

OpenVMS usage: longword\_signed  
type: longword (signed)  
access: read only  
mechanism: by reference

Specifies the pasteboard row that is to contain row 1 of the specified virtual display. The **pasteboard-row** argument is the address of a signed longword that contains the pasteboard row.

##### pasteboard-column

OpenVMS usage: longword\_signed  
type: longword (signed)  
access: read only  
mechanism: by reference



Specifies the pasteboard column that is to contain column 1 of the specified virtual display. The **pasteboard-column** argument is the address of a signed longword that contains the pasteboard column.

**top-display-id**

OpenVMS usage: identifier  
 type: longword (unsigned)  
 access: read only  
 mechanism: by reference

Optional identifier of the virtual display under which **display-id** will be pasted. The **top-display-id** argument is the address of an unsigned longword containing the identifier of this virtual display. Note that the virtual display specified by **top-display-id** must already be pasted.

**Description**

SMG\$REPASTE\_VIRTUAL\_DISPLAY lets you move a virtual display to a new position on its pasteboard. This routine calls SMG\$UNPASTE\_VIRTUAL\_DISPLAY and SMG\$PASTE\_VIRTUAL\_DISPLAY. Note that this changes the pasting order. The unpasting and repasting operations use the SMG\$BEGIN\_PASTEBOARD\_UPDATE and SMG\$END\_PASTEBOARD\_UPDATE routines; thus, there is no effect on the screen until the repasting operation is complete.

Note that this routine may cause the virtual display to be at the top of the pasting order. To move a virtual display without changing its pasting order, use SMG\$MOVE\_VIRTUAL\_DISPLAY. If the optional argument **top-display-id** is specified, SMG\$REPASTE\_VIRTUAL\_DISPLAY pastes the virtual display being repasted under the virtual display specified by **top-display-id**. In this case, the virtual display specified by **top-display-id** must already be pasted.

**Condition Values Returned**

|                 |                                |
|-----------------|--------------------------------|
| SS\$_NORMAL     | Normal successful completion.  |
| SMG\$_INVDIS_ID | Invalid <b>display-id</b> .    |
| SMG\$_INVPAS_ID | Invalid <b>pasteboard-id</b> . |
| SMG\$_WRONUMARG | Wrong number of arguments.     |

**Example**

```
C+
C This Fortran example program demonstrates the use of
C SMG$REPASTE_VIRTUAL_DISPLAY and SMG$MOVE_VIRTUAL_DISPLAY.
C-

 IMPLICIT INTEGER (A-Z)

C+
C Include the SMG definitions. In particular, we want SMG$M_BORDER.
C-

 INCLUDE '($SMGDEF)'

C+
C Create a virtual display with a border by calling
C SMG$CREATE_VIRTUAL_DISPLAY.
C-
```

## SMG\$ Routines

### SMG\$REPASTE\_VIRTUAL\_DISPLAY

```
 ROWS = 3
 COLUMNS = 50

 STATUS = SMG$CREATE_VIRTUAL_DISPLAY
1 (ROWS, COLUMNS, DISPLAY1, SMG$M_BORDER)
 IF (.NOT. STATUS) CALL LIB$SIGNAL(%VAL(STATUS))

C+
C Call SMG$CREATE_PASTEBOARD to create the pasteboard.
C-

 STATUS = SMG$CREATE_PASTEBOARD (PASTE1)
 IF (.NOT. STATUS) CALL LIB$SIGNAL(%VAL(STATUS))

C+
C Put data in the virtual display using SMG$PUT_CHARS.
C-

 STATUS = SMG$PUT_CHARS (DISPLAY1,
1 ' This virtual display has 3 rows and 50 columns.', 1, 1)
 IF (.NOT. STATUS) CALL LIB$SIGNAL(%VAL(STATUS))

 STATUS = SMG$PUT_CHARS (DISPLAY1,
1 ' This is a bordered virtual display.', 2, 1)
 IF (.NOT. STATUS) CALL LIB$SIGNAL(%VAL(STATUS))

 STATUS = SMG$PUT_CHARS (DISPLAY1,
1 ' SMG$PUT_CHARS puts data in this virtual display.', 3, 1)
 IF (.NOT. STATUS) CALL LIB$SIGNAL(%VAL(STATUS))

C+
C Call SMG$PASTE_VIRTUAL_DISPLAY to paste the virtual display.
C-

 STATUS = SMG$PASTE_VIRTUAL_DISPLAY (DISPLAY1, PASTE1, 4, 15)
 IF (.NOT. STATUS) CALL LIB$SIGNAL(%VAL(STATUS))

C+
C Move the virtual display by calling SMG$MOVE_VIRTUAL_DISPLAY.
C-

 STATUS = SMG$MOVE_VIRTUAL_DISPLAY (DISPLAY1, PASTE1, 10, 5)
 IF (.NOT. STATUS) CALL LIB$SIGNAL(%VAL(STATUS))

C+
C Call SMG$REPASTE_VIRTUAL_DISPLAY to repaste the
C original virtual display as it was.
C-

 STATUS = SMG$REPASTE_VIRTUAL_DISPLAY (DISPLAY1, PASTE1, 4, 15)
 IF (.NOT. STATUS) CALL LIB$SIGNAL(%VAL(STATUS))

 END
```

The output generated by this Fortran program before the call to SMG\$MOVE\_VIRTUAL\_DISPLAY is shown in Figure SMG-42.

**SMG\$ Routines**  
**SMG\$REPASTE\_VIRTUAL\_DISPLAY**

**Figure SMG-42 Output Before the Call to SMG\$MOVE\_VIRTUAL\_DISPLAY**

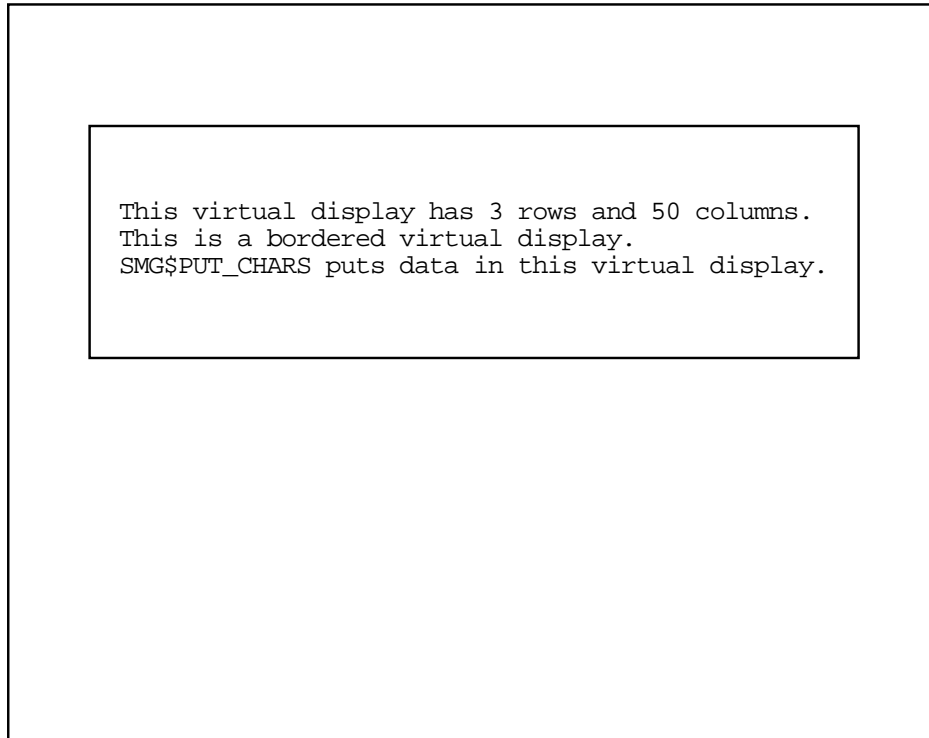

ZK-4139-GE

After the call to SMG\$MOVE\_VIRTUAL\_DISPLAY, the output is that shown in Figure SMG-43.

**SMG\$ Routines**  
**SMG\$REPASTE\_VIRTUAL\_DISPLAY**

**Figure SMG-43 Output Displayed After the Call to SMG\$MOVE\_VIRTUAL\_DISPLAY**

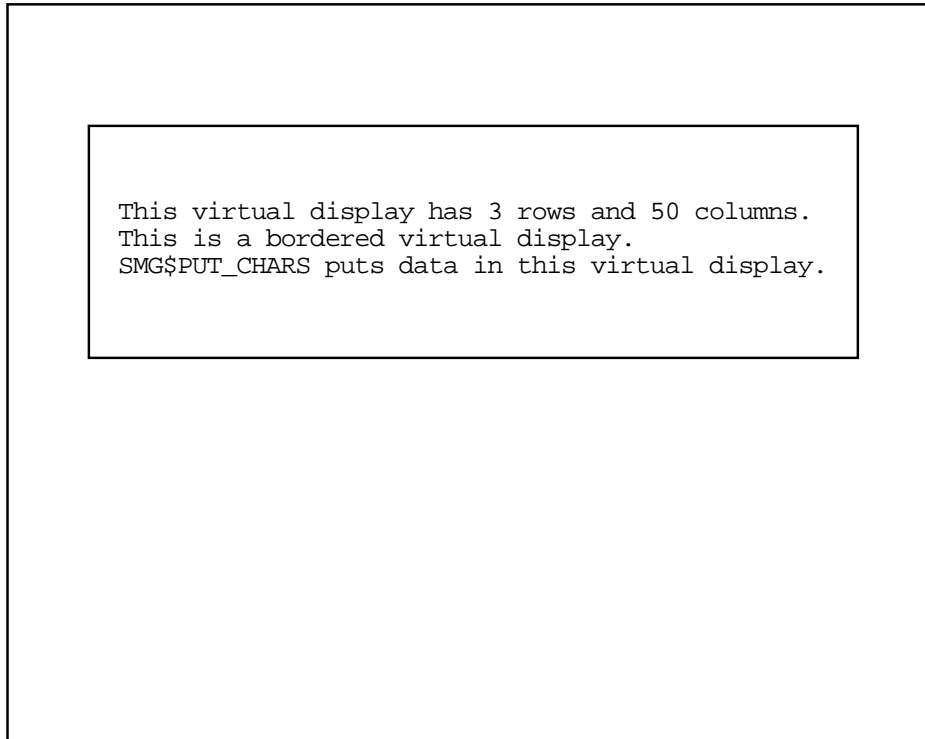

ZK-4141-GE

**Figure SMG-44 shows the final output displayed after the call to SMG\$REPASTE\_VIRTUAL\_DISPLAY.**

**SMG\$ Routines**  
**SMG\$REPASTE\_VIRTUAL\_DISPLAY**

**Figure SMG-44** Output Displayed After the Call to **SMG\$REPASTE\_VIRTUAL\_DISPLAY**

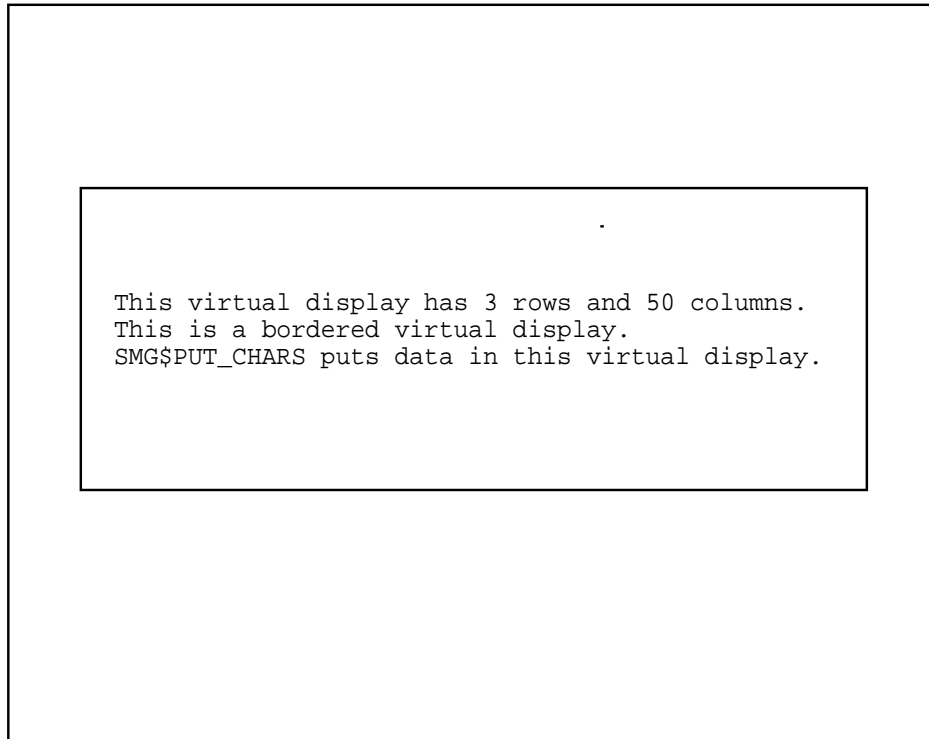

ZK-4130-GE

---

## SMG\$REPLACE\_INPUT\_LINE

### Replace Input Line

The Replace Input Line routine replaces the specified lines in the recall buffer with the specified string.

#### Format

SMG\$REPLACE\_INPUT\_LINE keyboard-id [,replace-string] [,line-count] [,flags]

#### Returns

OpenVMS usage: cond\_value  
type: longword (unsigned)  
access: write only  
mechanism: by value

#### Arguments

##### keyboard-id

OpenVMS usage: identifier  
type: longword (unsigned)  
access: read only  
mechanism: by reference

Keyboard identifier. The **keyboard-id** argument is the address of an unsigned longword containing the identifier of the virtual keyboard from which to read.

You create a virtual keyboard by calling the SMG\$CREATE\_VIRTUAL\_KEYBOARD routine.

##### replace-string

OpenVMS usage: char\_string  
type: character string  
access: read only  
mechanism: by descriptor

String that contains the line to be entered into the recall buffer. The **replace-string** argument is the address of a descriptor pointing to this string. The default is a null string, which removes the last line entered.

##### line-count

OpenVMS usage: byte\_unsigned  
type: byte (unsigned)  
access: read only  
mechanism: by reference

Number of lines to be replaced. The **line-count** argument is the address of an unsigned byte containing the number of lines to be replaced with **replace-string**. The default value for the **line-count** argument is 1 (the last line entered).

**flags**

OpenVMS usage: mask\_longword  
 type: longword (unsigned)  
 access: read only  
 mechanism: by reference

Specifies optional behavior. The **flags** argument is the address of an unsigned longword that contains the flag. There is one valid value:

|                      |                                                                                                                                                                                                                        |
|----------------------|------------------------------------------------------------------------------------------------------------------------------------------------------------------------------------------------------------------------|
| SMG\$M_KEEP_CONTENTS | The string specified by <b>replace-string</b> replaces the existing string specified by <b>line-count</b> . By using this flag in a loop, the line recall buffer can be preloaded with information by the application. |
|----------------------|------------------------------------------------------------------------------------------------------------------------------------------------------------------------------------------------------------------------|

**Description**

SMG\$REPLACE\_INPUT\_LINE replaces the requested lines in the recall buffer with the specified string. The remaining (**line-count** - 1) lines are deleted. This routine aids in processing line continuations.

**Condition Values Returned**

|                 |                               |
|-----------------|-------------------------------|
| SS\$NORMAL      | Normal successful completion. |
| SMG\$_INVKBD_ID | Invalid <b>keyboard-id</b> .  |
| SMG\$_WRONUMARG | Wrong number of arguments.    |
| LIB\$INSVIRMEM  | Insufficient virtual memory.  |

**Example**

```
!+
! This FORTRAN example uses the routine
! SMG$REPLACE_INPUT_LINE to concatenate
! the last two lines in the recall buffer.
!-

IMPLICIT INTEGER (A-Z)
INCLUDE '($SMGDEF)'
INCLUDE '($SMGMSG)'
CHARACTER*20 TEXT, TEXT1

WRITE (5,*) 'Enter number of lines to save.'
READ (5,*) R

S = SMG$CREATE_PASTEBOARD(PBID)
IF (.NOT. S) CALL LIB$STOP(%VAL(S))
S = SMG$CREATE_VIRTUAL_DISPLAY(22,70,DID,SMG$M_BORDER)
IF (.NOT. S) CALL LIB$STOP(%VAL(S))
S = SMG$CREATE_VIRTUAL_KEYBOARD(KBID,,,R)
IF (.NOT. S) CALL LIB$STOP(%VAL(S))
S = SMG$PUT_LINE(DID,'Enter lines of text:')
IF (.NOT. S) CALL LIB$STOP(%VAL(S))
S = SMG$PASTE_VIRTUAL_DISPLAY(DID,PBID,2,2)
IF (.NOT. S) CALL LIB$STOP(%VAL(S))
```

## SMG\$ Routines

### SMG\$REPLACE\_INPUT\_LINE

```
!+
! Read in lines of text.
!-
DO 10 I = 1,R
 S = SMG$READ_COMPOSED_LINE(KBID,,TEXT,'Example>',,DID)
 IF (.NOT. S) CALL LIB$STOP(%VAL(S))
 10 CONTINUE

!+
! Recall last two lines in the buffer.
!-
S = SMG$RETURN_INPUT_LINE(KBID,TEXT,,1,LEN)
IF (.NOT. S) CALL LIB$STOP(%VAL(S))
S = SMG$RETURN_INPUT_LINE(KBID,TEXT1,,2,LEN1)
IF (.NOT. S) CALL LIB$STOP(%VAL(S))
TEXT(LEN:20) = TEXT1(1:LEN1)

!+
! Concatenate them and replace the last two
! lines in the buffer with the new line.
!-
S = SMG$REPLACE_INPUT_LINE(KBID,TEXT,2)
IF (.NOT. S) CALL LIB$STOP(%VAL(S))

!+
! Recall the last line which is now the
! concatenated line.
!-
S = SMG$RETURN_INPUT_LINE(KBID,TEXT,,1)
IF (.NOT. S) CALL LIB$STOP(%VAL(S))

S = SMG$PUT_LINE(DID,'**** The last line of text is:')
IF (.NOT. S) CALL LIB$STOP(%VAL(S))
S = SMG$PUT_LINE(DID,TEXT)
IF (.NOT. S) CALL LIB$STOP(%VAL(S))

END
```

One sample of the output generated by this Fortran program is as follows:

```
$ RUN REPLACE
Enter number of lines to save.
 3
Enter lines of text:
Example> PASTEBOARD
Example> DISPLAY
Example> KEYBOARD
****The last line of text is:
KEYBOARDDISPLAY
```



---

## SMG\$RESTORE\_PHYSICAL\_SCREEN

### Restore Physical Pasteboard

The Restore Physical Pasteboard routine rewrites the pasteboard image as it was at the time the SMG\$SAVE\_PHYSICAL\_SCREEN routine was called.

#### Format

SMG\$RESTORE\_PHYSICAL\_SCREEN pasteboard-id ,display-id

#### Returns

OpenVMS usage: cond\_value  
type: longword (unsigned)  
access: write only  
mechanism: by value

#### Arguments

##### pasteboard-id

OpenVMS usage: identifier  
type: longword (unsigned)  
access: read only  
mechanism: by reference

Specifies the pasteboard to be restored. The **pasteboard-id** argument is the address of an unsigned longword that contains the pasteboard identifier.

The pasteboard identifier is returned by the SMG\$CREATE\_PASTEBOARD routine.

##### display-id

OpenVMS usage: identifier  
type: longword (unsigned)  
access: read only  
mechanism: by reference

Specifies the virtual display created by the SMG\$SAVE\_PHYSICAL\_SCREEN routine. The **display-id** argument is the address of an unsigned longword that contains this display identifier.

#### Description

SMG\$RESTORE\_PHYSICAL\_SCREEN reproduces the pasteboard image saved by the SMG\$SAVE\_PHYSICAL\_SCREEN routine. You must pass the **display-id** returned by the SMG\$SAVE\_PHYSICAL\_SCREEN routine to the SMG\$RESTORE\_PHYSICAL\_SCREEN routine. Note that when performing multiple calls to SMG\$SAVE\_PHYSICAL\_SCREEN and SMG\$RESTORE\_PHYSICAL\_SCREEN, the calls must be performed in a nested fashion; that is, the last pasteboard saved must be the first one restored.

**SMG\$ Routines**  
**SMG\$RESTORE\_PHYSICAL\_SCREEN**

**Condition Values Returned**

|                 |                                |
|-----------------|--------------------------------|
| SS\$_NORMAL     | Normal successful completion.  |
| SMG\$_INVDIS_ID | Invalid <b>display-id</b> .    |
| SMG\$_INVPAS_ID | Invalid <b>pasteboard-id</b> . |

---

## SMG\$RETURN\_CURSOR\_POS

### Return Cursor Position

The Return Cursor Position routine returns the current virtual cursor position in a specified virtual display.

#### Format

SMG\$RETURN\_CURSOR\_POS display-id ,start-row ,start-column

#### Returns

OpenVMS usage: cond\_value  
type: longword (unsigned)  
access: write only  
mechanism: by value

#### Arguments

##### display-id

OpenVMS usage: identifier  
type: longword (unsigned)  
access: read only  
mechanism: by reference

Specifies the virtual display whose current virtual cursor position you are requesting. The **display-id** argument is the address of an unsigned longword that contains the display identifier.

The display identifier is returned by SMG\$CREATE\_VIRTUAL\_DISPLAY.

##### start-row

OpenVMS usage: longword\_signed  
type: longword (signed)  
access: write only  
mechanism: by reference

Receives the virtual cursor's current row position within the specified virtual display. The **start-row** argument is the address of a signed longword into which is written the current row position.

##### start-column

OpenVMS usage: longword\_signed  
type: longword (signed)  
access: write only  
mechanism: by reference

Receives the virtual cursor's current column position within the specified virtual display. The **start-column** argument is the address of a signed longword into which is written the current column position.

## SMG\$ Routines

### SMG\$RETURN\_CURSOR\_POS

#### Description

SMG\$RETURN\_CURSOR\_POS returns the virtual cursor's current row and column positions in a specified virtual display.

#### Condition Values Returned

|                |                               |
|----------------|-------------------------------|
| SS\$NORMAL     | Normal successful completion. |
| SMG\$INVDIS_ID | Invalid <b>display-id</b> .   |
| SMG\$WRONUMARG | Wrong number of arguments.    |

## SMG\$RETURN\_INPUT\_LINE

### Return Input Line

The Return Input Line routine returns to the caller the requested line from the recall buffer. This line is retrieved either by matching it with a specified string or by specifying the appropriate line number.

#### Format

```
SMG$RETURN_INPUT_LINE keyboard-id ,resultant-string [,match-string]
 [,byte-integer-line-number] [,resultant-length]
```

#### Returns

OpenVMS usage: cond\_value  
 type: longword (unsigned)  
 access: write only  
 mechanism: by value

#### Arguments

##### keyboard-id

OpenVMS usage: identifier  
 type: longword (unsigned)  
 access: read only  
 mechanism: by reference

Keyboard identifier. The **keyboard-id** argument is the address of an unsigned longword containing the identifier of the virtual keyboard from which to read.

The virtual keyboard is created by calling the SMG\$CREATE\_VIRTUAL\_KEYBOARD routine.

##### resultant-string

OpenVMS usage: char\_string  
 type: character string  
 access: write only  
 mechanism: by descriptor

String into which is written the complete recalled line. The **resultant-string** argument is the address of a descriptor pointing to this string.

##### match-string

OpenVMS usage: char\_string  
 type: character string  
 access: read only  
 mechanism: by descriptor

Match string to be used when searching for the line to be recalled. The optional **match-string** argument is the address of a descriptor pointing to this match string. The search begins with the last line typed.

##### byte-integer-line-number

OpenVMS usage: byte\_unsigned  
 type: byte (unsigned)  
 access: read only

## SMG\$ Routines

### SMG\$RETURN\_INPUT\_LINE

mechanism: by reference

Line number to be used when searching for the line to be recalled. The optional **byte-integer-line-number** argument is the address of an unsigned byte containing the number of the line to be recalled. The last line typed is line number 1.

#### resultant-length

OpenVMS usage: word\_unsigned  
type: word (unsigned)  
access: write only  
mechanism: by reference

Length of the **resultant-string** string. The optional **resultant-length** argument is the address of an unsigned word containing either the number of characters read or the maximum length of **resultant-string**, whichever is less.

## Description

SMG\$RETURN\_INPUT\_LINE returns to the caller the specified line in the recall buffer. This routine aids in an implementation similar to the DCL command RECALL.

If you specify the **match-string** argument, SMG\$RETURN\_INPUT\_LINE searches for and returns the line that matches the specified string. If you specify the **byte-integer-line-number** argument, SMG\$RETURN\_INPUT\_LINE returns the line that corresponds to the specified line number. If you specify both **match-string** and **byte-integer-line-number**, SMG\$\_INVARG is returned. If you specify **match-string** and a match is not made, SMG\$\_LINNOTFND is returned.

## Condition Values Returned

|                 |                                 |
|-----------------|---------------------------------|
| SS\$_NORMAL     | Normal successful completion.   |
| SMG\$_INVARG    | Invalid argument.               |
| SMG\$_INVKBD_ID | Invalid <b>keyboard-id</b> .    |
| SMG\$_LINNOTFND | Matching line was not found.    |
| SMG\$_WRONUMARG | Wrong number of arguments.      |
| LIB\$_xxx       | Any error from LIB\$SCOPY_R_DX. |

## Example

```
!+
! This FORTRAN example uses the routine
! SMG$RETURN_INPUT_LINE to implement a
! RECALL/ALL command.
!-

IMPLICIT INTEGER (A-Z)
INCLUDE '($SMGDEF)'
INCLUDE '($SMGMSG)'
CHARACTER*20 TEXT

WRITE (5,*) 'Enter number of lines to save.'
READ (5,*) R
```

## SMG\$ Routines SMG\$RETURN\_INPUT\_LINE

```
S = SMG$CREATE_PASTEBOARD(PBID)
IF (.NOT. S) CALL LIB$STOP(%VAL(S))
S = SMG$CREATE_VIRTUAL_DISPLAY(22,70,DID,SMG$M_BORDER)
IF (.NOT. S) CALL LIB$STOP(%VAL(S))
S = SMG$CREATE_VIRTUAL_KEYBOARD(KBID,,,,R)
IF (.NOT. S) CALL LIB$STOP(%VAL(S))
S = SMG$PUT_LINE(DID,'Enter lines of text:')
IF (.NOT. S) CALL LIB$STOP(%VAL(S))
S = SMG$PASTE_VIRTUAL_DISPLAY(DID,PBID,2,2)
IF (.NOT. S) CALL LIB$STOP(%VAL(S))

!+
! Read in lines of text.
!-
DO 10 I = 1,R
 S = SMG$READ_COMPOSED_LINE(KBID,,TEXT,'Example>',,DID)
 IF (.NOT. S) CALL LIB$STOP(%VAL(S))
 10 CONTINUE

S = SMG$PUT_LINE(DID,'**** The lines of text are:')
IF (.NOT. S) CALL LIB$STOP(%VAL(S))
!+
! Recall all lines in the buffer.
!-
DO 30 N = 1,R
 S = SMG$RETURN_INPUT_LINE(KBID,TEXT,,N)
 IF (.NOT. S) CALL LIB$STOP(%VAL(S))
 S = SMG$PUT_LINE(DID,TEXT)
 IF (.NOT. S) CALL LIB$STOP(%VAL(S))
 30 CONTINUE

!+
! Recall the line containing 'fox'
!-
S = SMG$PUT_LINE(DID,'**** The line containing "fox" is:',2)
IF (.NOT. S) CALL LIB$STOP(%VAL(S))
S = SMG$RETURN_INPUT_LINE(KBID,TEXT,'FOX')
IF (S.EQ.SMG$_LINNOTFND) TEXT = 'None found!'
S = SMG$PUT_LINE(DID,TEXT)
IF (.NOT. S) CALL LIB$STOP(%VAL(S))

END
```

One sample of the output generated by this Fortran program is as follows:

```
$ RUN RETURN
Enter number of lines to save.
 3
Enter lines of text:
Example> PASTEBOARD
Example> DISPLAY
Example> KEYBOARD
****The lines of text are:
KEYBOARD
DISPLAY
PASTEBOARD
****The line containing "fox" is:

None found!
```

## SMG\$RING\_BELL

### Ring the Terminal Bell or Buzzer

The Ring the Terminal Bell or Buzzer routine sounds the terminal bell or buzzer.

#### Format

SMG\$RING\_BELL display-id [,number-of-times]

#### Returns

OpenVMS usage: cond\_value  
type: longword (unsigned)  
access: write only  
mechanism: by value

#### Arguments

**display-id**  
OpenVMS usage: identifier  
type: longword (unsigned)  
access: read only  
mechanism: by reference

Specifies the virtual display for which the bell or buzzer sounds. The **display-id** argument is the address of an unsigned longword that contains the display identifier.

The display identifier is returned by SMG\$CREATE\_VIRTUAL\_DISPLAY.

**number-of-times**  
OpenVMS usage: longword\_signed  
type: longword integer (signed)  
access: read only  
mechanism: by reference

Specifies the number of times the bell or buzzer is sounded. The **number-of-times** argument is the address of a signed longword integer that contains the number of times the bell or buzzer is sounded. If **number-of-times** is omitted, 1 is used.

#### Description

SMG\$RING\_BELL sounds the bell or buzzer on each pasteboard to which the specified virtual display is pasted. The bell or buzzer sounds the number of times specified; the default number of times is 1.

#### Condition Values Returned

SS\$NORMAL Normal successful completion.  
SMG\$INVDIS\_ID Invalid **display-id**.

Any condition values returned by \$QIOW, LIB\$GET\_VM, LIB\$FREE\_VM.



---

## SMG\$SAVE\_PHYSICAL\_SCREEN

### Save Physical Screen

The Save Physical Screen routine saves the contents of the pasteboard so that a later call to SMG\$RESTORE\_PHYSICAL\_SCREEN can restore it.

#### Format

```
SMG$SAVE_PHYSICAL_SCREEN pasteboard-id ,display-id [,desired-start-row]
 [,desired-end-row]
```

#### Returns

OpenVMS usage: cond\_value  
type: longword (unsigned)  
access: write only  
mechanism: by value

#### Arguments

##### **pasteboard-id**

OpenVMS usage: identifier  
type: longword (unsigned)  
access: read only  
mechanism: by reference

Specifies the pasteboard whose contents are to be saved. The **pasteboard-id** argument is the address of an unsigned longword that contains the pasteboard identifier.

##### **display-id**

OpenVMS usage: identifier  
type: longword (unsigned)  
access: write only  
mechanism: by reference

Receives the display identifier of the display created to contain the contents of the specified pasteboard. The **display-id** argument is the address of an unsigned longword into which the display identifier is written.

The display identifier must be passed to the SMG\$RESTORE\_PHYSICAL\_SCREEN routine to restore the saved information.

##### **desired-start-row**

OpenVMS usage: longword\_signed  
type: longword (signed)  
access: read only  
mechanism: by reference

Specifies the first row to be saved. The **desired-start-row** argument is the address of a signed longword that contains the row number. If **desired-start-row** is omitted, row 1 of the pasteboard is used.

## SMG\$ Routines

### SMG\$SAVE\_PHYSICAL\_SCREEN

#### **desired-end-row**

OpenVMS usage: longword\_signed  
type: longword (signed)  
access: read only  
mechanism: by reference

Specifies the last row to be saved. The **desired-end-row** argument is the address of a signed longword that contains the row number. If **desired-end-row** is omitted, the last row of the pasteboard is used.

## Description

SMG\$SAVE\_PHYSICAL\_SCREEN blanks the screen by creating a virtual display that is as wide as the specified pasteboard and as high as specified by the **desired-start-row** and **desired-end-row** arguments. If these two arguments are omitted, the created virtual display is as high as the specified pasteboard. The information saved — that is, the pasteboard image — can be restored by calling the SMG\$RESTORE\_PHYSICAL\_SCREEN routine. When performing multiple calls to SMG\$SAVE\_PHYSICAL\_SCREEN and SMG\$RESTORE\_PHYSICAL\_SCREEN, the calls must be performed in a nested order; that is, the last pasteboard saved must be the first one restored, and so on.

These routines are useful when calling a procedure that may send output to the screen without using the Screen Management Facility. Before calling such a procedure, you save the pasteboard image with SMG\$SAVE\_PHYSICAL\_SCREEN. After the procedure executes, you restore the pasteboard image with SMG\$RESTORE\_PHYSICAL\_SCREEN.

Note that the saved region must encompass at least two rows. When you use SMG\$SAVE\_PHYSICAL\_SCREEN on a terminal that does not support scrolling regions, you must save and restore the entire pasteboard.

## Condition Values Returned

|                 |                                                                       |
|-----------------|-----------------------------------------------------------------------|
| SS\$_NORMAL     | Normal successful completion.                                         |
| SMG\$_INVPAS_ID | Invalid <b>pasteboard-id</b> .                                        |
| SMG\$_INVROW    | Invalid row, or range specified does not encompass at least two rows. |
| SMG\$_WRONUMARG | Wrong number of arguments.                                            |
| LIB\$_INSVIRMEM | Insufficient virtual memory.                                          |

---

## SMG\$SAVE\_VIRTUAL\_DISPLAY

### Save the Virtual Display to a File

The Save the Virtual Display to a File routine saves the contents of a virtual display and stores it in a file.

#### Format

SMG\$SAVE\_VIRTUAL\_DISPLAY display-id [,filespec]

#### Returns

OpenVMS usage: cond\_value  
type: longword (unsigned)  
access: write only  
mechanism: by value

#### Arguments

##### display-id

OpenVMS usage: identifier  
type: longword (unsigned)  
access: read only  
mechanism: by reference

Specifies the virtual display to be saved. The **display-id** argument is the address of an unsigned longword that contains the display identifier.

The display identifier is returned by SMG\$CREATE\_VIRTUAL\_DISPLAY.

##### filespec

OpenVMS usage: char\_string  
type: character string  
access: read only  
mechanism: by descriptor

String containing the file specification of the file in which the specified virtual display is saved. The **filespec** argument is the address of a descriptor pointing to the character string containing the file specification.

A new file is created each time this routine is called. If **filespec** is omitted, the default file specification is SMGDISPLY.DAT.

#### Description

SMG\$SAVE\_VIRTUAL\_DISPLAY saves the contents of a virtual display and stores it in a nonprintable file. The text, renditions, and all attributes necessary to reconstruct the virtual display are saved. Menu, viewport, and subprocess context are not saved. The SMG\$LOAD\_VIRTUAL\_DISPLAY routine restores the virtual display.

**SMG\$ Routines**  
**SMG\$SAVE\_VIRTUAL\_DISPLAY**

**Condition Values Returned**

SS\$\_NORMAL

SMG\$\_INVDIS\_ID

RMS\$\_xxxx

Normal successful completion.

Invalid **display-id**.

Any error returned by \$OPEN, \$CONNECT,  
\$PUT, \$CLOSE.

---

## SMG\$SCROLL\_DISPLAY\_AREA

### Scroll Display Area

The Scroll Display Area routine scrolls a rectangular region of a virtual display.

#### Format

SMG\$SCROLL\_DISPLAY\_AREA display-id [,start-row] [,start-column] [,height]  
[,width] [,direction] [,count]

#### Returns

OpenVMS usage: cond\_value  
type: longword (unsigned)  
access: write only  
mechanism: by value

#### Arguments

##### display-id

OpenVMS usage: identifier  
type: longword (unsigned)  
access: read only  
mechanism: by reference

Specifies the virtual display in which scrolling takes place. The **display-id** argument is the address of an unsigned longword that contains the display identifier.

The display identifier is returned by SMG\$CREATE\_VIRTUAL\_DISPLAY.

##### start-row

OpenVMS usage: longword\_signed  
type: longword (signed)  
access: read only  
mechanism: by reference

Specifies the first row of the scrolling region. The **start-row** argument is the address of a signed longword that contains the starting row.

If **start-row** is omitted, row 1 of the specified virtual display is used.

##### start-column

OpenVMS usage: longword\_signed  
type: longword (signed)  
access: read only  
mechanism: by reference

Specifies the first column of the scrolling region. The **start-column** argument is the address of a signed longword that contains the starting column.

If omitted, column 1 of the specified virtual display is used.

##### height

OpenVMS usage: longword\_signed  
type: longword (signed)  
access: read only

## SMG\$ Routines

### SMG\$SCROLL\_DISPLAY\_AREA

mechanism: by reference

Specifies the number of rows in the scrolling region. The **height** argument is the address of a signed longword that contains the number of rows.

If omitted, this value defaults to either the height of the virtual scrolling region (if one has been explicitly set with SMG\$SET\_DISPLAY\_SCROLL\_REGION) or the height of the specified virtual display.

When scrolling a portion of a virtual display that contains double-height, double-width (highwide) characters, it is recommended that you scroll the display an even number of times.

#### width

OpenVMS usage: longword\_signed  
type: longword (signed)  
access: read only  
mechanism: by reference

Specifies the number of columns in the scrolling region. The **width** argument is the address of a signed longword that contains the number of columns.

If omitted, this value defaults to the width of the specified virtual display.

#### direction

OpenVMS usage: mask\_longword  
type: longword (unsigned)  
access: read only  
mechanism: by reference

Specifies the direction to scroll. The **direction** argument is the address of a longword bit mask that contains the direction code.

Valid values are SMG\$M\_UP, SMG\$M\_DOWN, SMG\$M\_RIGHT, and SMG\$M\_LEFT. SMG\$M\_UP is the default.

#### count

OpenVMS usage: longword\_signed  
type: longword (signed)  
access: read only  
mechanism: by reference

Specifies the number of lines or columns to scroll. The **count** argument is the address of a signed longword that contains the number of units (lines or columns) to scroll. If omitted, one unit is scrolled.

## Description

SMG\$SCROLL\_DISPLAY\_AREA scrolls a rectangular region of the specified virtual display. It scrolls the region a specified number of lines or columns in the specified direction. After the scroll, the cursor is left at the **start-row**, **start-column** position.

### Condition Values Returned

|                 |                                                       |
|-----------------|-------------------------------------------------------|
| SS\$_NORMAL     | Normal successful completion.                         |
| SMG\$_INVARG    | The defined rectangle is outside the virtual display. |
| SMG\$_INVCOL    | Invalid column.                                       |
| SMG\$_INVDIS_ID | Invalid <b>display-id</b> .                           |
| SMG\$_INVROW    | Invalid row.                                          |
| SMG\$_WRONUMARG | Wrong number of arguments.                            |

---

## SMG\$SCROLL\_VIEWPORT

### Scroll a Display Under a Viewport

The Scroll a Display Under a Viewport routine scrolls a virtual display under its associated viewport.

#### Format

SMG\$SCROLL\_VIEWPORT display-id [,direction] [,count]

#### Returns

OpenVMS usage: cond\_value  
type: longword (unsigned)  
access: write only  
mechanism: by value

#### Arguments

##### display-id

OpenVMS usage: identifier  
type: longword (unsigned)  
access: read only  
mechanism: by reference

Display identifier of the virtual display to be scrolled. The **display-id** argument is the address of an unsigned longword containing this identifier.

##### direction

OpenVMS usage: mask\_longword  
type: longword (unsigned)  
access: read only  
mechanism: by reference

Optional direction specifier. The **direction** argument is the address of a longword bit mask that contains the direction code specifying the scrolling direction. The optional **count** argument can be used to specify the number of lines to scroll in the specified direction. Valid values for **direction** are as follows:

|              |                                           |
|--------------|-------------------------------------------|
| SMG\$M_UP    | Scroll <b>count</b> lines upward.         |
| SMG\$M_DOWN  | Scroll <b>count</b> lines downward.       |
| SMG\$M_RIGHT | Scroll <b>count</b> columns to the right. |
| SMG\$M_LEFT  | Scroll <b>count</b> columns to the left.  |

SMG\$M\_UP is the default.

##### count

OpenVMS usage: longword\_signed  
type: longword (signed)  
access: read only  
mechanism: by reference

Optional number of rows or columns to be scrolled. The default is 1.



## Description

SMG\$SCROLL\_VIEWPORT scrolls a virtual display under its associated viewport. The viewport is actually changing its coordinates as it moves over the virtual display to simulate scrolling; however, it does not change its physical location on the screen. The size of the viewport could change if the viewport moves off the virtual display. To restore the size of the viewport, use SMG\$CHANGE\_VIEWPORT.

## Condition Values Returned

|                   |                                                                                                             |
|-------------------|-------------------------------------------------------------------------------------------------------------|
| SSS_NORMAL        | Normal successful completion.                                                                               |
| SMG\$_INVARG      | The value of <b>count</b> is less than zero.                                                                |
| SMG\$_INVDIS_ID   | Invalid <b>display-id</b> .                                                                                 |
| SMG\$_NO_WINASSOC | No viewport is associated with the specified virtual display.                                               |
| SMG\$_WINTRUNCFIT | Successful completion; however, the viewport associated with the virtual display has been truncated to fit. |
| SMG\$_WRONUMARG   | Wrong number of arguments.                                                                                  |

## Example

```

C This Fortran example demonstrates SMG$SCROLL_VIEWPORT.
C Include the SMG definitions. In particular, we want SMG$_M_BORDER.
 IMPLICIT INTEGER (A-Z)
 INCLUDE '($SMGDEF)'

C Create the Virtual Displays. Give them borders.
 ROWS = 10
 COLUMNS = 22
 STATUS = SMG$CREATE_VIRTUAL_DISPLAY
1 (ROWS, COLUMNS, DISPLAY1, SMG$_M_BORDER)
 IF (.NOT. STATUS) CALL LIB$SIGNAL(%VAL(STATUS))

C Create viewport
 STATUS = SMG$CREATE_VIEWPORT (DISPLAY1, 2, 2, 3, 10)
 IF (.NOT. STATUS) CALL LIB$SIGNAL(%VAL(STATUS))

C Create the Pasteboard
 STATUS = SMG$CREATE_PASTEBOARD (PASTE1)
 IF (.NOT. STATUS) CALL LIB$SIGNAL(%VAL(STATUS))

C Put data into the Virtual Displays
 STATUS = SMG$PUT_CHARS (DISPLAY1, '11111111111111', 1, 1)
 IF (.NOT. STATUS) CALL LIB$SIGNAL(%VAL(STATUS))
 STATUS = SMG$PUT_CHARS (DISPLAY1, 'This is row 2.', 2, 1)
 IF (.NOT. STATUS) CALL LIB$SIGNAL(%VAL(STATUS))
 STATUS = SMG$PUT_CHARS (DISPLAY1, '33333333333333', 3, 1)
 IF (.NOT. STATUS) CALL LIB$SIGNAL(%VAL(STATUS))
 STATUS = SMG$PUT_CHARS (DISPLAY1, 'This is row 4.', 4, 1)
 IF (.NOT. STATUS) CALL LIB$SIGNAL(%VAL(STATUS))

```

## SMG\$ Routines

### SMG\$SCROLL\_VIEWPORT

```
STATUS = SMG$PUT_CHARS (DISPLAY1, '55555555555555', 5, 1)
IF (.NOT. STATUS) CALL LIB$SIGNAL(%VAL(STATUS))
STATUS = SMG$PUT_CHARS (DISPLAY1, 'This is row 6.', 6, 1)
IF (.NOT. STATUS) CALL LIB$SIGNAL(%VAL(STATUS))
STATUS = SMG$PUT_CHARS (DISPLAY1, '77777777777777', 7, 1)
IF (.NOT. STATUS) CALL LIB$SIGNAL(%VAL(STATUS))
STATUS = SMG$PUT_CHARS (DISPLAY1, 'This is row 8.', 8, 1)
IF (.NOT. STATUS) CALL LIB$SIGNAL(%VAL(STATUS))
STATUS = SMG$PUT_CHARS (DISPLAY1, '99999999999999', 9, 1)
IF (.NOT. STATUS) CALL LIB$SIGNAL(%VAL(STATUS))
STATUS = SMG$PUT_CHARS (DISPLAY1, 'This is row 10.', 10, 1)
IF (.NOT. STATUS) CALL LIB$SIGNAL(%VAL(STATUS))
```

C Paste the Virtual Display

```
STATUS = SMG$PASTE_VIRTUAL_DISPLAY (DISPLAY1, PASTE1, 4, 3)
IF (.NOT. STATUS) CALL LIB$SIGNAL(%VAL(STATUS))

STATUS = LIB$WAIT (2.0)

DO 1 I = 1, 3
STATUS = SMG$SCROLL_VIEWPORT(DISPLAY1, SMG$M_UP, 1)
IF (.NOT. STATUS) CALL LIB$SIGNAL(%VAL(STATUS))
CALL LIB$WAIT (2.0)
1 CONTINUE

STATUS = LIB$WAIT (2.0)
```

END

**In this example, a single virtual display is created and is associated with a viewport. Since the virtual display is pasted to the pasteboard after it is associated with the viewport, only the portion of the virtual display that falls inside the viewport is visible. This is displayed in Figure SMG-45.**

Figure SMG-45 Output Generated by Pasting the Virtual Display

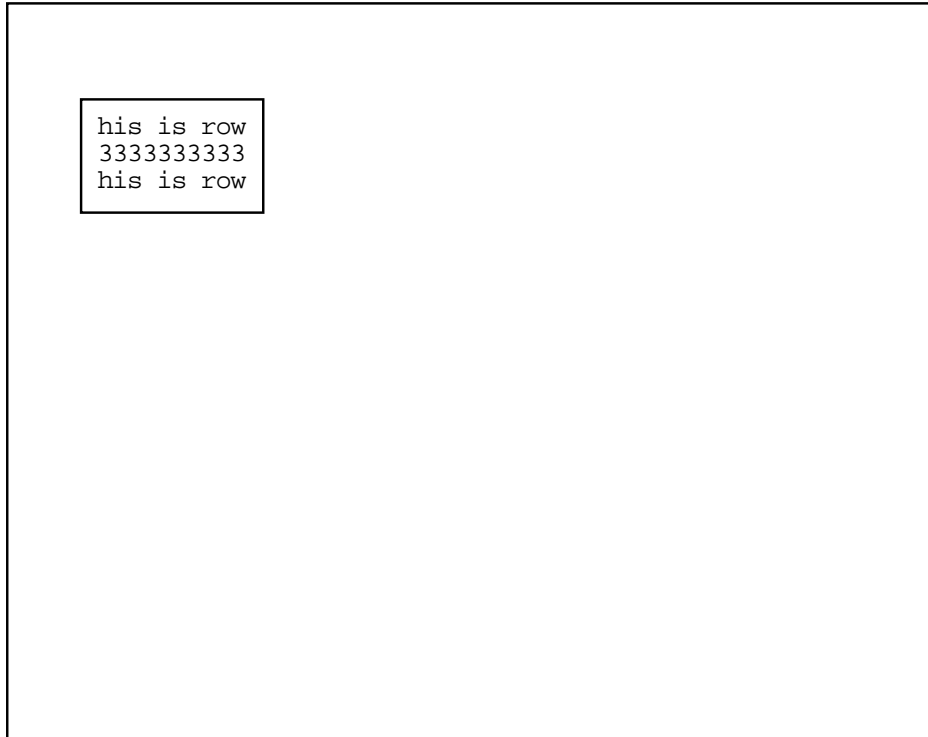

ZK-6426/1-GE

## SMG\$ Routines

### SMG\$SCROLL\_VIEWPORT

The call to SMG\$SCROLL\_VIEWPORT is repeated a total of three times. Figure SMG-46 shows the viewport after the first call to SMG\$SCROLL\_VIEWPORT.

**Figure SMG-46 Output Generated After First Call to SMG\$SCROLL\_VIEWPORT**

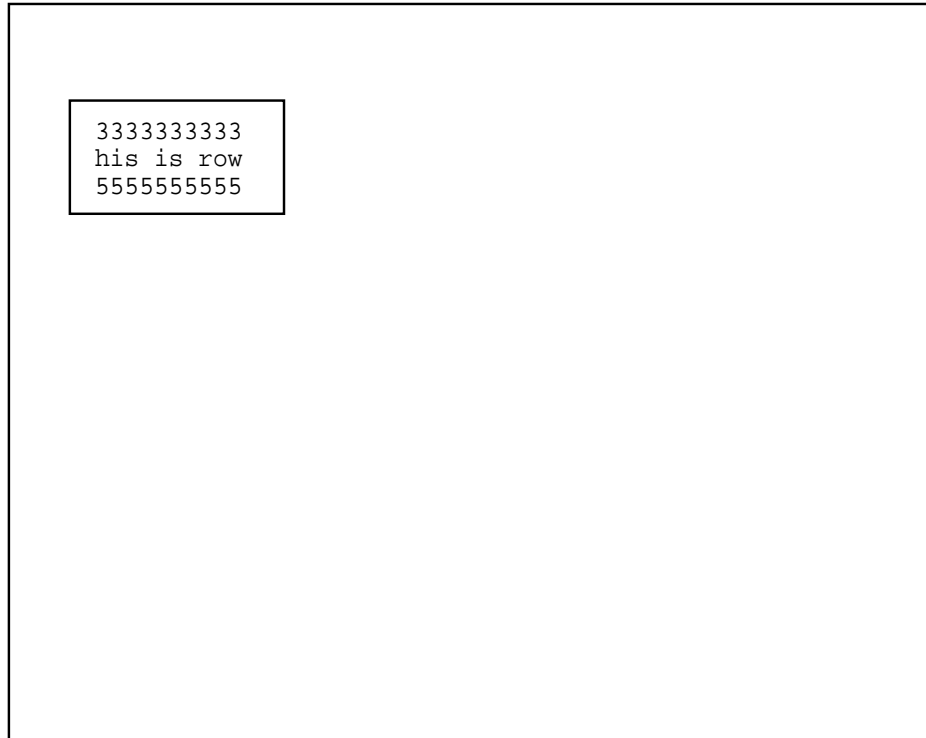

ZK-6426/2-GE

**SMG\$ Routines**  
**SMG\$SCROLL\_VIEWPORT**

Figure SMG-47 shows the contents of the viewport after the second call to SMG\$SCROLL\_VIEWPORT.

**Figure SMG-47 Output Generated After the Second Call to SMG\$SCROLL\_VIEWPORT**

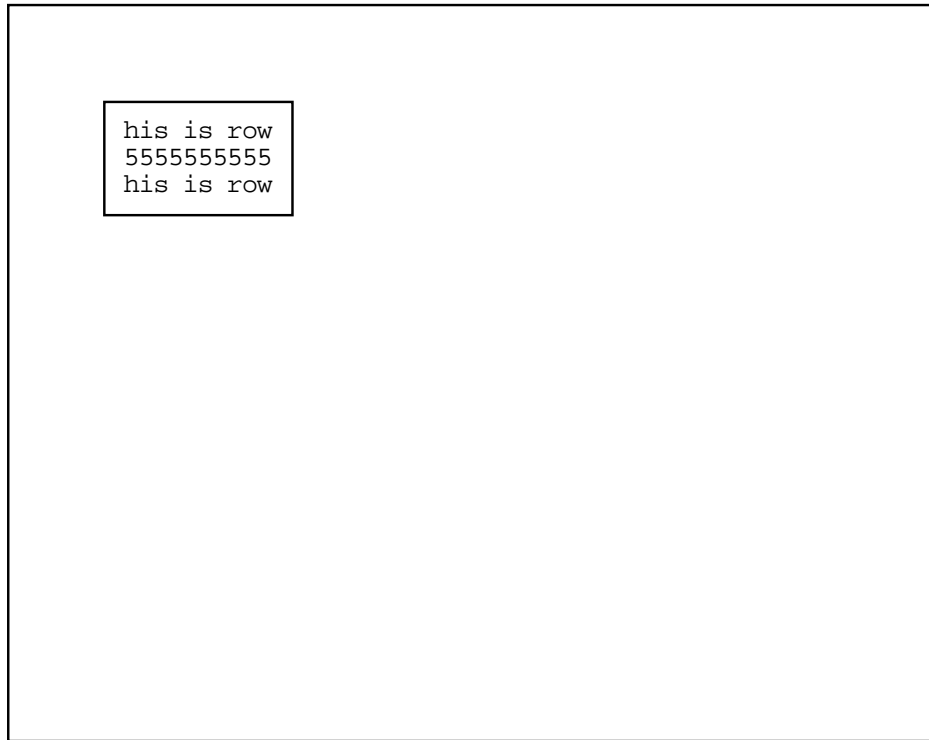

ZK-6426/3-GE

**SMG\$ Routines**  
**SMG\$SCROLL\_VIEWPORT**

Figure SMG-48 shows the contents of the viewport after the last call to SMG\$SCROLL\_VIEWPORT.

**Figure SMG-48 Output Generated After the Last Call to SMG\$SCROLL\_VIEWPORT**

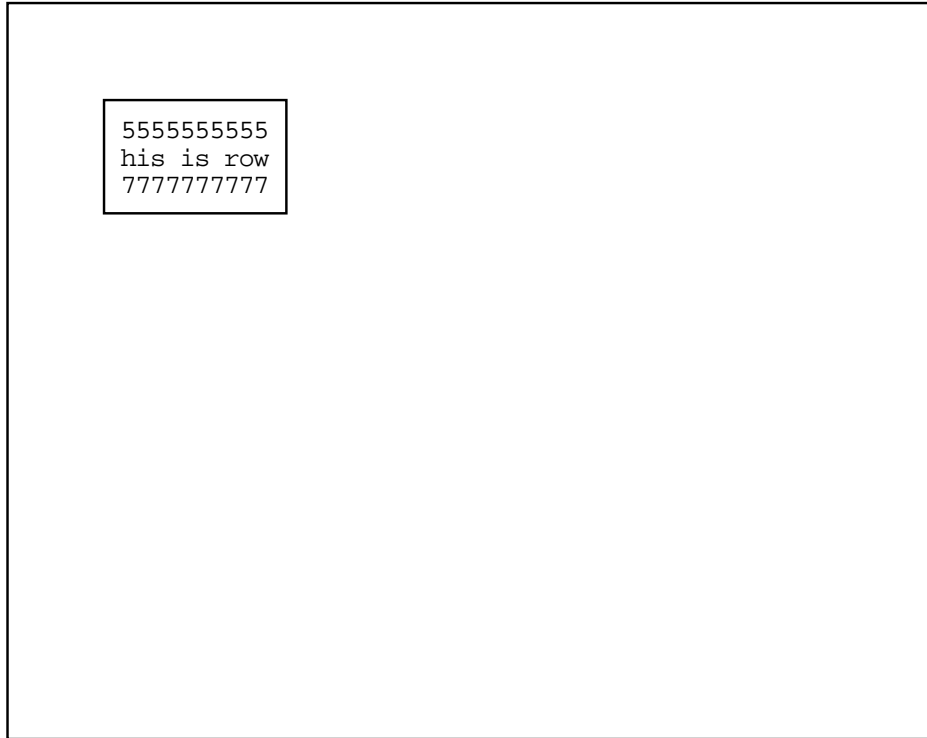

ZK-6426/4-GE

---

## SMG\$SELECT\_FROM\_MENU

### Make a Selection from the Menu

The Make a Selection from the Menu routine lets you move between the menu choices using the arrow keys and lets you make a selection by pressing the Return key.

#### Format

```
SMG$SELECT_FROM_MENU keyboard-id ,display-id ,selected-choice-number
 [,default-choice-number] [,flags] [,help-library]
 [,timeout] [,word-terminator-code]
 [,selected-choice-string] [,rendition-set]
 [,rendition-complement]
```

#### Returns

```
OpenVMS usage: cond_value
type: longword (unsigned)
access: write only
mechanism: by value
```

#### Arguments

##### keyboard-id

```
OpenVMS usage: identifier
type: longword (unsigned)
access: read only
mechanism: by reference
```

Identifier of the virtual keyboard from which the terminal user's responses are read. The **keyboard-id** argument is the address of an unsigned longword containing this identifier.

##### display-id

```
OpenVMS usage: identifier
type: longword (unsigned)
access: read only
mechanism: by reference
```

Identifier of the virtual display in which the choices are displayed. The **display-id** argument is the address of an unsigned longword containing this display identifier. This virtual display must be pasted to a pasteboard and cannot be batched or occluded.

##### selected-choice-number

```
OpenVMS usage: word_unsigned
type: word (unsigned)
access: write only
mechanism: by reference
```

Identification number of the menu item selected. The **selected-choice-number** argument is the address of an unsigned word that receives this number. The **selected-choice-number** corresponds to the index of the menu item in the static string array specified in SMG\$CREATE\_MENU.

## SMG\$ Routines

### SMG\$SELECT\_FROM\_MENU

#### default-choice-number

OpenVMS usage: word\_unsigned  
type: word (unsigned)  
access: read only  
mechanism: by reference

Optional identification number of the default menu item. The **default-choice-number** argument is the address of an unsigned word that contains the number of the default menu item. The **default-choice-number** corresponds to the index of the default menu item in the static string array specified in SMG\$CREATE\_MENU. If omitted, the default choice will be the last menu item already selected, or the first item in the menu if no selections have yet been made.

#### flags

OpenVMS usage: mask\_longword  
type: longword (unsigned)  
access: read only  
mechanism: by reference

Optional bit mask indicating behavior when a selection is made. The **flags** argument is the address of an unsigned longword containing the flag. Valid values are as follows:

SMG\$M\_RETURN\_IMMED Returns control to the user when any key other than an arrow key is entered.

SMG\$M\_REMOVE\_ITEM Causes SMG\$SELECT\_FROM\_MENU to allow each menu item to be selected only once.

#### help-library

OpenVMS usage: char\_string  
type: character string  
access: read only  
mechanism: by descriptor

Optional help library to use if the PF2/Help key is pressed. The **help-library** argument is the address of a descriptor pointing to this help library name. Note that this argument is ignored if **flags** specifies SMG\$M\_RETURN\_IMMED. The default is SYSSHELP:HELPLIB.HLB.

#### timeout

OpenVMS usage: longword\_signed  
type: longword (signed)  
access: read only  
mechanism: by reference

Optional timeout value. The **timeout** argument is the address of a signed longword that specifies the number of seconds to wait for a selection to be made.

#### word-terminator-code

OpenVMS usage: word\_unsigned  
type: word (unsigned)  
access: write only  
mechanism: by reference

Optional unsigned word that receives the code indicating which key terminated the read. The **word-terminator-code** argument is the address of an unsigned word that receives this terminating key code.



**selected-choice-string**

OpenVMS usage: char\_string  
type: character string  
access: write only  
mechanism: by descriptor

Optional string that receives the text of the menu item selected. The **selected-choice-string** is the address of a descriptor pointing to this string.

**rendition-set**

OpenVMS usage: mask\_longword  
type: longword (unsigned)  
access: read only  
mechanism: by reference

Attribute specifier. The optional **rendition-set** argument is the address of a longword bit mask in which each attribute set causes the corresponding attribute to be set in the display. The following attributes can be specified using the **rendition-set** argument:

|                                         |                                                                                                                    |
|-----------------------------------------|--------------------------------------------------------------------------------------------------------------------|
| SMG\$M_BLINK                            | Displays blinking characters.                                                                                      |
| SMG\$M_BOLD                             | Displays characters in higher-than-normal intensity.                                                               |
| SMG\$M_REVERSE                          | Displays characters in reverse video; that is, using the opposite of the default rendition of the virtual display. |
| SMG\$M_UNDERLINE                        | Displays underlined characters.                                                                                    |
| SMG\$M_USER1<br>through<br>SMG\$M_USER8 | Displays user-defined attributes.                                                                                  |

The **display-id** argument must be specified when you use the **rendition-set** argument.

**rendition-complement**

OpenVMS usage: mask\_longword  
type: longword (unsigned)  
access: read only  
mechanism: by reference

Attribute complement specifier. The optional **rendition-complement** argument is the address of a longword bit mask in which each attribute set causes the corresponding attribute to be complemented in the display. All attributes that can be specified with the **rendition-set** argument can be complemented with the **rendition-complement** argument. The **display-id** argument must be specified when you use the **rendition-complement** argument.

The optional arguments **rendition-set** and **rendition-complement** let the user control the attributes of the virtual display. The **rendition-set** argument sets certain virtual display attributes, while **rendition-complement** complements these attributes. If the same bit is specified in both the **rendition-set** and **rendition-complement** parameters, **rendition-set** is evaluated first, followed by **rendition-complement**. By using these two parameters together, the user can control each virtual display attribute in a single procedure call. On a single-attribute basis, the user can cause the following transformations:

## SMG\$ Routines

### SMG\$SELECT\_FROM\_MENU

| Set | Complement | Action                                         |
|-----|------------|------------------------------------------------|
| 0   | 0          | Attribute set to default                       |
| 1   | 0          | Attribute on                                   |
| 0   | 1          | Attribute set to complement of default setting |
| 1   | 1          | Attribute off                                  |

### Description

SMG\$SELECT\_FROM\_MENU lets you make a selection from the items in the menu. The routine SMG\$CREATE\_MENU must be called before calling SMG\$SELECT\_FROM\_MENU.

You can move between the various menu items using the arrow keys, and make a selection by pressing the Return key. Pressing Ctrl/Z selects the current choice and returns the value SMG\$\_EOF. If there are more menu choices than can be displayed, you can scroll the display by pressing the appropriate arrow key, which makes visible additional menu choices.

The current selection is indicated in reverse video (or in the rendition specified) and by the physical cursor. The selected choice is returned to the caller in the **selected-choice-number** argument. In addition, the selected item will be removed from the remaining menu items if SMG\$M\_REMOVE\_ITEM is specified for the **flags** parameter.

SMG\$SELECT\_FROM\_MENU has two modes of operation that are specified using the **flags** argument. A value without SMG\$M\_RETURN\_IMMED (the default) causes the following behavior:

- The user can move among the choices using the arrow keys.
- The only keys that select the current item are the following:
  - Return
  - Do
  - Select
  - Enter
- HELP or PF2 outputs help for the current item.
- Ctrl/W refreshes the screen by calling SMG\$REPAINT\_SCREEN.
- Ctrl/Z selects the current item and returns a value of SMG\$\_EOF.
- PF1 up arrow selects the first item in the menu.
- PF1 down arrow selects the last item in the menu.
- PF1 left arrow selects the first item in the current row.
- PF1 right arrow selects the last item in the current row.
- All other keys are ignored.

A value of SMG\$M\_RETURN\_IMMED enables the following:

- The user can move among the menu choices using the arrow keys.
- Ctrl/Z selects the current item and returns SMG\$\_EOF.
- Any other key entered selects the current item.

The SMG\$K\_TRM\_*keyname* code for the terminating key is returned in the optional **word-terminator-code** argument. Multiword menu items are allowed.

### Condition Values Returned

|                  |                                                                                                                                                                                                                                        |
|------------------|----------------------------------------------------------------------------------------------------------------------------------------------------------------------------------------------------------------------------------------|
| SS\$ _NORMAL     | Normal successful completion.                                                                                                                                                                                                          |
| SMG\$ _EOF       | End of file.                                                                                                                                                                                                                           |
| SMG\$ _ILLBATFNC | The virtual display or pasteboard is batched.                                                                                                                                                                                          |
| SMG\$ _INVARG    | Invalid argument or none of the menu items is selectable.                                                                                                                                                                              |
| SMG\$ _INVDIS_ID | The <b>display-id</b> is invalid, does not contain a menu, or contains a viewport.                                                                                                                                                     |
| SMG\$ _NOTPASTED | The virtual display is not pasted.                                                                                                                                                                                                     |
| SMG\$ _xxxx      | Any completion status returned by SMG\$CHANGE_RENDITION, SMG\$SET_CURSOR_ABS, SMG\$BEGIN_DISPLAY_UPDATE, SMG\$END_DISPLAY_UPDATE, SMG\$READ_KEYSTROKE, SMG\$PUT_HELP_TEXT, SMG\$SAVE_PHYSICAL_SCREEN, or SMG\$RESTORE_PHYSICAL_SCREEN. |
| LIB\$ _xxxx      | Any completion status returned by LIB\$SCOPY.                                                                                                                                                                                          |

### Examples

```

1. ! +
! This VAX Pascal program demonstrates the use of SMG$CREATE_MENU and
! SMG$SELECT_FROM_MENU. This program creates a block menu
! and allows the user to make selections from the menu.
! -

[INHERIT ('SYS$LIBRARY:STARLET')]
PROGRAM BLOCK_MENU (INPUT,OUTPUT);

CONST
 NULL = 0;

TYPE
 CHAR_STRING = VARYING [20] OF CHAR;
 WORD = [WORD] 0..65535;
 FIXED_STRING = PACKED ARRAY[1..9] OF CHAR;

VAR
 OPTIONS : ARRAY[1..9] OF FIXED_STRING;
 I : INTEGER;
 RET_STATUS : UNSIGNED;
 SELECTED : FIXED_STRING;
 NUMBER, DEF_NUMBER : WORD;
 PB_ID, KB_ID, DISPLAY1, DISPLAY2 : UNSIGNED;
 TERM : WORD;

[EXTERNAL] FUNCTION SMG$CREATE_PASTEBOARD(
 VAR PASTEBOARD_ID : UNSIGNED
) : INTEGER; EXTERN;

[EXTERNAL] FUNCTION SMG$CREATE_VIRTUAL_KEYBOARD(
 VAR KEYBOARD_ID : UNSIGNED
) : INTEGER; EXTERN;

```

## SMG\$ Routines

### SMG\$SELECT\_FROM\_MENU

```
[EXTERNAL] FUNCTION SMG$CREATE_VIRTUAL_DISPLAY(
 NUM_ROWS : INTEGER;
 NUM_COLS : INTEGER;
 VAR DISPLAY_ID : UNSIGNED;
 ATTRIBUTES : UNSIGNED
) : INTEGER; EXTERN;

[EXTERNAL] FUNCTION SMG$PASTE_VIRTUAL_DISPLAY(
 DISPLAY_ID : UNSIGNED;
 PASTEBOARD_ID : UNSIGNED;
 ROW : INTEGER;
 COL : INTEGER
) : INTEGER; EXTERN;

[EXTERNAL] FUNCTION SMG$CREATE_MENU(
 DISPLAY_ID : UNSIGNED;
 CHOICES : ARRAY[A..B : INTEGER] OF FIXED_STRING;
 MENU_TYPE : UNSIGNED;
 MENU_FLAGS : UNSIGNED;
 ROW : INTEGER := %IMMED 0;
 REND_SET : UNSIGNED := %IMMED 0;
 REND_COMP : UNSIGNED
) : INTEGER; EXTERN;

[EXTERNAL] FUNCTION SMG$SELECT_FROM_MENU(
 KEYBOARD_ID : UNSIGNED;
 DISPLAY_ID : UNSIGNED;
 VAR SELEC_NUM : WORD;
 DEFAULT_NUM : WORD;
 MENU_FLAGS : UNSIGNED;
 HELP_LIBR : CHAR_STRING := %IMMED 0;
 TIMEOUT : INTEGER := %IMMED 0;
 VAR TERM_CODE : WORD;
 VAR SELEC_STR : FIXED_STRING
) : INTEGER; EXTERN;

[EXTERNAL] FUNCTION SMG$PUT_LINE(
 DISPLAY_ID : UNSIGNED;
 TEXT : CHAR_STRING
) : INTEGER; EXTERN;

[EXTERNAL] FUNCTION SMG$DELETE_MENU(
 DISPLAY_ID : UNSIGNED
) : INTEGER; EXTERN;

[EXTERNAL] FUNCTION LIB$STOP(
 CONDITION_STATUS : [IMMEDIATE,UNSAFE] UNSIGNED
) : INTEGER; EXTERN;

BEGIN
 DEF_NUMBER := 5;
 OPTIONS[1] := 'Northwest';
 OPTIONS[2] := 'North ';
 OPTIONS[3] := 'Northeast';
 OPTIONS[4] := 'West ';
 OPTIONS[5] := 'Equator ';
 OPTIONS[6] := 'East ';
 OPTIONS[7] := 'Southwest';
 OPTIONS[8] := 'South ';
 OPTIONS[9] := 'Southeast';

 RET_STATUS := SMG$CREATE_PASTEBOARD (PB_ID);
 IF NOT ODD(RET_STATUS)
 THEN
 LIB$STOP(RET_STATUS);
```

## SMG\$ Routines SMG\$SELECT\_FROM\_MENU

```
RET_STATUS := SMG$CREATE_VIRTUAL_KEYBOARD (KB_ID);
IF NOT ODD(RET_STATUS)
THEN
 LIB$STOP(RET_STATUS);

RET_STATUS := SMG$CREATE_VIRTUAL_DISPLAY (3, 12, DISPLAY2, SMG$M_BORDER);
IF NOT ODD(RET_STATUS)
THEN
 LIB$STOP(RET_STATUS);

RET_STATUS := SMG$CREATE_VIRTUAL_DISPLAY (6, 37, DISPLAY1, SMG$M_BORDER);
IF NOT ODD(RET_STATUS)
THEN
 LIB$STOP(RET_STATUS);

RET_STATUS := SMG$PASTE_VIRTUAL_DISPLAY (DISPLAY2, PB_ID, 2, 16);
IF NOT ODD(RET_STATUS)
THEN
 LIB$STOP(RET_STATUS);

RET_STATUS := SMG$PASTE_VIRTUAL_DISPLAY (DISPLAY1, PB_ID, 10, 10);
IF NOT ODD(RET_STATUS)
THEN
 LIB$STOP(RET_STATUS);

RET_STATUS := SMG$CREATE_MENU (DISPLAY1, OPTIONS, SMG$K_BLOCK,
 SMG$M_DOUBLE_SPACE,,, SMG$M_BOLD);
IF NOT ODD(RET_STATUS)
THEN
 LIB$STOP(RET_STATUS);

RET_STATUS := SMG$SELECT_FROM_MENU (KB_ID, DISPLAY1, NUMBER, DEF_NUMBER,
 SMG$M_RETURN_IMMED,,, TERM, %DESCR SELECTED);
IF NOT ODD(RET_STATUS)
THEN
 LIB$STOP(RET_STATUS);

RET_STATUS := SMG$PUT_LINE (DISPLAY2, %DESCR SELECTED);
IF NOT ODD(RET_STATUS)
THEN
 LIB$STOP(RET_STATUS);

END.
```

The output for this VAX Pascal program is shown in the following figures. In Figure SMG-49, the program is waiting for the user to make a menu selection.

**SMG\$ Routines**  
**SMG\$SELECT\_FROM\_MENU**

**Figure SMG-49 Output Generated Before a Menu Selection Is Made**

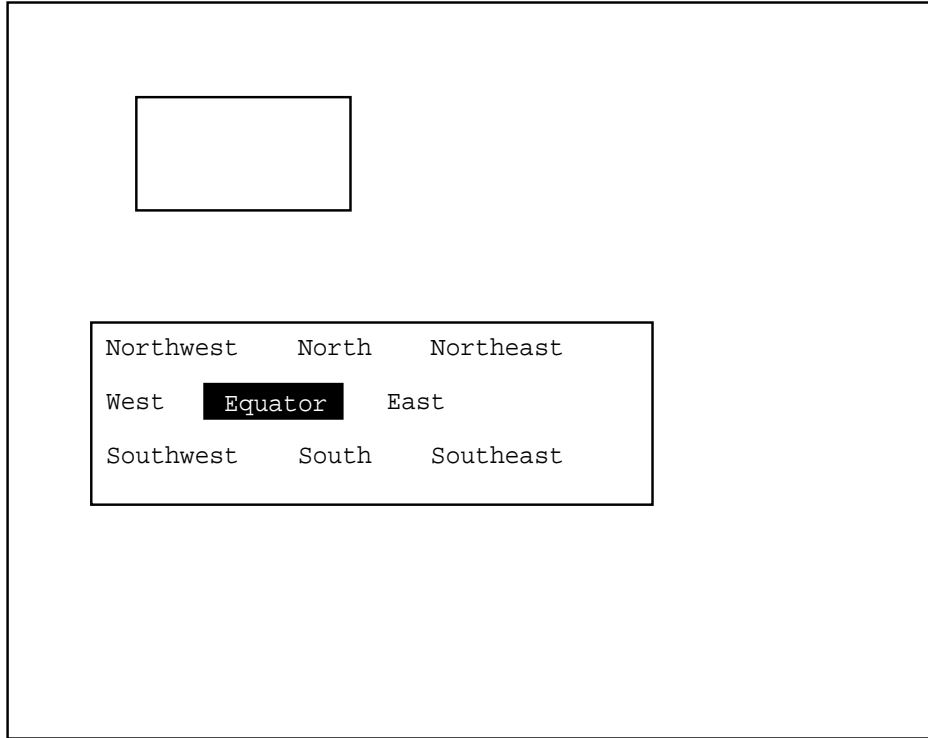

ZK-6427/1-GE

Because the menu is created using the SMG\$M\_RETURN\_IMMED attribute, once the user makes a selection the menu is terminated, and control returns to the program. The menu item selected by the user is displayed in the upper virtual display. This output is shown in Figure SMG-50.

**Figure SMG-50 Output Generated After the User Selects an Item**

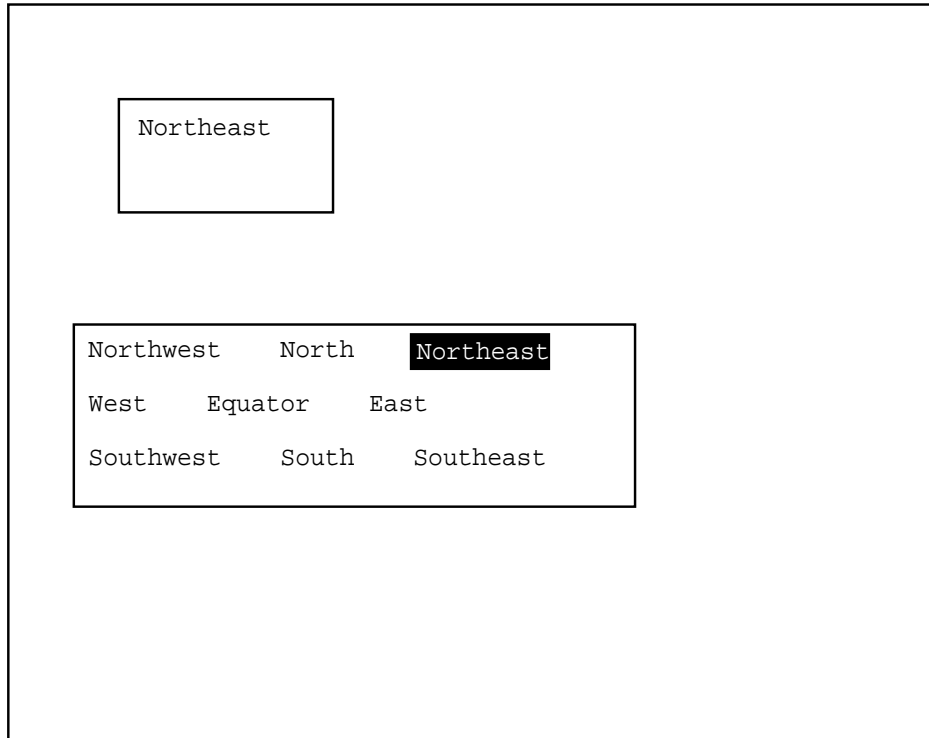

ZK-6427/2-GE

```

2. 10 !+
 !This VAX BASIC program demonstrates the use of
 !SMG-supported menus. Using SMG$CREATE_MENU and
 !SMG$SELECT_FROM_MENU, this program creates an
 !application that uses a vertical menu and allows
 !the user to make multiple selections.
 !-

 OPTION TYPE = EXPLICIT

 EXTERNAL SUB LIB$STOP (LONG BY VALUE)
 EXTERNAL LONG FUNCTION SMG$CREATE_PASTEBOARD (LONG)
 EXTERNAL LONG FUNCTION SMG$CREATE_VIRTUAL_KEYBOARD (LONG)
 EXTERNAL LONG FUNCTION SMG$CREATE_VIRTUAL_DISPLAY (LONG, LONG, &
 LONG, LONG, LONG)
 EXTERNAL LONG FUNCTION SMG$PASTE_VIRTUAL_DISPLAY (LONG, LONG, &
 LONG, LONG)
 EXTERNAL LONG FUNCTION SMG$CREATE_MENU (LONG, STRING DIM(), LONG, &
 LONG, LONG, LONG, LONG)
 EXTERNAL LONG FUNCTION SMG$SELECT_FROM_MENU (LONG, LONG, WORD, &
 WORD, LONG, STRING, LONG, WORD, STRING)
 EXTERNAL LONG FUNCTION SMG$PUT_LINE (LONG, STRING)
 EXTERNAL LONG FUNCTION SMG$DELETE_MENU (LONG)

 %INCLUDE "$SMGDEF" %FROM %LIBRARY "SYS$LIBRARY: BASIC$STARLET"

 DECLARE STRING chosen
 MAP (xyz) STRING choice(20) = 16
 DECLARE LONG ret_status, pasteboard_id, display1_id, display2_id, &
 keyboard_id
 DECLARE WORD number

```

## SMG\$ Routines

### SMG\$SELECT\_FROM\_MENU

```
choice(0) = "ONE"
choice(1) = "TWO"
choice(2) = "THREE"
choice(3) = "FOUR"
choice(4) = "FIVE"
choice(5) = "SIX"
choice(6) = "SEVEN"
choice(7) = "EIGHT"
choice(8) = "NINE"
choice(9) = "TEN"
choice(10) = "ELEVEN"
choice(11) = "TWELVE"
choice(12) = "THIRTEEN"
choice(13) = "FOURTEEN"
choice(14) = "FIFTEEN"
choice(15) = "SIXTEEN"
choice(16) = "SEVENTEEN"
choice(17) = "EIGHTEEN"
choice(18) = "NINETEEN"
choice(19) = "TWENTY"
choice(20) = "Exit"

ret_status = SMG$CREATE_PASTEBOARD (pasteboard_id)
IF (ret_status AND 1%) = 0% THEN
 CALL LIB$STOP (ret_status BY VALUE)
END IF

ret_status = SMG$CREATE_VIRTUAL_KEYBOARD (keyboard_id)
IF (ret_status AND 1%) = 0% THEN
 CALL LIB$STOP (ret_status BY VALUE)
END IF

ret_status = SMG$CREATE_VIRTUAL_DISPLAY (10, 20, display1_id, &
 SMGM_BORDER, SMGM_BOLD)
IF (ret_status AND 1%) = 0% THEN
 CALL LIB$STOP (ret_status BY VALUE)
END IF

ret_status = SMG$CREATE_VIRTUAL_DISPLAY (6, 20, display2_id, &
 SMG$M_BORDER,)
IF (ret_status AND 1%) = 0% THEN
 CALL LIB$STOP (ret_status BY VALUE)
END IF

ret_status = SMG$PASTE_VIRTUAL_DISPLAY (display2_id, &
 pasteboard_id, 17, 20)
IF (ret_status AND 1%) = 0% THEN
 CALL LIB$STOP (ret_status BY VALUE)
END IF

ret_status = SMG$PASTE_VIRTUAL_DISPLAY (display1_id, &
 pasteboard_id, 4, 20)
IF (ret_status AND 1%) = 0% THEN
 CALL LIB$STOP (ret_status BY VALUE)
END IF

ret_status = SMG$CREATE_MENU (display1_id, choice(), &
 SMG$K_VERTICAL,, SMG$M_BOLD, SMG$M_BOLD)
IF (ret_status AND 1%) = 0% THEN
 CALL LIB$STOP (ret_status BY VALUE)
END IF

20 ret_status = SMG$SELECT_FROM_MENU (keyboard_id, display1_id, &
 number,, SMG$M_REMOVE_ITEM,,,chosen)
IF (ret_status AND 1%) = 0% THEN
 CALL LIB$STOP (ret_status BY VALUE)
END IF
```



## SMG\$ Routines SMG\$SELECT\_FROM\_MENU

```
ret_status = SMG$PUT_LINE (display2_id, chosen)
IF (ret_status AND 1%) = 0% THEN
 CALL LIB$STOP (ret_status BY VALUE)
END IF

IF (number <> 20) THEN
 GOTO 20
END IF

ret_status = SMG$DELETE_MENU (display1_id)
IF (ret_status AND 1%) = 0% THEN
 CALL LIB$STOP (ret_status BY VALUE)
END IF

END
```

The vertical menu generated by this VAX BASIC program is shown in the following figures. The default choice is set to the first item in the menu: "ONE". In Figure SMG-51, the program is waiting for the user to make a selection from the menu.

**Figure SMG-51 Output Generated Before the User Selects a Menu Item**

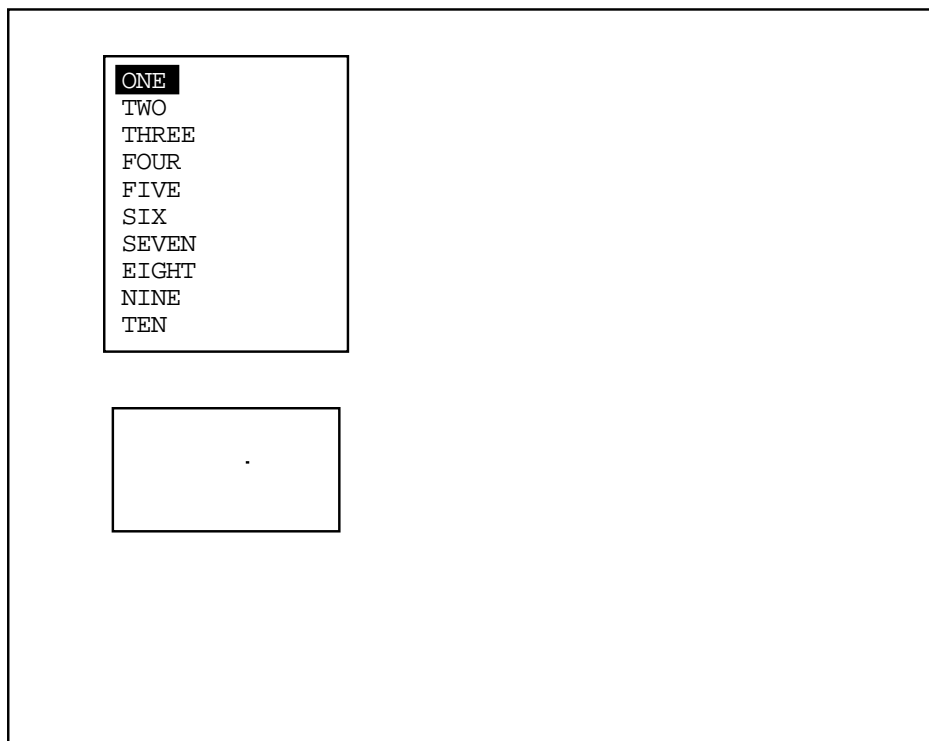

ZK-6428/1-GE

Because the menu was created with the SMG\$M\_REMOVE\_ITEM attribute, the user cannot reselect a particular menu item. However, unlike Example 1, the user can make multiple selections. In Figure SMG-52, the user has selected "SIX" and "THIRTEEN", and the program has again highlighted the default menu item and is waiting for the user to make another selection.

**SMG\$ Routines**  
**SMG\$SELECT\_FROM\_MENU**

**Figure SMG-52 Output Generated After Two Selections**

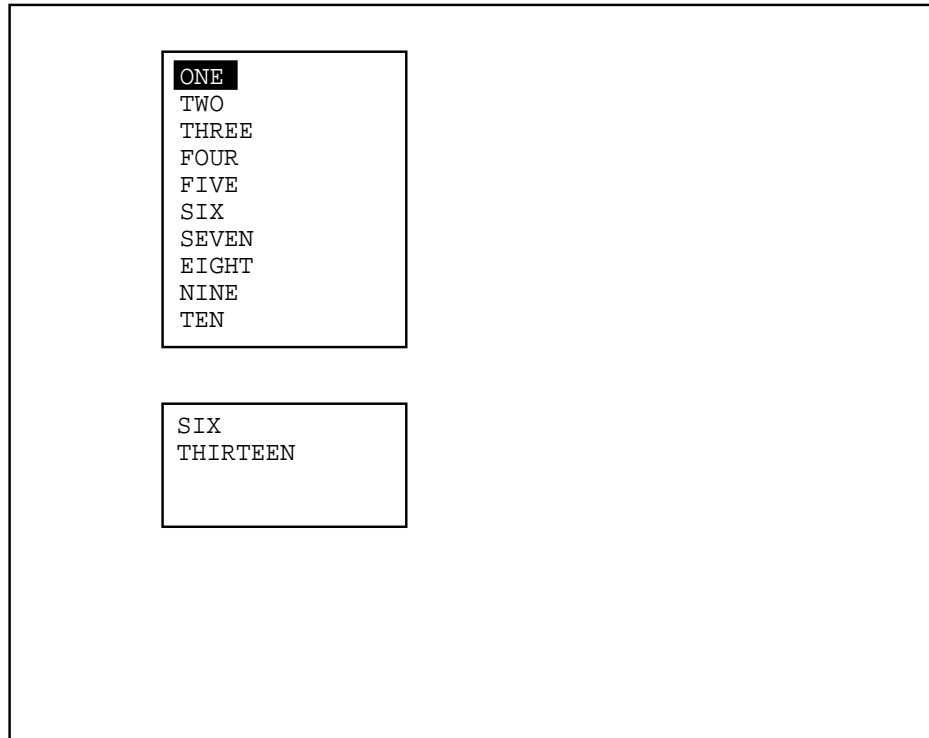

ZK-6428/2-GE

In Figure SMG-53, the user has selected "EXIT" and the menu has been deleted, although it still appears on the screen. At this point, no more selections can be made.

**Figure SMG-53 Output Generated After EXIT Is Selected**

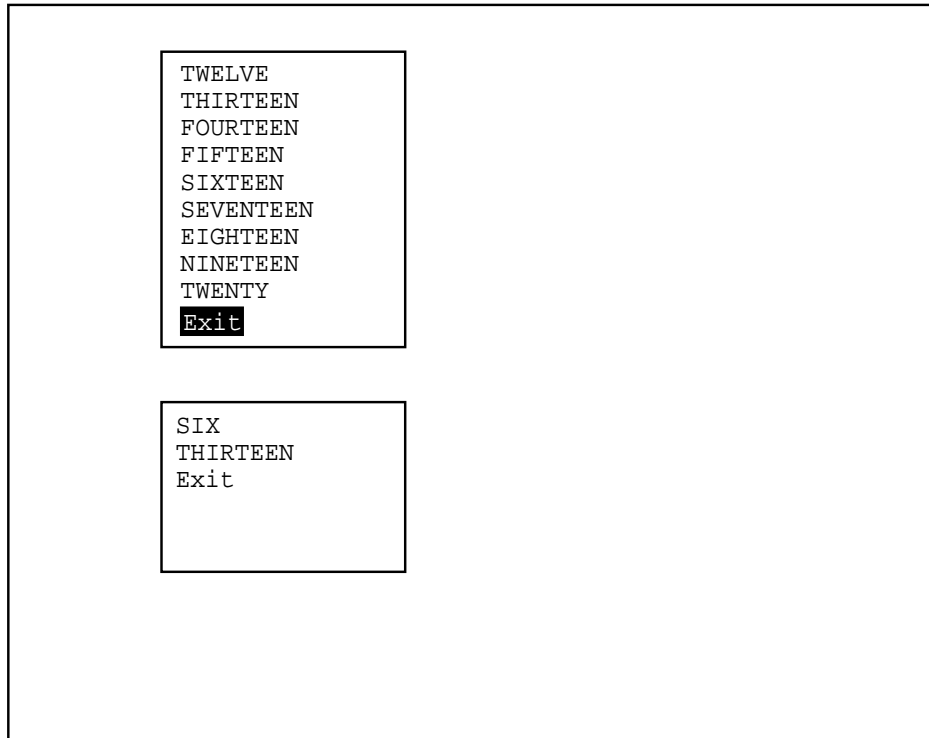

ZK-6428/3-GE

3. C+  
 C This Fortran example program shows the use of  
 C SMG\$CREATE\_MENU, SMG\$SELECT\_FROM\_MENU, and SMG\$DELETE\_MENU  
 C to create an application that lets a user make multiple  
 C selections from a horizontal menu.  
 C-

```

IMPLICIT INTEGER (A-Z)
INCLUDE '($SMGDEF)'

CHARACTER*20 c
CHARACTER*20 a(20) /'One','Two','Three','This is Four','Five',
1 'Six','Seven','Eight','Nine','I like ten',
2 'Eleven','Twelve','Thirteen','Fourteen',
3 'Fifteen','Sixteen','Seventeen','Eighteen',
4 'Nineteen','Exit this menu.' /

s = SMG$CREATE_PASTEBOARD(p_id)
if (.not. s) call LIB$SIGNAL(%VAL(s))
s = SMG$CREATE_VIRTUAL_KEYBOARD(k_id)
if (.not. s) call LIB$SIGNAL(%VAL(s))
s = SMG$CREATE_VIRTUAL_DISPLAY(6,50, d_id2, SMG$M_BORDER)
if (.not. s) call LIB$SIGNAL(%VAL(s))
s = SMG$CREATE_VIRTUAL_DISPLAY(6,50, d_id, SMG$M_BORDER)
if (.not. s) call LIB$SIGNAL(%VAL(s))

s = SMG$PASTE_VIRTUAL_DISPLAY(d_id2, p_id, 2,2)
if (.not. s) call LIB$SIGNAL(%VAL(s))
s = SMG$PASTE_VIRTUAL_DISPLAY(d_id, p_id, 10,2)
if (.not. s) call LIB$SIGNAL(%VAL(s))

```



Figure SMG-55 Output Generated After Three Menu Selections

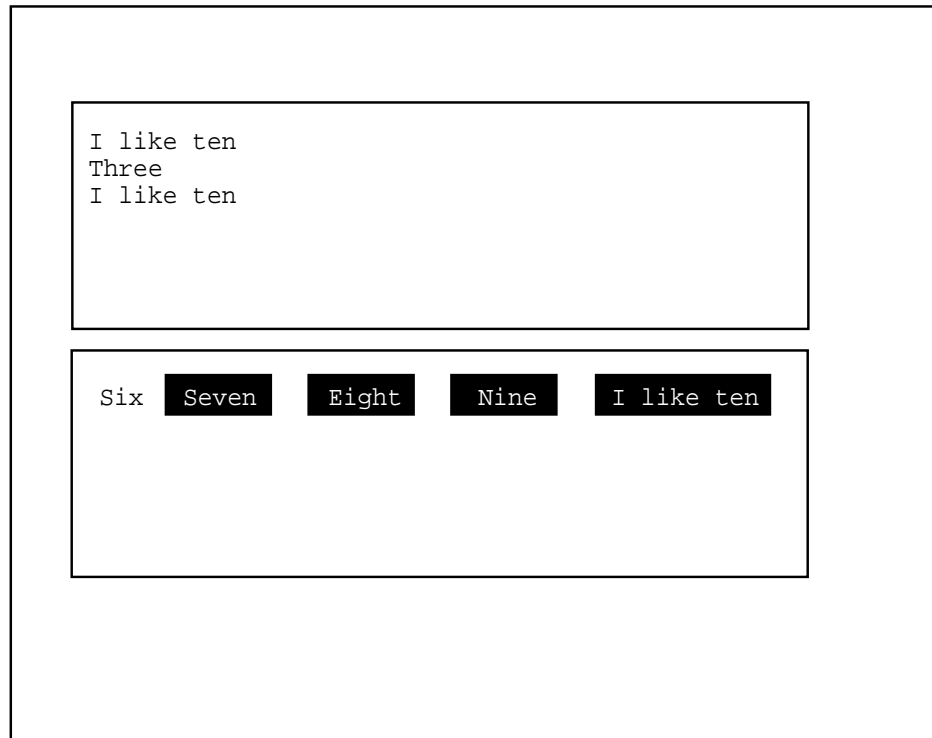

ZK-6429/2-GE

In Figure SMG-56, the user has selected “Exit this menu” and the program has completed execution.

**SMG\$ Routines**  
**SMG\$SELECT\_FROM\_MENU**

**Figure SMG-56 Output Generated After Program Completion**

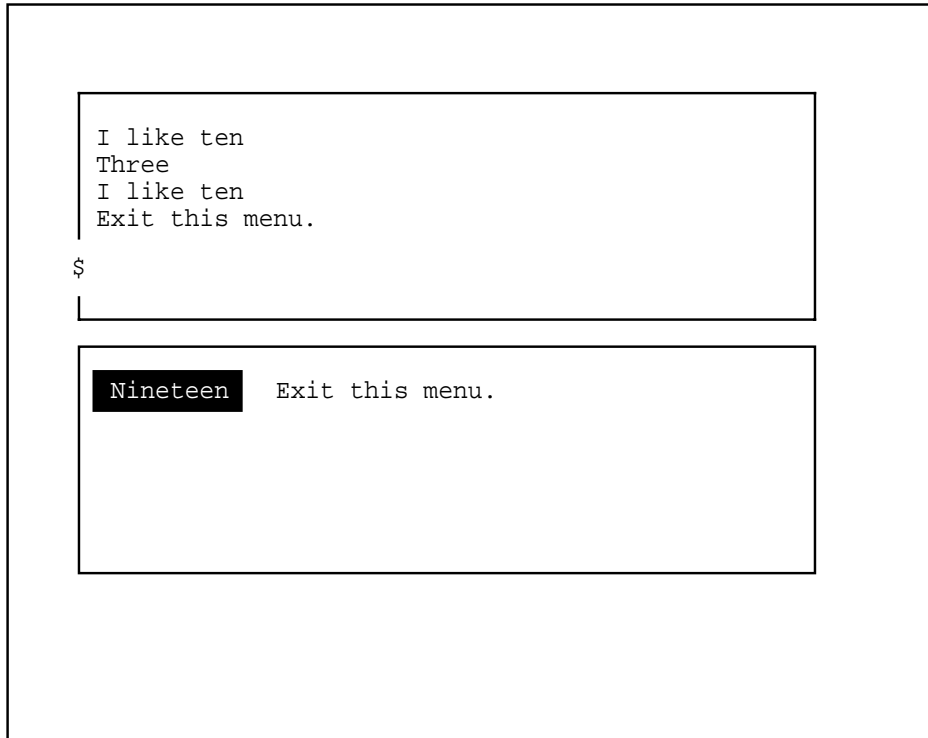

ZK-6429/3-GE

## SMG\$SET\_BROADCAST\_TRAPPING

### Enable Broadcast Trapping

The Enable Broadcast Trapping routine enables the trapping of broadcast messages.

#### Format

SMG\$SET\_BROADCAST\_TRAPPING pasteboard-id [,AST-routine] [,AST-argument]

#### Returns

OpenVMS usage: cond\_value  
type: longword (unsigned)  
access: write only  
mechanism: by value

#### Arguments

##### pasteboard-id

OpenVMS usage: identifier  
type: longword (unsigned)  
access: read only  
mechanism: by reference

Specifies the pasteboard for which broadcast messages are to be trapped. The **pasteboard-id** argument is the address of an unsigned longword that contains the pasteboard identifier.

The pasteboard identifier is returned by SMG\$CREATE\_PASTEBOARD.

##### AST-routine

OpenVMS usage: ast\_procedure  
type: procedure value  
access: read only  
mechanism: by value

The address of an AST routine to be called when a message is received at the pasteboard. The **AST-routine** argument is the address of the routine's procedure value.

When the **AST-routine** argument is either omitted or is given a value of 0, the BROADCAST mode is set to synchronize. In this mode, you must periodically call SMG\$GET\_BROADCAST\_MESSAGE to see if any broadcast messages have arrived.

The AST routine is called with five parameters: **AST-argument**, R0, R1, PC, and PSL (on VAX systems) or PS (on Alpha systems).

## SMG\$ Routines

### SMG\$SET\_BROADCAST\_TRAPPING

|              |
|--------------|
| AST Argument |
| R0           |
| R1           |
| PC           |
| PSL/PS       |

ZK-4803-GE

#### AST-argument

OpenVMS usage: user\_arg  
type: longword (unsigned)  
access: read only  
mechanism: by value

A value to be passed to the AST routine. The **AST-argument** is an unsigned longword that contains the value to be passed to the AST routine.

#### Description

SMG\$SET\_BROADCAST\_TRAPPING enables the trapping of broadcast messages sent to the specified pasteboard (terminal). When you disable broadcast trapping, any broadcast messages that have been queued to the terminal are lost. If you enable broadcast trapping with SMG\$SET\_BROADCAST\_TRAPPING but do not disable it with SMG\$DISABLE\_BROADCAST\_TRAPPING before the image exits, any messages that have been broadcast to the terminal are lost when the image exits.

The system parameters DEFMBXBUFQUO and DEFMBXMXMSG are used when creating the mailbox that receives broadcast messages.

#### Condition Values Returned

|                |                                                          |
|----------------|----------------------------------------------------------|
| SS\$NORMAL     | Normal successful completion.                            |
| SMG\$INVPAS_ID | Invalid <b>pasteboard-id</b> .                           |
| SMG\$NOT_A_TRM | Informational message; the pasteboard is not a terminal. |
| SMG\$WRONUMARG | Wrong number of arguments.                               |

Any condition values returned by \$DASSGN, \$CANCEL, or LIB\$ASN\_WTH\_MBX.

#### Example

For an example using SMG\$SET\_BROADCAST\_TRAPPING, see the example for SMG\$DISABLE\_BROADCAST\_TRAPPING.



---

## SMG\$SET\_CURSOR\_ABS

### Set Absolute Cursor Position

The Set Absolute Cursor Position routine moves the virtual cursor to the specified position in a virtual display.

#### Format

SMG\$SET\_CURSOR\_ABS display-id [,start-row] [,start-column]

#### Returns

OpenVMS usage: cond\_value  
type: longword (unsigned)  
access: write only  
mechanism: by value

#### Arguments

##### display-id

OpenVMS usage: identifier  
type: longword (unsigned)  
access: read only  
mechanism: by reference

Specifies the virtual display in which to set the virtual cursor position. The **display-id** argument is the address of an unsigned longword that contains the display identifier.

The display identifier is returned by SMG\$CREATE\_VIRTUAL\_DISPLAY.

##### start-row

OpenVMS usage: longword\_signed  
type: longword (signed)  
access: read only  
mechanism: by reference

Specifies the row position to which the virtual cursor moves. The **start-row** argument is the address of a signed longword that contains the row number. If omitted, the cursor remains at the current row.

##### start-column

OpenVMS usage: longword\_signed  
type: longword (signed)  
access: read only  
mechanism: by reference

Specifies the column position to which the virtual cursor moves. The **start-column** argument is the address of a signed longword that contains the column number. If omitted, the virtual cursor remains at the current column.

## SMG\$ Routines

### SMG\$SET\_CURSOR\_ABS

#### Description

SMG\$SET\_CURSOR\_ABS moves the virtual cursor to the specified position in the specified virtual display.

#### Condition Values Returned

|                 |                               |
|-----------------|-------------------------------|
| SS\$_NORMAL     | Normal successful completion. |
| SMG\$_INVCOL    | Invalid column.               |
| SMG\$_INVDIS_ID | Invalid <b>display-id</b> .   |
| SMG\$_INVROW    | Invalid row.                  |
| SMG\$_WRONUMARG | Wrong number of arguments.    |

---

## SMG\$SET\_CURSOR\_MODE

### Set the Cursor Mode

The Set the Cursor Mode routine turns the physical cursor on or off and selects jump or smooth scrolling.

#### Format

SMG\$SET\_CURSOR\_MODE pasteboard-id ,flags

#### Returns

OpenVMS usage: cond\_value  
type: longword (unsigned)  
access: write only  
mechanism: by value

#### Arguments

##### pasteboard-id

OpenVMS usage: identifier  
type: longword (unsigned)  
access: read only  
mechanism: by reference

Pasteboard identifier. The **pasteboard-id** argument is the address of an unsigned longword that contains the pasteboard identifier.

##### flags

OpenVMS usage: mask\_longword  
type: longword (unsigned)  
access: read only  
mechanism: by reference

Optional bit mask that specifies scrolling and cursor attributes. The **flags** argument is the address of an unsigned longword that contains the flag. The **flags** argument accepts the following values:

|                      |                           |
|----------------------|---------------------------|
| SMG\$M_CURSOR_OFF    | Clears physical cursor.   |
| SMG\$M_CURSOR_ON     | Displays physical cursor. |
| SMG\$M_SCROLL_JUMP   | Jump scrolls.             |
| SMG\$M_SCROLL_SMOOTH | Smooth scrolls.           |

#### Description

SMG\$SET\_CURSOR\_MODE turns the cursor on or off and selects jump or smooth scrolling. If your terminal does not have these capabilities defined, this routine has no effect.

**SMG\$ Routines**  
**SMG\$SET\_CURSOR\_MODE**

**Condition Values Returned**

|                 |                                |
|-----------------|--------------------------------|
| SS\$_NORMAL     | Normal successful completion.  |
| SMG\$_INVARG    | Invalid argument.              |
| SMG\$_INVPAS_ID | Invalid <b>pasteboard-id</b> . |
| SMG\$_WRONUMARG | Wrong number of arguments.     |

---

## SMG\$SET\_CURSOR\_REL

### Move Cursor Relative to Current Position

The Move Cursor Relative to Current Position routine moves the virtual cursor the specified number of rows and columns from the current virtual cursor position in a virtual display.

#### Format

SMG\$SET\_CURSOR\_REL display-id [,delta-row] [,delta-column]

#### Returns

OpenVMS usage: cond\_value  
 type: longword (unsigned)  
 access: write only  
 mechanism: by value

#### Arguments

##### display-id

OpenVMS usage: identifier  
 type: longword (unsigned)  
 access: read only  
 mechanism: by reference

Specifies the virtual display in which to move the virtual cursor. The **display-id** argument is the address of an unsigned longword that contains the display identifier.

The display identifier is returned by SMG\$CREATE\_VIRTUAL\_DISPLAY.

##### delta-row

OpenVMS usage: longword\_signed  
 type: longword (signed)  
 access: read only  
 mechanism: by reference

Specifies the number of rows to move the virtual cursor. The **delta-row** argument is the address of a signed longword that contains the number of rows to move. If omitted, the virtual cursor remains at the current row position. If **delta-row** is positive, the virtual cursor moves downward the specified number of rows. If **delta-row** is negative, the virtual cursor moves upward the specified number of rows.

##### delta-column

OpenVMS usage: longword\_signed  
 type: longword (signed)  
 access: read only  
 mechanism: by reference

Specifies the number of columns to move the cursor. The **delta-column** argument is the address of a signed longword that contains the number of columns to move. If omitted, the virtual cursor remains at the current column position. If **delta-column** is positive, the virtual cursor moves the specified

## SMG\$ Routines

### SMG\$SET\_CURSOR\_REL

number of columns to the right. If **delta-column** is negative, the virtual cursor moves the specified number of columns to the left.

#### Description

SMG\$SET\_CURSOR\_REL moves the virtual cursor the specified number of rows and columns relative to the current virtual cursor position. If the specified **delta-row** or **delta-column** causes the cursor to move outside the bounds of the virtual display, SMG\$INVROW or SMG\$INVCOL is returned.

#### Condition Values Returned

|                |                                                                                                              |
|----------------|--------------------------------------------------------------------------------------------------------------|
| SS\$NORMAL     | Normal successful completion.                                                                                |
| SMG\$INVARG    | Invalid argument.                                                                                            |
| SMG\$INVCOL    | An invalid value of <b>delta-column</b> caused the cursor to move outside the bounds of the virtual display. |
| SMG\$INVDIS_ID | Invalid <b>display-id</b> .                                                                                  |
| SMG\$INVROW    | An invalid value of <b>delta-row</b> caused the cursor to move outside the bounds of the virtual display.    |
| SMG\$WRONUMARG | Wrong number of arguments.                                                                                   |

---

## SMG\$SET\_DEFAULT\_STATE

### Set Default State

The Set Default State routine sets and/or returns the current default state for a key table.

#### Format

SMG\$SET\_DEFAULT\_STATE key-table-id [,new-state] [,old-state]

#### Returns

OpenVMS usage: cond\_value  
type: longword (unsigned)  
access: write only  
mechanism: by value

#### Arguments

##### key-table-id

OpenVMS usage: identifier  
type: longword (unsigned)  
access: read only  
mechanism: by reference

Specifies the key table in which you are setting or inquiring about a default state. The **key-table-id** argument is the address of an unsigned longword that contains the key table identifier.

The key table identifier is returned by the SMG\$CREATE\_KEY\_TABLE routine.

##### new-state

OpenVMS usage: char\_string  
type: character string  
access: read only  
mechanism: by descriptor

Specifies the new default state for the entire key table. The **new-state** argument is the address of a descriptor pointing to the new state string. The specified state name is converted to uppercase and stripped of trailing blanks before use.

##### old-state

OpenVMS usage: char\_string  
type: character string  
access: write only  
mechanism: by descriptor

Receives the existing default state name of the specified key definition table. The **old-state** argument is the address of a descriptor pointing to the string into which the old state string is written.

## SMG\$ Routines

### SMG\$SET\_DEFAULT\_STATE

#### Description

SMG\$SET\_DEFAULT\_STATE sets and/or returns the default state name for an entire key definition table. By changing the default state for an entire key definition table, you can use the keypad keys for a new set of functions. You can use the key definition table with the SMG\$READ\_COMPOSED\_LINE routine.

#### Condition Values Returned

|                  |                               |
|------------------|-------------------------------|
| SS\$ _NORMAL     | Normal successful completion. |
| SMG\$ _INVKTID   | Invalid <b>key-table-id</b> . |
| SMG\$ _INVSTANAM | Invalid state name.           |
| LIB\$ _INVSTRDES | Invalid string descriptor.    |



## SMG\$SET\_DISPLAY\_SCROLL\_REGION

### Create Display Scrolling Region

The Create Display Scrolling Region routine creates a virtual scrolling region in a virtual display.

#### Format

SMG\$SET\_DISPLAY\_SCROLL\_REGION display-id [,start-row] [,end-row]

#### Returns

OpenVMS usage: cond\_value  
type: longword (unsigned)  
access: write only  
mechanism: by value

#### Arguments

##### display-id

OpenVMS usage: identifier  
type: longword (unsigned)  
access: read only  
mechanism: by reference

Specifies the virtual display in which scrolling takes place. The **display-id** argument is the address of an unsigned longword that contains the display identifier.

The display identifier is returned by SMG\$CREATE\_VIRTUAL\_DISPLAY.

##### start-row

OpenVMS usage: longword\_signed  
type: longword (signed)  
access: read only  
mechanism: by reference

Specifies the first line of the virtual scrolling region. The **start-row** argument is the address of a signed longword that contains the starting line number. If omitted, the first line of the display is used.

##### end-row

OpenVMS usage: longword\_signed  
type: longword (signed)  
access: read only  
mechanism: by reference

Specifies the last line of the virtual scrolling region. The **end-row** argument is the address of a signed longword that contains the ending line number. If omitted, the last line of the virtual display is used.

## SMG\$ Routines

### SMG\$SET\_DISPLAY\_SCROLL\_REGION

#### Description

SMG\$SET\_DISPLAY\_SCROLL\_REGION creates a virtual scrolling region in a specified virtual display, using the specified starting and ending lines. If the **start-row** and **end-row** arguments are omitted, the entire display becomes a scrolling region. This routine does not change the appearance of the pasteboard or the virtual cursor position.

You can define part or all of a virtual display as scrolling using SMG\$SET\_DISPLAY\_SCROLL\_REGION. The behavior of scrolling in the Screen Management Facility is as follows: When you call SMG\$PUT\_LINE to write to the bottom line of the scroll region, the display does not scroll up immediately. If the display scrolled up immediately, it never would be possible to use the bottom line of the scroll region. Instead, the need for a scroll is “stored” until you issue the next SMG\$PUT\_LINE call. (The need for a scroll is stored only until your next call to a whole-line write routine, such as SMG\$PUT\_LINE, SMG\$PUT\_LINE\_WIDE, and so on.)

If you call another routine after SMG\$PUT\_LINE, such as SMG\$SET\_CURSOR\_ABS or SMG\$PUT\_CHARS, the stored need for a scroll will be discarded and text written to the bottom line of the scrolling region will overwrite the existing line.

#### Condition Values Returned

|                |                                                                         |
|----------------|-------------------------------------------------------------------------|
| SS\$NORMAL     | Normal successful completion.                                           |
| SMG\$INVARG    | The <b>end-row</b> argument is less than or equal to <b>start-row</b> . |
| SMG\$INVDIS_ID | Invalid <b>display-id</b> .                                             |
| SMG\$INVROW    | Invalid row.                                                            |
| SMG\$WRONUMARG | Wrong number of arguments.                                              |

---

## SMG\$SET\_KEYPAD\_MODE

### Set Keypad Mode

The Set Keypad Mode routine sets the terminal's numeric keypad to either numeric or applications mode.

#### Format

SMG\$SET\_KEYPAD\_MODE keyboard-id ,flags

#### Returns

OpenVMS usage: cond\_value  
type: longword (unsigned)  
access: write only  
mechanism: by value

#### Arguments

##### keyboard-id

OpenVMS usage: identifier  
type: longword (unsigned)  
access: read only  
mechanism: by reference

Specifies the virtual keyboard whose mode is to be changed. The **keyboard-id** argument is the address of an unsigned longword that contains the keyboard identifier.

The keyboard identifier is returned by SMG\$CREATE\_VIRTUAL\_KEYBOARD.

##### flags

OpenVMS usage: mask\_longword  
type: longword (unsigned)  
access: read only  
mechanism: by reference

Optional bit mask that specifies whether the keypad is to be in applications or numeric mode. The **flags** argument is the address of an unsigned longword that contains the flag. Valid values for **flags** are as follows:

|                           |                                     |
|---------------------------|-------------------------------------|
| 0                         | Keypad is set to numeric mode.      |
| SMG\$M_KEYPAD_APPLICATION | Keypad is set to applications mode. |

#### Description

SMG\$SET\_KEYPAD\_MODE sets the terminal's numeric keypad to either numeric or applications mode. In applications mode, numeric keypad keys are considered function keys and may be used as terminators. In numeric mode, these keys are equivalent to the corresponding keys on the main keyboard.

If the terminal does not support applications keypad mode, this routine has no effect.

**SMG\$ Routines**  
**SMG\$SET\_KEYPAD\_MODE**

**Condition Values Returned**

|                 |                               |
|-----------------|-------------------------------|
| SS\$_NORMAL     | Normal successful completion. |
| SMG\$_INVKBD_ID | Invalid <b>keyboard-id</b> .  |
| SMG\$_WRONUMARG | Wrong number of arguments.    |

---

## SMG\$SET\_OUT\_OF\_BAND\_ASTS

### Set Out-of-Band ASTs

The Set Out-of-Band ASTs routine either enables or disables the trapping of out-of-band control characters.

#### Format

SMG\$SET\_OUT\_OF\_BAND\_ASTS pasteboard-id,control-character-mask  
,AST-routine [,AST-argument]

#### Returns

OpenVMS usage: cond\_value  
type: longword (unsigned)  
access: write only  
mechanism: by value

#### Arguments

##### pasteboard-id

OpenVMS usage: identifier  
type: longword (unsigned)  
access: read only  
mechanism: by reference

Specifies the pasteboard for which out-of-band characters are enabled or disabled. The **pasteboard-id** argument is the address of an unsigned longword that contains the pasteboard identifier.

The pasteboard identifier is returned by SMG\$CREATE\_PASTEBOARD.

##### control-character-mask

OpenVMS usage: mask\_longword  
type: longword (unsigned)  
access: read only  
mechanism: by reference

Specifies which control characters are to be the new out-of-band control characters. The **control-character-mask** argument is the address of an unsigned longword that contains the mask. Create this mask by setting the bit that corresponds to the ASCII value of the desired character. For example, to specify that Ctrl/C (ASCII value 3) is an out-of-band control character, set bit 3 (value 8) in the **control-character-mask**. If no bits are set in this mask, then no out-of-band ASTs occur. For more information, see the *OpenVMS I/O User's Reference Manual*.

##### AST-routine

OpenVMS usage: ast\_procedure  
type: procedure value  
access: read only  
mechanism: by value

The address of an AST routine to be called when an out-of-band control character is typed at the terminal. The **AST-routine** argument is the routine's procedure value.

## SMG\$ Routines

### SMG\$SET\_OUT\_OF\_BAND\_ASTS

#### AST-argument

OpenVMS usage: user\_arg  
 type: longword (unsigned)  
 access: read only  
 mechanism: by value

The argument you supply to the AST. **AST-argument** is an unsigned longword that contains the value to be passed to the AST routine. However, the AST routine may also need to determine the out-of-band character and the **pasteboard-id** at which it was typed. Therefore, the Screen Management Facility creates a three-longword structure to hold this information and passes the address of this structure as the first argument to the AST routine. The remaining four arguments are R0, R1, PC, and PSL (on VAX systems) or PS (on Alpha systems). The Screen Management Facility stores the argument you supply in this structure.

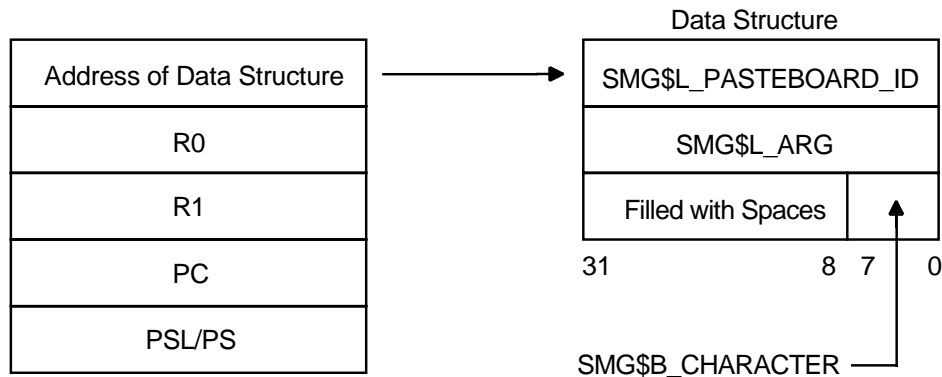

ZK-4804-GE

The first longword contains the **pasteboard-id** and has the symbolic name SMG\$\_PBD\_ID. The second longword contains the **AST-argument** and has the symbolic name SMG\$\_USER\_ARG. The third longword contains the ASCII value of the out-of-band character typed and can be accessed by way of two symbolic names: SMG\$\_B\_CHAR (the low-order byte containing the ASCII value), and SMG\$\_L\_CHAR (the longword containing the ASCII value in the low-order byte and spaces in the high-order bytes).

#### Description

SMG\$SET\_OUT\_OF\_BAND\_ASTS enables or disables the acceptance of out-of-band control characters at the specified terminal. If one of these characters is typed at the terminal, the AST routine is called.

This routine can be used to trap out-of-band characters, such as Ctrl/C, Ctrl/Y, and Ctrl/O.

#### Condition Values Returned

|                 |                                |
|-----------------|--------------------------------|
| SS\$_NORMAL     | Normal successful completion.  |
| SMG\$_INVPAS_ID | Invalid <b>pasteboard-id</b> . |
| SMG\$_WRONUMARG | Wrong number of arguments.     |

**Example**

```

!+
! This BASIC example demonstrates the use of
! SMG$SET_OUT_OF_BAND_ASTS.
!-
OPTION TYPE = EXPLICIT
OPTION CONSTANT TYPE = INTEGER

%INCLUDE "$smgdef" %FROM %LIBRARY "sys$library:basic$starlet"
%INCLUDE "$ssdef" %FROM %LIBRARY "sys$library:basic$starlet"

EXTERNAL LONG FUNCTION smg$create_pasteboard, &
 smg$create_virtual_keyboard, &
 smg$set_out_of_band_asts
EXTERNAL LONG out_band_routine

DECLARE LONG s, pasteboard_id, keyboard_id, ctrl_mask

ctrl_mask = (2**smg$k_trm_ctrlc) + (2**smg$k_trm_ctrlw) + &
 (2**smg$k_trm_ctrlz)

s = smg$create_pasteboard (pasteboard_id)
IF s <> ss$_normal THEN CALL lib$signal(s) END IF

s = smg$create_virtual_keyboard (keyboard_id)
IF s <> ss$_normal THEN CALL lib$signal(s) END IF

s = smg$set_out_of_band_asts (pasteboard_id, &
 ctrl_mask, &
 LOC(out_band_routine) BY VALUE, &
 keyboard_id BY VALUE)
IF s <> ss$_normal THEN CALL lib$signal(s) END IF

SLEEP(60)

END

SUB out_band_routine(smg$r_out_of_band_table smg_info, &
 LONG r0, LONG r1, LONG pc, LONG psl)

OPTION TYPE = EXPLICIT

%INCLUDE "$smgdef" %FROM %LIBRARY "sys$library:basic$starlet"
%INCLUDE "$ssdef" %FROM %LIBRARY "sys$library:basic$starlet"

EXTERNAL LONG FUNCTION smg$repaint_screen, &
 smg$set_keypad_mode

DECLARE LONG s, keypad_mode

IF smg_info::smg$b_char = smg$k_trm_ctrlc
THEN
 PRINT "Ctrl/C typed"
END IF

IF smg_info::smg$b_char = smg$k_trm_ctrlz
THEN
 PRINT "Ctrl/Z typed"
 STOP
END IF

IF smg_info::smg$b_char = smg$k_trm_ctrlw
THEN
 s = smg$repaint_screen (smg_info::smg$l_pbd_id)
 IF s <> ss$_normal THEN CALL lib$signal(s) END IF

 keypad_mode = smg$m_keypad_application

```

## SMG\$ Routines

### SMG\$SET\_OUT\_OF\_BAND\_ASTS

```
s = smg$set_keypad_mode (smg_info::smg$l_user_arg, keypad_mode)
IF s <> ss$_normal THEN CALL lib$signal(s) END IF
END IF
SUBEND
```



## SMG\$SET\_PHYSICAL\_CURSOR

### Set Cursor on Physical Screen

The Set Cursor on Physical Screen routine moves the physical cursor to the specified position on the pasteboard.

#### Format

```
SMG$SET_PHYSICAL_CURSOR pasteboard-id ,pasteboard-row
 ,pasteboard-column
```

#### Returns

OpenVMS usage: cond\_value  
type: longword (unsigned)  
access: write only  
mechanism: by value

#### Arguments

##### **pasteboard-id**

OpenVMS usage: identifier  
type: longword (unsigned)  
access: read only  
mechanism: by reference

Specifies the pasteboard whose physical cursor is to move. The **pasteboard-id** argument is the address of an unsigned longword that contains the pasteboard identifier.

The pasteboard identifier is returned by SMG\$CREATE\_PASTEBOARD.

##### **pasteboard-row**

OpenVMS usage: longword\_signed  
type: longword (signed)  
access: read only  
mechanism: by reference

Specifies the row to which the physical cursor moves. The **pasteboard-row** argument is the address of a signed longword that contains the row number.

##### **pasteboard-column**

OpenVMS usage: longword\_signed  
type: longword (signed)  
access: read only  
mechanism: by reference

Specifies the column to which the physical cursor moves. The **pasteboard-column** argument is the address of a signed longword that contains the column number.

## SMG\$ Routines

### SMG\$SET\_PHYSICAL\_CURSOR

#### Description

SMG\$SET\_PHYSICAL\_CURSOR moves the physical cursor to the specified row and column position on the specified pasteboard. This routine should not be used when pasteboard batching is in effect.

#### Condition Values Returned

|                 |                                |
|-----------------|--------------------------------|
| SS\$_NORMAL     | Normal successful completion.  |
| SMG\$_INVARG    | Invalid column.                |
| SMG\$_INVPAS_ID | Invalid <b>pasteboard-id</b> . |
| SMG\$_WRONUMARG | Wrong number of arguments.     |

## SMG\$SET\_TERM\_CHARACTERISTICS

### Change Terminal Characteristics

The Change Terminal Characteristics routine changes or retrieves the terminal characteristics for a given pasteboard.

#### Format

```
SMG$SET_TERM_CHARACTERISTICS pasteboard-id
 [,on-characteristics1] [,on-characteristics2]
 [,off-characteristics1] [,off-characteristics2]
 [,old-characteristics1] [,old-characteristics2]
 [,on-characteristics3] [,off-characteristics3]
 [,old-characteristics3]
```

#### Returns

OpenVMS usage: cond\_value  
 type: longword (unsigned)  
 access: write only  
 mechanism: by value

#### Arguments

##### pasteboard-id

OpenVMS usage: identifier  
 type: longword (unsigned)  
 access: read only  
 mechanism: by reference

Specifies the pasteboard whose characteristics are to be changed or retrieved. The **pasteboard-id** argument is the address of an unsigned longword that contains the pasteboard identifier.

The pasteboard identifier is returned by SMG\$CREATE\_PASTEBOARD.

##### on-characteristics1

OpenVMS usage: mask\_longword  
 type: longword (unsigned)  
 access: read only  
 mechanism: by reference

Bit mask that specifies the terminal characteristics to be set from \$TTDEF. The **on-characteristics1** argument is the address of an unsigned longword that contains the bit mask.

##### on-characteristics2

OpenVMS usage: mask\_longword  
 type: longword (unsigned)  
 access: read only  
 mechanism: by reference

Bit mask that specifies the terminal characteristics to be set from \$TT2DEF. The **on-characteristics2** argument is the address of an unsigned longword that contains the bit mask.

## SMG\$ Routines

### SMG\$SET\_TERM\_CHARACTERISTICS

#### **off-characteristics1**

OpenVMS usage: mask\_longword  
type: longword (unsigned)  
access: read only  
mechanism: by reference

Bit mask that specifies the terminal characteristics to be reset from \$TTDEF. The **off-characteristics1** argument is the address of an unsigned longword that contains the bit mask.

#### **off-characteristics2**

OpenVMS usage: mask\_longword  
type: longword (unsigned)  
access: read only  
mechanism: by reference

Bit mask that specifies the terminal characteristics to be reset from \$TT2DEF. The **off-characteristics2** argument is the address of an unsigned longword that contains the bit mask.

#### **old-characteristics1**

OpenVMS usage: mask\_longword  
type: longword (unsigned)  
access: write only  
mechanism: by reference

Retrieves the current terminal characteristics in the first group. The **old-characteristics1** argument is the address of an unsigned longword that contains the bit mask.

#### **old-characteristics2**

OpenVMS usage: mask\_longword  
type: longword (unsigned)  
access: write only  
mechanism: by reference

Retrieves the current terminal characteristics in the second group. The **old-characteristics2** argument is the address of an unsigned longword that contains the bit mask.

#### **on-characteristics3**

OpenVMS usage: mask\_longword  
type: longword (unsigned)  
access: read only  
mechanism: by reference

Bit mask that specifies the terminal characteristics to be set from \$TT3DEF. The **on-characteristics3** argument is the address of an unsigned longword that contains the bit mask.

## SMG\$ Routines

### SMG\$SET\_TERM\_CHARACTERISTICS

#### off-characteristics3

OpenVMS usage: mask\_longword  
type: longword (unsigned)  
access: read only  
mechanism: by reference

Bit mask that specifies the terminal characteristics to be reset from \$TT3DEF. The **off-characteristics3** argument is the address of an unsigned longword that contains the bit mask.

#### old-characteristics3

OpenVMS usage: mask\_longword  
type: longword (unsigned)  
access: write only  
mechanism: by reference

Retrieves the current terminal characteristics in the third group. The **old-characteristics3** argument is the address of an unsigned longword that contains the bit mask.

## Description

SMG\$SET\_TERM\_CHARACTERISTICS changes or retrieves the terminal characteristics for a given pasteboard. The characteristics are defined by the \$TTDEF and \$TT2DEF macro modules in system symbol libraries supplied by Compaq. A benefit of using this routine is that it allows you to control multiple terminal characteristics in a single routine call.

## Condition Values Returned

|                |                               |
|----------------|-------------------------------|
| SS\$NORMAL     | Normal successful completion. |
| SMG\$NOT_A_TRM | Pasteboard is not a terminal. |
| SS\$_xyz       | Errors from LIB\$QIOW.        |

## Example

```
10 !+
 ! This VAX BASIC program demonstrates the use of the
 ! SMG$SET_TERM_CHARACTERISTICS routine.
 !-

 OPTION TYPE = EXPLICIT
 OPTION CONSTANT TYPE = INTEGER

 %INCLUDE "$SSDEF" %FROM %LIBRARY "SYS$LIBRARY:BASIC$STARLET"
 %INCLUDE "$TTDEF" %FROM %LIBRARY "SYS$LIBRARY:BASIC$STARLET"
 %INCLUDE "$TT2DEF" %FROM %LIBRARY "SYS$LIBRARY:BASIC$STARLET"

 DECLARE LONG S, PASTEBOARD_ID, ON_1, ON_2, OFF_1, OFF_2, OLD_1, OLD_2

 EXTERNAL LONG FUNCTION LIB$SIGNAL(LONG BY VALUE), &
 SMG$CREATE_PASTEBOARD(LONG), &
 SMG$SET_TERM_CHARACTERISTICS(LONG, LONG, &
 LONG, LONG, LONG, LONG, LONG)

 !+
 ! Create the pasteboard
 !-

 S = SMG$CREATE_PASTEBOARD(PASTEBOARD_ID)
 IF S <> SS$NORMAL THEN CALL LIB$SIGNAL(S) END IF
```

## SMG\$ Routines

### SMG\$SET\_TERM\_CHARACTERISTICS

```
!+
! Terminal characteristics to be set
!-

ON_1 = TT$M_LOWER
ON_2 = TT2$M_EDITING + TT2$M_EDIT

!+
! Terminal characteristics to be reset
!-

OFF_1 = TT$M_WRAP + TT$M_MECHTAB
OFF_2 = TT2$M_PASTHRU + TT2$M_INSERT

!+
! Change the characteristics of the terminal line associated
! with the pasteboard. They will be reset at image exit or when
! SMG$DELETE_PASTEBOARD is called. The previous characteristics
! are returned in OLD_1 and OLD_2.
!-

S = SMG$SET_TERM_CHARACTERISTICS(PASTEBOARD_ID, ON_1, ON_2, &
 OFF_1, OFF_2, OLD_1, OLD_2)
IF S <> SS$_NORMAL THEN CALL LIB$SIGNAL(S) END IF

IF (OLD_1 AND TT$M_WRAP) <> 0
THEN
 PRINT "WRAP was set"
ELSE
 PRINT "NOWRAP was set"
END IF

IF (OLD_2 AND TT2$M_ANSICRT) <> 0
THEN
 PRINT "Pasteboard is an ANSI terminal"
ELSE
 PRINT "Pasteboard is not an ANSI terminal"
END IF

END
```

---

## SMG\$SNAPSHOT

### Write Snapshot

The Write Snapshot routine writes the current pasteboard buffer to the file or hardcopy terminal specified by the pasteboard identifier.

#### Format

SMG\$SNAPSHOT pasteboard-id [,flags]

#### Returns

OpenVMS usage: cond\_value  
 type: longword (unsigned)  
 access: write only  
 mechanism: by value

#### Arguments

##### pasteboard-id

OpenVMS usage: identifier  
 type: longword (unsigned)  
 access: read only  
 mechanism: by reference

Specifies the file or hardcopy terminal to receive the contents of the pasteboard buffer. The **pasteboard-id** argument is the address of an unsigned longword that contains the pasteboard identifier. The output device associated with **pasteboard-id** is specified by the **output-device** argument of SMG\$CREATE\_PASTEBOARD.

##### flags

OpenVMS usage: mask\_longword  
 type: longword (unsigned)  
 access: read only  
 mechanism: by reference

Optional bit mask that specifies whether a form feed is passed. The **flags** argument is the address of an unsigned longword containing the flag. Valid values for **flags** are as follows:

|                  |                                       |
|------------------|---------------------------------------|
| 0                | No form feed is passed.               |
| SMG\$M_FORM_FEED | The first line passed is a form feed. |

#### Description

SMG\$SNAPSHOT is meant to be used when output to the pasteboard is controlled by OpenVMS RMS — that is, when the output device is a file, a hardcopy terminal, or a terminal of unknown type. In this case, the pasteboard information is stored internally and is sent to either the file, hardcopy terminal, or the terminal of unknown type whenever SMG\$SNAPSHOT is called. This allows you to capture pasteboard images in a file.

## **SMG\$ Routines**

### **SMG\$SNAPSHOT**

Pasteboard batching does not affect the SMG\$SNAPSHOT routine. If you enable pasteboard batching with the SMG\$BEGIN\_PASTEBOARD\_UPDATE routine, a buffer is created that saves all output to a pasteboard until you disable batching with a call to SMG\$END\_PASTEBOARD\_UPDATE. When you call SMG\$SNAPSHOT, you get a snapshot of that current pasteboard buffer — not what is possibly a stale screen image.

This routine must be used if the SMG\$\_WILUSERMS error is returned by other SMG\$ routines.

### **Condition Values Returned**

|                 |                                                                                     |
|-----------------|-------------------------------------------------------------------------------------|
| SS\$_NORMAL     | Normal successful completion.                                                       |
| SMG\$_NOTRMSOUT | Successful completion. No action was taken because output is not controlled by RMS. |

Any condition value returned by RMS.



---

## SMG\$SNAPSHOT\_TO\_PRINTER

### Write Snapshot to Printer

The Write Snapshot to Printer routine writes the current pasteboard buffer to the printer attached to the terminal.

#### Format

SMG\$SNAPSHOT\_TO\_PRINTER pasteboard-id ,device-type [,flags]

#### Returns

OpenVMS usage: cond\_value  
type: longword (unsigned)  
access: write only  
mechanism: by value

#### Arguments

##### pasteboard-id

OpenVMS usage: identifier  
type: longword (unsigned)  
access: read only  
mechanism: by reference

Identifier of the pasteboard whose snapshot will be sent to a printer. The **pasteboard-id** argument is the address of an unsigned longword that contains the pasteboard identifier.

##### device-type

OpenVMS usage: device\_name  
type: character string  
access: read only  
mechanism: by descriptor

Specifies the type of printer to which the output associated with this pasteboard will be written. The **device-type** argument is the address of a descriptor that points to the name of the output device. Valid values for this argument (for example, LA50) are defined in SYSSYSTEM:TERMTABLE.TXT.

##### flags

OpenVMS usage: mask\_longword  
type: longword (unsigned)  
access: read only  
mechanism: by reference

Optional bit mask that specifies whether a form feed is passed. The **flags** argument is the address of an unsigned longword containing the flag. The valid value for the **flags** argument is as follows:

SMG\$M\_FORM\_FEED            Output a form feed as the first record.

## **SMG\$ Routines**

### **SMG\$SNAPSHOT\_TO\_PRINTER**

#### **Description**

SMG\$SNAPSHOT\_TO\_PRINTER writes the current pasteboard buffer to the specified printer. This routine returns SMG\$\_OPNOTSUP if the output device (terminal) does not have a printer attached to its printer port.

Pasteboard batching does not affect the SMG\$SNAPSHOT\_TO\_PRINTER routine. If you enable pasteboard batching with the SMG\$BEGIN\_PASTEBOARD\_UPDATE routine, a buffer is created that saves all output to a pasteboard until you disable batching with a call to SMG\$END\_PASTEBOARD\_UPDATE. When you call SMG\$SNAPSHOT\_TO\_PRINTER, you get a snapshot of that current pasteboard buffer — not what is possibly a stale screen image.

#### **Condition Values Returned**

|                |                               |
|----------------|-------------------------------|
| SS\$_NORMAL    | Normal successful completion. |
| SMG\$_OPNOTSUP | Operation not supported.      |

Any condition value returned by LIB\$GET\_VM, LIB\$FREE\_VM, or \$QIOW.

---

## SMG\$UNPASTE\_VIRTUAL\_DISPLAY

### Remove Virtual Display

The Remove Virtual Display routine removes a virtual display from a pasteboard.

#### Format

SMG\$UNPASTE\_VIRTUAL\_DISPLAY display-id ,pasteboard-id

#### Returns

OpenVMS usage: cond\_value  
type: longword (unsigned)  
access: write only  
mechanism: by value

#### Arguments

##### display-id

OpenVMS usage: identifier  
type: longword (unsigned)  
access: read only  
mechanism: by reference

Specifies the virtual display to be removed from a pasteboard. The **display-id** argument is the address of an unsigned longword that contains the display identifier.

The display identifier is returned by SMG\$CREATE\_VIRTUAL\_DISPLAY.

##### pasteboard-id

OpenVMS usage: identifier  
type: longword (unsigned)  
access: read only  
mechanism: by reference

Specifies the pasteboard from which the virtual display is removed. The **pasteboard-id** argument is the address of an unsigned longword that contains the pasteboard identifier.

#### Description

SMG\$UNPASTE\_VIRTUAL\_DISPLAY removes the specified display from the specified pasteboard, and thus from the screen associated with the pasteboard. This routine does not destroy the virtual display or its contents; it only removes its association with a particular pasteboard and its visibility on the screen. Any text occluded by the specified virtual display becomes visible again.

#### Condition Values Returned

|             |                                                                                            |
|-------------|--------------------------------------------------------------------------------------------|
| SS\$NORMAL  | Normal successful completion.                                                              |
| SMG\$INVARG | Invalid argument. The specified virtual display is not pasted to the specified pasteboard. |

**SMG\$ Routines**  
**SMG\$UNPASTE\_VIRTUAL\_DISPLAY**

|                 |                                                                          |
|-----------------|--------------------------------------------------------------------------|
| SMG\$_INVDIS_ID | Invalid <b>display-id</b> .                                              |
| SMG\$_INVPAS_ID | Invalid <b>pasteboard-id</b> .                                           |
| SMG\$_NOTPASTED | The specified virtual display is not pasted to the specified pasteboard. |
| SMG\$_WRONUMARG | Wrong number of arguments.                                               |

---

# Index

## A

---

Argument substitutions, 5-14  
Arithmetic operations, 5-15  
AST reentrant, 4-1  
ASTs (asynchronous system traps)  
    reentrant, 4-1  
Asynchronous events, 4-1  
Asynchronous system traps  
    See ASTs

## B

---

Buffering modes, 2-16

## C

---

Capability fields, 5-3  
    Boolean, 5-4  
    characters with normal ASCII value, 5-13  
    creating, 5-16  
    delimiters, 5-3  
    nonprinting characters, 5-13  
    numeric, 5-5  
    padding, 5-14  
    string, 5-6  
    used by SMG, 5-21  
    user-defined renditions, 5-12  
Character-oriented output, 2-8  
Compaq FMS  
    See FMS  
Compaq GKS  
    See GKS  
Composition operations, 2-1  
Cursors  
    moving, 4-3  
    turning on and off, SMG-359

## D

---

Deletion operations, 2-7  
Drawing characters, 2-11  
Drawing lines, 2-11

## E

---

Erasure operations, 2-8  
Exit handlers, 4-3

## F

---

FMS (Forms Management System), 1-3, 4-1  
Foreign terminals, 5-1

## G

---

GKS (Graphical Kernel System), 1-3, 4-1

## I

---

If state, 3-3  
Insertion operations, 2-8

## L

---

Line compositions, 3-2  
Line-oriented output, 2-8  
Locators, obtaining data from, 3-2

## M

---

Menus, 2-13  
    creating, 2-14  
    deleting, 2-14  
    selecting, 2-14  
Mouse, obtaining data from, 3-2  
Multiple processes, calling SMG\$ routines with,  
    4-1

## O

---

Occlusion, 2-5  
Operational controls, 2-16  
Output operations, batching of, 2-17

## P

---

Pasteboards, 1-4  
Processes  
    handling multiple calls to SMG\$ routines, 4-1

## R

---

### Reentrancy

AST, 4-1

### Reentrant ASTs, 4-1

### Renditions

changing for virtual display, 2-9

## S

---

### Screen management, 1-1

### Screens

minimal update, 2-16

### Scroll modes

jump, SMG-359

smooth, SMG-359

SMG\$ADD\_KEY\_DEF routine, 3-3, SMG-3

SMG\$BEGIN\_DISPLAY\_UPDATE routine, 2-17, SMG-6

SMG\$BEGIN\_PASTEBOARD\_UPDATE routine, 2-17, SMG-7

SMG\$CANCEL\_INPUT routine, 1-7, 3-1, SMG-8

SMG\$CHANGE\_PBD\_CHARACTERISTICS routine, 1-5, SMG-9

SMG\$CHANGE\_RENDITION routine, 2-9, SMG-12

SMG\$CHANGE\_VIEWPORT routine, 2-13, SMG-15

SMG\$CHANGE\_VIRTUAL\_DISPLAY routine, 2-9, SMG-21

SMG\$CHECK\_FOR\_OCCLUSION routine, 2-5, SMG-24

SMG\$CONTROL\_MODE routine, 2-16, SMG-28

SMG\$COPY\_VIRTUAL\_DISPLAY routine, SMG-32

SMG\$CREATE\_KEY\_TABLE routine, 3-3, SMG-38

SMG\$CREATE\_MENU routine, 2-14, SMG-39

SMG\$CREATE\_PASTEBOARD routine, 1-4, 6-2, SMG-43

SMG\$CREATE\_SUBPROCESS routine, SMG-47

SMG\$CREATE\_VIEWPORT routine, 2-12, SMG-52

SMG\$CREATE\_VIRTUAL\_DISPLAY routine, 1-6, SMG-56

SMG\$CREATE\_VIRTUAL\_KEYBOARD routine, 1-7, 3-1, SMG-61

SMG\$CURSOR\_COLUMN routine, 2-6, SMG-65

SMG\$CURSOR\_ROW routine, 2-6, SMG-66

SMG\$DEFINE\_KEY routine, 3-3, SMG-67

SMG\$DELETE\_CHARS routine, 2-7, SMG-69

SMG\$DELETE\_KEY\_DEF routine, 3-3, SMG-74

SMG\$DELETE\_LINE routine, 2-7, SMG-76

SMG\$DELETE\_MENU routine, 2-14, SMG-80

SMG\$DELETE\_PASTEBOARD routine, 1-5, SMG-81

SMG\$DELETE\_SUBPROCESS routine, SMG-83

SMG\$DELETE\_VIEWPORT routine, 2-12, SMG-84

SMG\$DELETE\_VIRTUAL\_DISPLAY routine, 1-6, 2-4, 6-2, SMG-85

SMG\$DELETE\_VIRTUAL\_KEYBOARD routine, 3-1, SMG-86

SMG\$DEL\_TERM\_TABLE routine, 5-3, SMG-87

SMG\$DISABLE\_BROADCAST\_TRAPPING routine, SMG-88

SMG\$DISABLE\_UNSOLICITED\_INPUT routine, SMG-98

SMG\$DRAW\_CHAR routine, 2-11, SMG-100

SMG\$DRAW\_LINE routine, 2-11, SMG-104

SMG\$DRAW\_RECTANGLE routine, 2-11, SMG-109

SMG\$ENABLE\_UNSOLICITED\_INPUT routine, 4-2, SMG-114

SMG\$END\_DISPLAY\_UPDATE routine, 2-17, SMG-117

SMG\$END\_PASTEBOARD\_UPDATE routine, 2-17, SMG-118

SMG\$ERASE\_CHARS routine, 2-8, SMG-119

SMG\$ERASE\_COLUMN routine, 2-8, SMG-123

SMG\$ERASE\_DISPLAY routine, 2-8, SMG-125

SMG\$ERASE\_LINE routine, 2-8, SMG-130

SMG\$ERASE\_PASTEBOARD routine, 1-5, SMG-134

SMG\$EXECUTE\_COMMAND routine, SMG-136

SMG\$FIND\_CURSOR\_DISPLAY routine, SMG-138

SMG\$FLUSH\_BUFFER routine, 2-16, SMG-140

SMG\$FLUSH\_DISPLAY\_UPDATE routine, 2-17, SMG-141

SMG\$GET\_BROADCAST\_MESSAGE routine, 4-2, SMG-142

SMG\$GET\_CHAR\_AT\_PHYSICAL\_CURSOR routine, SMG-144

SMG\$GET\_DISPLAY\_ATTR routine, SMG-146

SMG\$GET\_KEYBOARD\_ATTRIBUTES routine, 3-2, SMG-149

SMG\$GET\_KEY\_DEF routine, SMG-152

SMG\$GET\_NUMERIC\_DATA routine, 5-2, SMG-155

SMG\$GET\_PASTEBOARD\_ATTRIBUTES routine, 1-5, SMG-157

SMG\$GET\_PASTING\_INFO routine, SMG-160

SMG\$GET\_TERM\_DATA routine, 5-2, SMG-162

SMG\$GET\_VIEWPORT\_CHAR routine, 2-13, SMG-164

SMG\$HOME\_CURSOR routine, 2-7, SMG-168

SMG\$INIT\_TERM\_TABLE routine, 5-2, SMG-170

SMG\$INIT\_TERM\_TABLE\_BY\_TYPE routine, 5-2, SMG-172  
 SMG\$INSERT\_CHARS routine, 2-8, SMG-174  
 SMG\$INSERT\_LINE routine, 2-8, SMG-180  
 SMG\$INVALIDATE\_DISPLAY routine, SMG-186  
 SMG\$KEYCODE\_TO\_NAME routine, 3-6, SMG-187  
 SMG\$LABEL\_BORDER routine, SMG-189  
 SMG\$LIST\_KEY\_DEFS routine, SMG-195  
 SMG\$LIST\_PASTEBOARD\_ORDER routine, 2-5, SMG-198  
 SMG\$LIST\_PASTING\_ORDER routine, 2-5, SMG-200  
 SMG\$LOAD\_KEY\_DEFS routine, 3-3, SMG-202  
 SMG\$LOAD\_VIRTUAL\_DISPLAY routine, 2-15, SMG-204  
 SMG\$MOVE\_TEXT routine, 2-4, SMG-206  
 SMG\$MOVE\_VIRTUAL\_DISPLAY routine, 2-3, SMG-209  
 SMG\$NAME\_TO\_KEYCODE routine, 3-6, SMG-212  
 SMG\$PASTE\_VIRTUAL\_DISPLAY routine, 2-1, SMG-214  
 SMG\$POP\_VIRTUAL\_DISPLAY routine, 2-4, 6-2, SMG-216  
 SMG\$PRINT\_PASTEBOARD routine, SMG-218  
 SMG\$PUT\_CHARS routine, 2-8, SMG-220  
 SMG\$PUT\_CHARS\_HIGHWIDE routine, 2-8, SMG-225  
 SMG\$PUT\_CHARS\_MULTI routine, 2-8, SMG-228  
 SMG\$PUT\_CHARS\_WIDE routine, 2-8, SMG-231  
 SMG\$PUT\_HELP\_TEXT routine, SMG-234  
 SMG\$PUT\_LINE routine, 2-9, SMG-237  
 SMG\$PUT\_LINE\_HIGHWIDE routine, 2-9, SMG-243  
 SMG\$PUT\_LINE\_MULTI routine, 2-9, SMG-246  
 SMG\$PUT\_LINE\_WIDE routine, 2-9, SMG-251  
 SMG\$PUT\_PASTEBOARD routine, SMG-256  
 SMG\$PUT\_STATUS\_LINE routine, SMG-258  
 SMG\$READ\_COMPOSED\_LINE routine, 1-7, 3-1, 3-2, SMG-260  
 SMG\$READ\_FROM\_DISPLAY routine, 2-12, SMG-265  
 SMG\$READ\_KEYSTROKE routine, 3-1, SMG-270  
 SMG\$READ\_LOCATOR routine, SMG-278  
 SMG\$READ\_STRING routine, 1-7, 3-1, SMG-282  
 SMG\$READ\_VERIFY routine, 3-1, SMG-293  
 SMG\$REMOVE\_LINE routine, 2-11, SMG-300  
 SMG\$REPAINT\_LINE routine, SMG-302  
 SMG\$REPAINT\_SCREEN routine, SMG-304  
 SMG\$REPASTE\_VIRTUAL\_DISPLAY routine, 2-3, SMG-308  
 SMG\$REPLACE\_INPUT\_LINE routine, SMG-314  
 SMG\$RESTORE\_PHYSICAL\_SCREEN routine, 6-3, SMG-317  
 SMG\$RETURN\_CURSOR\_POS routine, 2-6, SMG-319  
 SMG\$RETURN\_INPUT\_LINE routine, SMG-321  
 SMG\$RING\_BELL routine, SMG-324  
 SMG\$SAVE\_PHYSICAL\_SCREEN routine, 6-3, SMG-325  
 SMG\$SAVE\_VIRTUAL\_DISPLAY routine, 2-15, SMG-327  
 SMG\$SCROLL\_DISPLAY\_AREA routine, SMG-329  
 SMG\$SCROLL\_VIEWPORT routine, 2-13, SMG-332  
 SMG\$SELECT\_FROM\_MENU routine, 2-14, SMG-339  
 SMG\$SET\_BROADCAST\_TRAPPING routine, 4-2, SMG-355  
 SMG\$SET\_CURSOR\_ABS routine, 2-7, SMG-357  
 SMG\$SET\_CURSOR\_MODE routine, SMG-359  
 SMG\$SET\_CURSOR\_REL routine, 2-7, SMG-361  
 SMG\$SET\_DEFAULT\_STATE routine, SMG-363  
 SMG\$SET\_DISPLAY\_SCROLL\_REGION routine, SMG-365  
 SMG\$SET\_KEYPAD\_MODE routine, 3-2, SMG-367  
 SMG\$SET\_OUT\_OF\_BAND\_ASTS routine, 4-2, SMG-369  
 SMG\$SET\_PHYSICAL\_CURSOR routine, SMG-373  
 SMG\$SET\_TERM\_CHARACTERISTICS routine, SMG-375  
 SMG\$SNAPSHOT routine, 2-15, SMG-379  
 SMG\$SNAPSHOT\_TO\_PRINTER routine, 2-15, SMG-381  
 SMG\$UNPASTE\_VIRTUAL\_DISPLAY routine, 2-2, 6-2, SMG-383  
 States, 3-3  
 Subprocesses, 4-2  
     creating, 4-2  
     deleting, 4-2  
     executing commands, 4-3

## T

Tablets, obtaining data from, 3-2  
 Terminals  
     foreign, input support, 5-22  
     support for SET and SHOW TERMINAL commands, 5-23  
     third-party, support for, 5-1  
 Terminators, 3-3  
     codes, 3-6  
 TERMTABLE.EXE file, 5-1, 5-16  
     creating, 5-20

TERMTABLE.TXT file, 5-1, 5-16

## V

---

Viewports, 1-6, 2-12 to 2-13  
  changing characteristics, 2-13  
  creating, 2-12  
  deleting, 2-12  
  moving, 2-13  
  pasting, 2-13  
  scrolling, 2-13  
  unpasting, 2-13  
Virtual displays, 1-5  
  changing rendition of, 2-9

  outputting through, 2-5  
  reading from, 2-12  
  saving, 2-15

Virtual keyboards, 1-7, 3-1 to 3-2  
  definition of, 3-1  
  inputting through, 3-1  
  obtaining data from, 3-1  
  retrieving characteristics, 3-2  
  setting characteristics, 3-2

## W

---

Writing operations, 2-8